









Built-in Household Appliances
2016-2017

VESTEL



		
Company Profile 02-03	Global Operations 04-05	Refrigerators 06-16

		
60cm Dishwashers 17-47	45 cm Dishwashers 48-59	Ovens 60-105

		
Hobs 106-169	Specifications 170-203	Addresses 207



Company Profile

Vestel City, which comprises nine plants located in Manisa, is amongst the biggest industrial complexes of the world.

As one of the leading enterprises in Turkey, Vestel is a major player in consumer electronics, mobile technologies, household appliances, professional displays and LED lighting with renowned products, including refrigerators, washing machines, cooking appliances, dishwashers, air conditioners, water heaters, television sets, educational, hospitality and digital signage solutions, digital set-top boxes, tablet PCs, and smart phones.

The company is recognised for its cutting-edge designs, high product quality, large production capacity, and superior market share growth.

Vestel is one of the ten biggest household appliance manufacturers in Europe, with its new product development ability, flexibility in production, and fast response to clients' demands.



Operating with an annual capacity of 3.2 million units, the company's two refrigerator plants produce a variety of models ranging from french door, no-frost, combi, double door, single door, to table top fridges and freezers, as well as built-in models.

Achieving similar success with washing machines, Vestel is able to produce 2.5 million units a year, with models ranging from 4 kg to 9 kg drum capacities. The group added washer

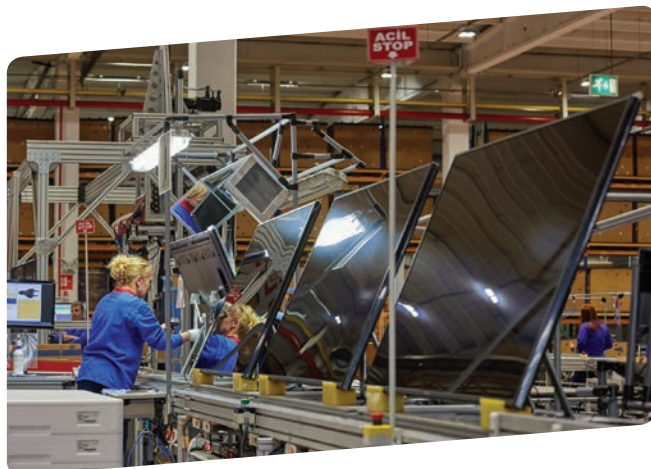
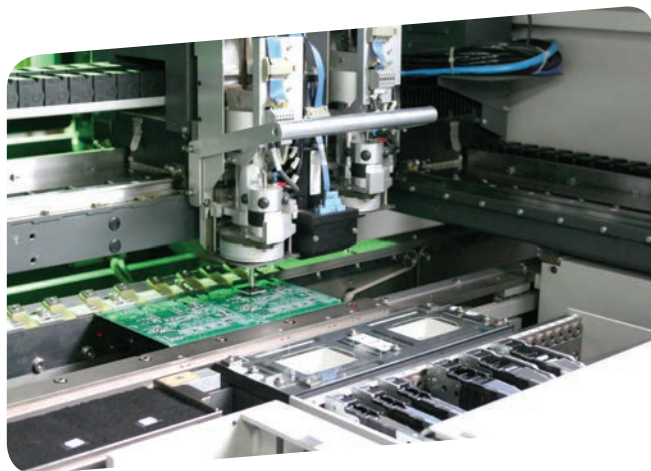

dryers to the product range in 2012. The plant for cooking appliances operates with an annual capacity of 2.2 million units, producing free-standing cookers, built-in hobs and ovens.

The household appliances product range includes free standing, semi and fully integrated dishwashers. The plant has the capacity to produce 2.5 million units a year.

In addition, the air conditioner factory is capable of producing 750,000 units of split-type models.

Vestel is the first company in Turkey operating two manufacturing plants in Russia for the production of refrigerators, washing machines, and televisions with the aim of becoming a leader in CIS countries.

Vestel Trade, the company responsible for the marketing and sales of Vestel products overseas, exports 73% percent of its production under leading Japanese and European brands to 152 countries.

Vestel Trade has achieved export sales of 8.3 million units of electronics and 4.8 million units of household appliances.

Distributing its products to seven continents, Vestel takes its place as a world-class company.

🌐 Global Operations



Manufacturing & Assembly Plants

Refrigerator, Washing Machine, Dishwasher, Cooking Appliances, Air Conditioner, Water Heater Manisa, Turkey

LED TV, HD, IP/OTT, PVR Set-top Boxes – Manisa, Turkey

Professional Displays, Tablet PC, Smart Phone, LED lighting – Manisa Turkey

Marketing & Sales Companies

Vestel Trade, Turkey

Vestel France, France

Vestel Germany, Germany

Vestel UK, The UK

Vestel Iberia, Spain

Gruppo Industriale Vesit, Italy

Vestel Benelux, The Netherlands

Vestel CIS Ltd, Russia

Vestel Electronica, Romania

Vestel Scandinavia, Finland

Vestfrost Household, Denmark

Vestel Central Asia, Kazakhstan

R&D Centers

Manisa, Turkey

Istanbul, Turkey

Bristol, UK

Shanghai, China

Refrigerators





DOOR ON DOOR MODELS

Cabinet door is mounted directly onto the refrigerator door and with the help of the hinge, the refrigerator opens wider and closes automatically.



SLIDING DOOR MODELS

Cabinet door is Connected to the refrigerator door with sliding rails.



SAFETY GLASS

Glass shelves are made of safety glass and can hold upto 20 kg in weight.



REMOVABLE MAGNETIC GASKET

The gasket prevents growth of bacteria and microorganisms.



EASY LOCK FREEZER

Mechanism of the handle enables easy opening and closing of the door.

Red mark on the door indicates and warns the user when the freezer door is left open.



CONTROL PANEL

Warning lights advise current freezer status and internal temperature rise.

Quick Service Control Box Thermostat and other controls are easily reachable for service purposes.

ENERGY EFFICIENCY

Vestel built-in fridges and freezers are available with or A++, A+ or A energy class.



REVERSIBLE DOORS

All Vestel refrigerator doors can be opened to the left or right with a simple adjustment.

Wire shelves and opaque white accessories are also available for all models.

STAR RATING 

All Vestel freezers have 4 star rating which allows you to safely freeze fresh food and deeply store frozen food.



BGN 2795

BUILT-IN SINGLE DOOR

Niche 1780mm
Sliding door
Door on Door
Reversible doors

FRIDGE

Turbo fan air cooling
Air Duct
Safety Glass Shelves
1 Glass Shelf over Crisper
2 Crispers
Automatic Defrosting
Humidity Controller

TECHNICAL DATA

Energy Class: A++/A+
Gross/Net Volume: 303lt/300lt
Product Dimensions (HxWxD): 1770x540x545

INDOOR FEATURES

1 Dairy Rack
1 Egg Holder
3 Transparent shelves
1 Bottle Shelf

OPTIONAL FEATURES

Electronic Head Panel Display
LED Lighting
Wine Shelf
Adjustable Door Rack
MaxiFresh Preserver

A++

A+

BGN 2791

BUILT-IN SINGLE DOOR

Niche 1780mm
Sliding door
Door on Door
Reversible doors

TECHNICAL DATA

Energy Class: A++/A+
Gross/Net Volume: 221lt/197lt
Product Dimensions (HxWxD): 1770x540x545

FREEZER

4 star freezer
7 Freezer Compartments + 1 Flap
Automatic Defrosting

OPTIONAL FEATURES

Sliding Icematic
LED Lighting



A++

A+



BGN 2761

BUILT-IN COMBI

Niche 1780mm, Sliding door
Door on Door, Reversible doors

FREEZER

Automatic Defrosting
4 star freezer, 1 Ice Box
3 Freezer Compartments

TECHNICAL DATA

Energy Class: A++/A+
Gross/Net Volume: 251lt/237lt
Net Fridge/Freezer Volume: 179lt/58lt
Product Dimensions (HxWxD):
1770x540x545

INDOOR FEATURES

1 Dairy Rack, 1 Egg Holder
2 Transparent shelves, 1 Bottle Shelf

FRIDGE

Safety Glass Shelves
1 Glass Shelf over Crisper, 1 Crisper
Automatic Defrosting
Humidity Controller

OPTIONAL FEATURES

Electronic Head Panel Display
Turbo Fan Air Cooling
Air Duct
LED Lighting
Wine Shelf
Adjustable Door Rack
MaxiFresh Preserver

A++

A+

BGN 2760

BUILT-IN COMBI

Niche 1780mm, Sliding door
Door on Door, Reversible doors

FREEZER

4 star freezer, 1 Ice Box
3 Freezer Compartments

TECHNICAL DATA

Energy Class: A++/A+
Gross/Net Volume: 251lt/243lt
Net Fridge/Freezer Volume: 179lt/64lt
Product Dimensions (HxWxD):
1770x540x545

INDOOR FEATURES

1 Dairy Rack, 1 Egg Holder
2 Transparent shelves, 1 Bottle Shelf

FRIDGE

Safety Glass Shelves
1 Glass Shelf over Crisper, 1 Crisper
Humidity Controller

OPTIONAL FEATURES

Wine Shelf
Adjustable Door Rack
MaxiFresh Preserver



A++

A+



BGN 2751

BUILT-IN COMBI

Niche 1780mm, Sliding door
Door on Door, Reversible doors

FREEZER

Automatic Defrosting
4 star freezer, 1 Ice Box
4 Freezer Compartments

TECHNICAL DATA

Energy Class: A++/A+
Gross/Net Volume: 245lt/227lt
Net Fridge/Freezer Volume: 146lt/81lt
Product Dimensions (HxWxD): 1770x540x545

INDOOR FEATURES

1 Dairy Rack, 1 Egg Holder
1 Transparent Shelf, 1 Bottle Shelf

FRIDGE

Safety Glass Shelves
1 Glass Shelf over Crisper, 1 Crisper
Automatic Defrosting
Humidity Controller

OPTIONAL FEATURES

Electronic Head Panel Display
Turbo Fan Air Cooling
LED Lighting
Wine Shelf
Adjustable Door Rack
MaxiFresh Preserver

A++

A+

BGN 2750

BUILT-IN COMBI

Niche 1780mm, Sliding door
Door on Door, Reversible doors

FREEZER

4 star freezer, 1 Ice Box
4 Freezer Compartments

TECHNICAL DATA

Energy Class: A+
Gross/Net Volume: 245lt/235lt
Net Fridge/Freezer Volume: 146lt/89lt
Product Dimensions (HxWxD): 1770x540x545

INDOOR FEATURES

1 Dairy Rack, 1 Egg Holder
1 Transparent Shelf, 1 Bottle Shelf

FRIDGE

Safety Glass Shelves
1 Glass Shelf over Crisper, 1 Crisper
Humidity Controller

OPTIONAL FEATURES

Wine Shelf
Adjustable Door Rack
MaxiFresh Preserver



A++

A+

A⁺

A

BGN 3200

BUILT-IN FROST FREE COMBI

Niche 1780 mm
Sliding Door
Door on Door also available BGN3200 D

FRIDGE

3 Removable Shelves
Spill Proof Safety Glass Shelves 1 Glass Shelf over Crisper
2 Crispers

TECHNICAL DATA

Energy Class: A+ / A
Gross / Net Volume: 276 lt / 264 lt
Net Fridge / Freezer Volume: 189 lt / 75 lt
Product Dimensions (HxWxD):
1770 x 540 x 545 mm

INDOOR FEATURES

1 Dairy Rack with Transparent Cover
1 Egg Holder
2 Transparent Shelves
1 Bottle Shelves

FREEZER

**** Freezer
3 Freezer Compartment
1 Ice Box
Manual Defrost

BGN 2610

BUILT-IN DOUBLE DOOR

Niche 1450 mm
Sliding Door
Door on Door : BGN2610
DOD Reversible Doors

FRIDGE

3 Removable Shelves
Safety Glass Shelves
1 Glass Shelf over Crisper
2 Crispers

TECHNICAL DATA

Energy Class: A++ / A+
Gross / Net Volume: 217 lt / 214 lt
Net Fridge / Freezer Volume: 176 lt / 38 lt
Product Dimensions (HxWxD):
1445 x 540 x 545 mm

INDOOR FEATURES

1 Dairy Rack
1 Egg Holder
2 Transparent Shelves
1 Bottle Shelf

FREEZER

**** Freezer
3 Freezer compartments
1 Ice Box

A⁺⁺A⁺

BGN 2400



BUILT-IN SINGLE DOOR

Niche 1230 mm
Sliding Door
Door on Door: BGN2400
DOD Reversible Door

FRIDGE

**** Freezer Compartment
Freezer Door Indicator
1 Ice Box
3 Removable Shelves
Safety Glass Shelves
1 Glass Shelf over Crisper
2 Crispers

TECHINCAL DATA

Energy Class: A++ / A+ / A
Gross / Net Volume: 195 lt / 192 lt
Net Fridge / Freezer Volume: 175 lt/17 lt
Product Dimensions (HxWxD):
1225x540x545 mm

INDOOR FEATURES

1 Dairy Rack
1 Egg Holder
2 Transparent Shelves
1 Bottle Shelf

A++

A+

BGN 2500

BUILT-IN SINGLE DOOR

Niche 1230 mm
Sliding Door
Door on Door: BGN2500
DOD Reversible Door

FRIDGE

4 Removable Shelves
Safety Glass Shelves
1 Glass Shelf over Crisper
2 Crispers

TECHNICAL DATA

Energy Class: A++ / A+ / A
Gross / Net Volume: 206 lt / 204 lt
Product Dimensions (HxWxD):
1225 x 540 x 545 mm

INDOOR FEATURES

1 Dairy Rack
1 Egg Holder
2 Transparent Shelves
1 Bottle Shelf



A++

A+

BGN 1800



BUILT-IN SINGLE DOOR

Niche 1030 mm
Sliding Door
Door on Door: BGN1800
DOD Reversible Door

FRIDGE

**** Freezer Compartment
Freezer Door Indicator
1 Ice Box
2 Removable Shelves
Safety Glass Shelves
1 Glass Shelf over Crisper
2 Crispers

TECHINCAL DATA

Energy Class: A++ / A+ / A
Gross / Net Volume: 153 lt / 150 lt
Net Fridge / Freezer Volume: 133 lt/17 lt
Product Dimensions (HxWxD):
1020 x 540 x 545 mm

FREEZER

1 Dairy Rack
1 Egg Holder
2 Transparent Shelves
1 Bottle Shelf

A++

A+

BGN 1900

BUILT-IN SINGLE DOOR

Niche 1030 mm
Sliding Door
Door on Door: BGN1900
DOD Reversible Door

FRIDGE

3 Removable Shelves
Safety Glass Shelves
1 Glass Shelf over Crisper
2 Crispers

TECHNICAL DATA

Energy Class: A++ / A+ / A
Gross / Net Volume: 162 lt / 160 lt
Product Dimensions (HxWxD):
1020 x 540 x 545 mm

INDOOR FEATURES

1 Dairy Rack
1 Egg Holder
2 Transparent Shelves
1 Bottle Shelf



A++

A+



BGN 1400

BUILT-IN SINGLE DOOR

Niche 880 mm
Sliding Door
Door on Door: BGN1400
DOD Reversible Door

FRIDGE

**** Freezer Compartment
Freezer Door Indicator
1 Ice Box
2 Removable Shelves
Safety Glass Shelves
1 Glass Shelf over Crisper
2 Crispers

TECHINCAL DATA

Energy Class: A++ / A+ / A Gross / Net
Volume: 126 lt / 123 lt Net Fridge /
Freezer Volume:
106 lt / 17 lt
Product Dimensions (HxWxD):
875 x 540 x 545 mm

INDOOR FEATURES

1 Dairy Rack
1 Egg Holder
1 Transparent Shelf
1 Bottle Shelf



BGN 1500

BUILT-IN SINGLE DOOR

Niche 880 mm
Sliding Door
Door on Door: BGN1500
DOD Reversible Door

FRIDGE

3 Removable Shelves
Safety Glass Shelves
1 Glass Shelf over Crisper
2 Crispers

TECHINCAL DATA

Energy Class: A++ / A+ / A
Gross / Net Volume: 137 lt / 136 lt
Product Dimensions (HxWxD):
875 x 540 x 545 mm

INDOOR FEATURES

1 Dairy Rack
1 Egg Holder
1 Transparent Shelves
1 Bottle Shelf



BGN 1450

BUILT-IN SINGLE DOOR

Niche 880 mm
Sliding Door
Door on Door: BGN1450
DOD Reversible Door

FRIDGE

**** Freezer
4 Freezer Compartments
1 Ice Box
Manual Defrost
Control Panel

TECHINCAL DATA

Energy Class: A++ / A+ / A Gross / Net
Volume: 109 lt / 99 lt
Product Dimensions (HxWxD):
875 x 540 x 545 mm
Quick Freeze
Mains On
Temperature Rise Warning





BGN 1600 DOD

BUILT-IN SINGLE DOOR

Niche 820 mm
Door On Door
Reversible Door

FRIDGE

1 Removable Shelf
1 Glass Shelf over Crisper
1 Crisper
Safety Glass Shelves

TECHINCAL DATA

Energy Class: A+
Gross / Net Volume: 120 lt / 115 lt
Product Dimensions (HxWxD):
818 x 595 x 548 mm

INDOOR FEATURES

1 Transparent Shelf
1 Egg Holder
1 Bottle Shelf

A⁺

BGN 1700 DOD

BUILT-IN SINGLE DOOR

Niche 820 mm
Door On Door
Reversible Door

FRIDGE

2 Removable Shelves
1 Glass Shelf over Crisper
1 Crisper
Spill Proof Safety Glass Shelves

TECHINCAL DATA

Energy Class: A+ / A
Gross / Net Volume: 136 lt / 133 lt
Product Dimensions (HxWxD):
818 x 595 x 548 mm

INDOOR FEATURES

1 Transparent Shelf
1 Egg Holder
1 Bottle Shelf



A⁺⁺

A⁺



BGN 1650 DOD

BUILT-IN SINGLE DOOR

Niche 820 mm
Door On Door
Reversible Door

TECHINCAL DATA

Energy Class: A+ / A
Gross / Net Volume: 107 lt / 95 lt
Product Dimensions (HxWxD):
818 x 595 x 548 mm

FRIDGE

**** Freezer
3 Freezer Compartments
1 Ice Box
Manual Defrost
Control Panel
Quick Freeze
Mains On
Temperature Rise Warning

A⁺

A

INSTALLATIONS

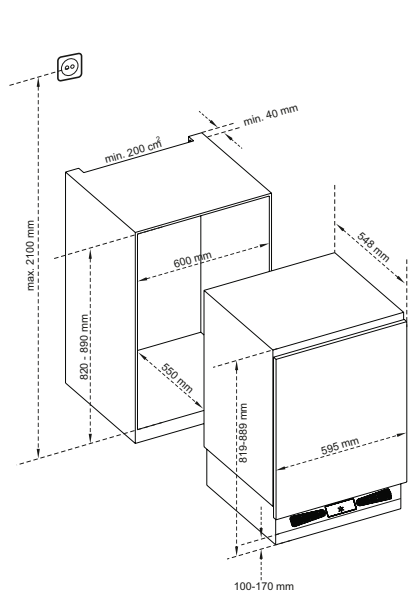

1600 / 1650 / 1700

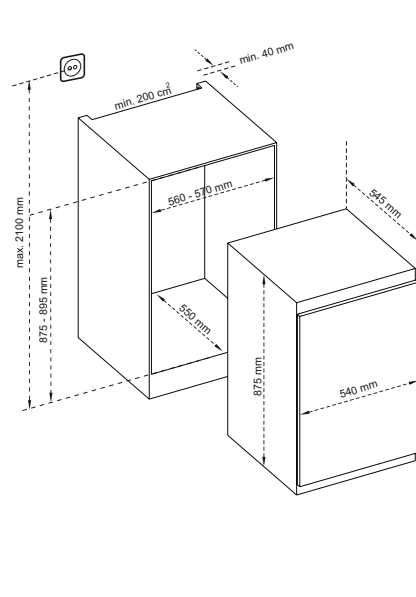

1400 / 1450 / 1500

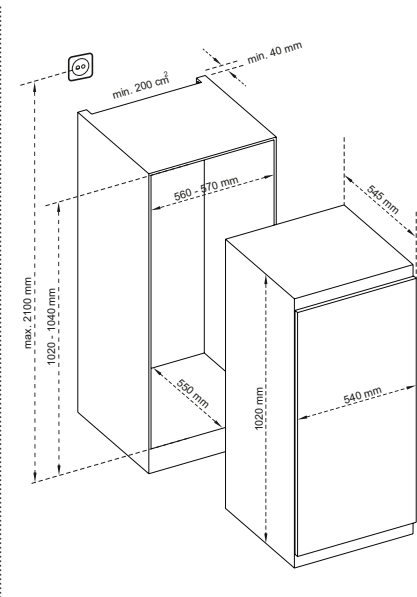

1800 / 1900

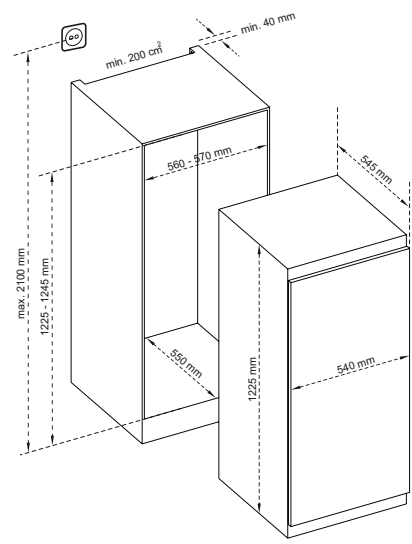

2400 / 2500

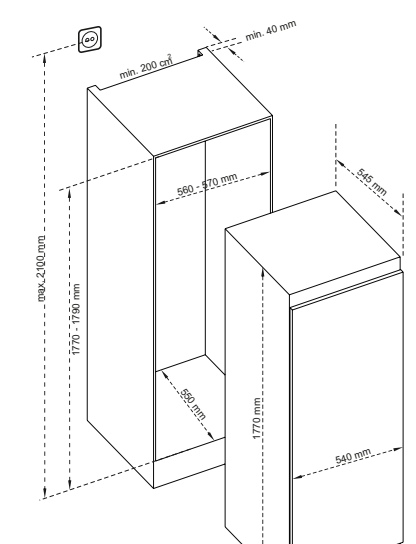

2791 / 2795

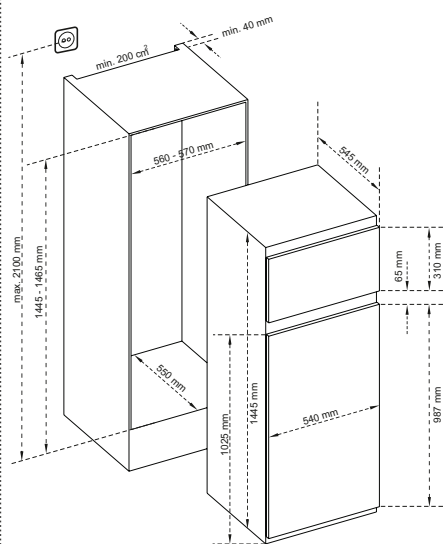

2610

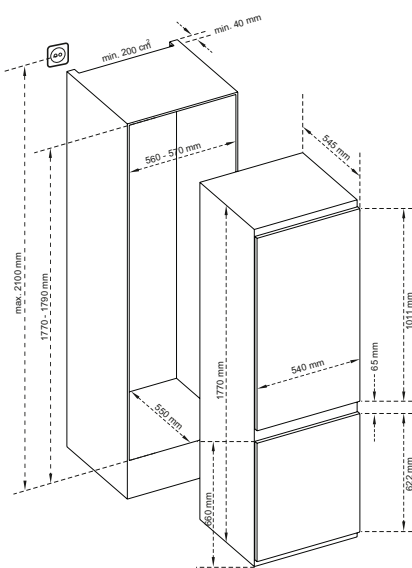

3200

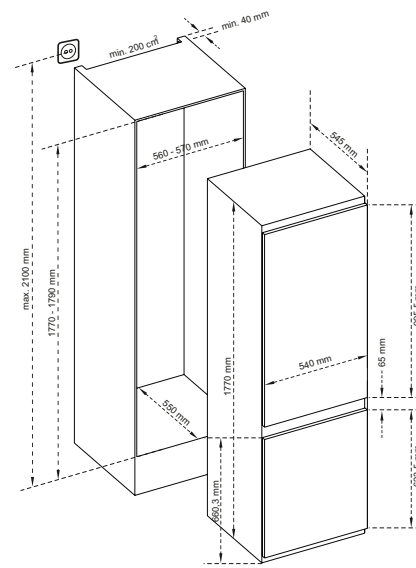

2760 / 2761

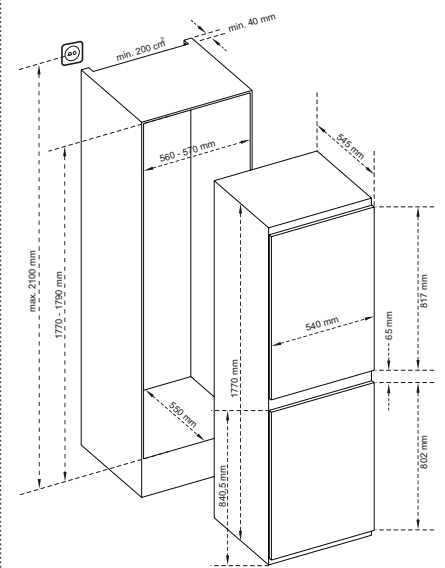

2750 / 2751

60 cm Dishwashers





A+++ -20% A++/A+++AA/A+++AA Class

“Top class ratings for “energy consumption”, “cleaning & drying performance”. The minimum energy class is A++ and the cleaning & drying performance is A for entire model range.



EXTRA DRYING

It is possible to have better drying performance with extra drying option. This option increases water temperature at final rinse step and drying step duration up to 10 min.



EXTRA SILENT

It is possible to have more silent washing with variable speed motor technology! Extra silent option decreases noise level of program without decreasing cleaning quality in day or night time when silence is required.



AUTO PROGRAMS WITH TURBIDITY SENSOR

Turbidity sensor detects the amount of turbidity in water and adjusts the washing cycle parameters (temperature, duration, amount of water) accordingly.



EXTRA FAST

Extra fast option decreases program duration while it is increasing water temperature and pressure to ensure high washing quality in a shorter duration.



EXTRA HYGIENE

Extra hygiene option which is developed for Vestel Dishwashers ensures a maximum hygiene with high temperature washing. It increases water temperature at final rinse step in order to eliminate bacteria up to %99.9999.

**EXTRA RINSE**

Extra rinse option adds an extra rinse step to achieve more hygienic washing. Program duration is increased between min. %4 and max. %16 according to the washing program.

**ANTIBACTERIAL FILTER**

By using Antibacterial PP Sump Filter bacterial growth on the filter surface eliminated up to 99%.

**SUPER 50'**

VESTEL dishwashers achieves A class cleaning performance with advanced cleaning program in only 50 min without diverter. You can save time with this program. It is the first and unique dishwasher that achieves A class cleaning performance in only 50 minutes for standart soiled dishes according to EN standards.

**BLDC PUMP TECHNOLOGY**

This technology enables all other options and program to save water, energy and time. Also by changing water pressure noise level can be reduced to have more silent washing.

**DELAY TIMER**

The start time of a program can be delayed, e.g. to benefit from economy rates of electricity. A delay start time of between 1 hour and 24 hours can be selected.

**TABLET/ALL IN 1 OPTION**

Tablet detergents and combined detergent that contains salt, rinse aid and extra functions are compact and easy to use. But they may have some drawbacks or undissolved tablet residues which are left in the machine. With this option, water reaches optimum temperature to dissolve the combined detergent ideally and eliminates such drawbacks and assures maximum performance when tablet detergents are used.



HALF LOAD- 1/2 OPTION

Eco Friendly Ecowash technology provides washing performance when dishwasher is not fully loaded, only lower basket or upper basket or both are used with half load if necessary by using half load option. Ecowash technology saves energy and water by reducing energy and water consumption due to load options.



VARIOSPACE

VarioSpace is a general feature that gives many options to the end user regarding lower and upper basket variations.



JET WASH

With this fast program, you can clean the dishes like less and/or recently soiled (coffee, milk and tea etc.) in only 18 minutes. This program is one of the fastest programs in the world. It cleans your dishes with 4 place settings capacity in 18 minutes. With this option, water reaches optimum temperature to dissolve the combined detergent ideally and eliminates such drawbacks and assures maximum performance.



DUALPRO WASH

Advanced pump technology allows for one wash to be cleaned at two separate water pressures. Baked on food doesn't stand a chance in the bottom while the delicate glasses in the top are gently being washed.

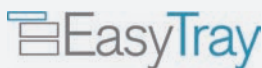

EASY TRAY

The upper cutlery basket is designed to place forks, spoons and knives, long dippers and small items. It is possible to take out the dishes along with the 3rd rack after washing. The Upper Cutlery Basket is composed of two pieces; You can take out left or right part of the upper cutlery basket to obtain more space for the dishes in the upper basket



CHILD LOCK

Child lock option never allows your children to play with your dishwasher. It allows you to lock the buttons on the control panel to be able to restrict the functionality of buttons.

OVERFLOW AND LEAKAGE PROTECTION

The dishwasher activates overflow mode when there is too much water in the dishwasher and the excess water gets drained. It also detects leaks in the base of the dishwasher, shuts down operation and automatically pumps out water before reaching to floor. The unit can auto reset the overflow mode until the water level in the basement cover reaches a certain level.

HEATER SAFETY PROTECTION

In case of lack of water, with the help of a pressure switch, the resistance is prevented from being in operation. So both the resistance and the machine itself are protected.

**TURBO DRYING SYSTEM**

It activates a fan which draws steam out of the dishwasher cabinet. Air circulation is much more forced, hence results in most efficient drying performance.

**MINI ACTIVE DRYING SYSTEM**

Mini active drying system provides basic drying performance on dishes with its mini fins.

**SUPER ACTIVE DRYING SYSTEM**

A portion of the washtub wall is a heat exchanger which, at the end of the rinsing cycle, promotes condensation of the water inside the tub, and hence drying of the dishes.



AUTO DOOR

Auto Door is a technology that makes the drying process more efficient. Auto Door opens the door of the dishwasher during the drying process automatically and by this way the hot air goes out of the dishwasher by itself and so the energy needed to dry the dishes is reduced significantly.

A+++ -20% energy consumption for 14 P.S. is achieved with the help of this technology.



WATER BOX

The working principle of Water Box Technology is based on getting the last clean cycle rinse water, filtering it to avoid any particles and saving it in an isolated box. Then it can be used as the prewash cycle cleaning water next for the cycle. 5,4 lt water consumption with A++ energy rating for 15 P.S. is achieved with the help of this technology.



INFO LED

InfoLED provides information to the user about the current status of dishwasher during washing.

If the light is on, it notifies that dishwasher continues to operate or the notification light turns off when program finishes.



ION TECH

Natural Ion Tech spreads negative ions inside the dishwasher. These negative ions neutralize particles of unpleasant smell. Natural Ion Tech removes odors caused by dirty dishes.



DIRECT WASH

Direct wash spray system is used for washing baby bottles and glasses more effective.



TRIPLE WASH

Triple wash feature offers wide washing option to user. User can wash hard soiled pans and cookers more effective with triple wash sprays.



STEAM WASH

Steam Wash technology softens the most stubborn dirt by steam power. High temperature and directly applied steam ensure perfect hygiene and gentle cleaning for your sensitive dishes.

FEATURES

Upper Basket

MESH TYPE



PEG TYPE



UPPER BASKET OPTIONS

FOLDABLE WIRE



ADJUSTABLE MUG SHELVES



SPOON RACK & GLASS SUPPORT

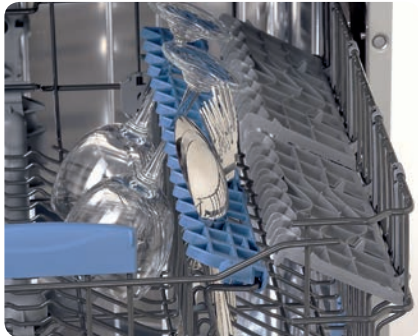

ADJUSTABLE UPPER BASKET WITH LOAD



ADJUSTABLE UPPER BASKET WITHOUT LOAD



PLASTIC HANDLE



WIRE HANDLE

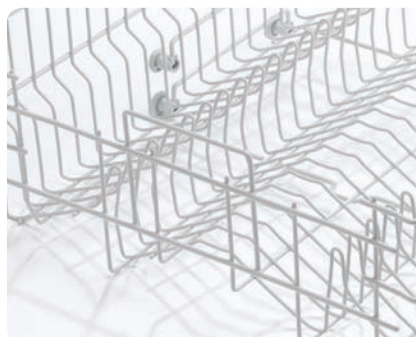

HANDLE WITH CUSTOMIZED LOGO



* For 15 place settings and only for upper basket

Lower Basket

12 PLACE SETTINGS



15 PLACE SETTINGS



12 PLACE SETTINGS (FOR SLIDING CUTLERY BASKET)



* 13 PS will be available on May 2017 as option.



LOWER BASKET OPTIONS

FOLDABLE WIRE (2 OR 4)



MULTI-FUNCTIONAL KIT FOR LOWER BASKET



BOTTLE HOLDER



PLASTIC HANDLE



WIRE HANDLE



UNIVERSAL CUTLERY BASKET



STANDARD CUTLERY BASKET



MODULAR CUTLERY BASKET



SLIDING CUTLERY BASKET



WINE GLASS HOLDER

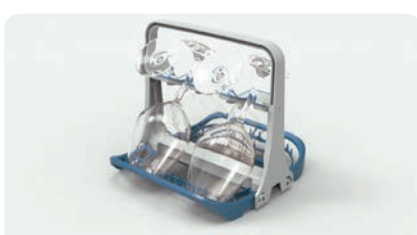

MUG SHELF SUPPORT



3rd Rack

UPPER CUTLERY BASKET

The upper cutlery basket is designed to place forks, spoons and knives, long dippers and small items. You can take out the dishes along with the 3rd rack washing.



VarioSpace
EasyTray

The Upper Cutlery Basket is composed of two pieces; you can take out the left or right part of the upper cutlery basket to obtain more space for the dishes



Extras

TOP NOZZLE

(OPTIONAL FOR 12 P.S.)



IMPELLER

(OPTIONAL FOR 15 P.S.)



AQUA STOP



PLASTIC FILTER

(OPTIONAL)



STAINLESS STEEL

FILTER (DEFAULT)



ANTIBACTERIAL FILTER

(OPTIONAL)



INTERIOR LED LIGHTING

(WHITE)



Pop-in-Pop-out-Knob for Semi Integrated Dishwasher



FEATURES

ADJUSTABLE REAR FOOT FROM THE FRONT



FRONT DECOR FIXATIONS DIFFERENT WEIGHTS



ADJUSTABLE PLINTH



0-100 mm dept adjustment
820-870 mm machine
height adjustment with
high feet

The machine can be
elevated by 50 mm
(820 → 870-920 mm with
high feet)

HIGH FEET



PLATE DIMENSION FOR 12 P.S.



PLATE DIMENSION FOR 15 P.S.



SEMI-INTEGRATED



FULLY-INTEGRATED



T3X (LED) Series



T31, T32: Big LED display (remaining time, delay timer), 6-8 programs, rinse-aid & salt indicators, child lock option, washing cycle indicators, half load option (with three modes: lower basket / upper basket / half load on both baskets), delay timer (1-2-3-...-24hr), 3in1 tablet detergent option, extra hygiene option, extra dry option

T34: Big LED display (remaining time, delay timer), 8 programs, rinse-aid & salt indicators, child lock option, washing cycle indicators, half load option (with three modes: lower basket / upper basket / half load on both baskets), delay timer (1-2-3-...-24hr), 3in1 tablet detergent option, energy save option, extra silent option, extra fast option

T35: Big LED display (remaining time, delay timer), 8 programs, rinse-aid & salt indicators, child lock option, washing cycle indicators, half load option (with three modes: lower basket / upper basket / half load on both baskets), delay timer (1-2-3-...-24hr), 3in1 tablet detergent option, energy save option, extra silent option, extra fast optionsystem.

T Series



T11: 3 programs, rinse-aid & salt indicators, child lock option, washing cycle indicators, half load option (with one mode)



T12: 4 programs, rinse-aid & salt indicators, child lock option, washing cycle indicators, half load option (with one mode), display (remaining time, delay timer), delay timer (1-2-3-...-24hr)



T13: 6 programs, rinse-aid & salt indicators, child lock option, washing cycle indicators, half load option (with one mode), display (remaining time, delay timer), delay timer (1-2-3-...-24hr), 3in1 tablet detergent option, extra hygiene option



T21: 8 programs, rinse-aid & salt indicators, child lock option, washing cycle indicators, half load option (with three modes: lower basket / upper basket / half load on both baskets), display (remaining time, delay timer), delay timer (1-2-3-...-24hr), 3in1 tablet detergent option, extra dry option, extra rinse option, extra hygiene option. detergent option

T24: 8 programs, rinse-aid & salt indicators, child lock option, washing cycle indicators, half load option (with three modes: lower basket / upper basket / half load on both baskets), display (remaining time, delay timer), delay timer (1-2-3-...-24hr), 3in1 tablet detergent option, extra silent option, extra fast option, energy save option.

T25: 8 programs, rinse-aid & salt indicators, child lock option, washing cycle indicators, half load option (with three modes: lower basket / upper basket / half load on both baskets), display (remaining time, delay timer), delay timer (1-2-3-...-24hr), 3in1 tablet detergent option, extra silent option, extra fast option, energy save option. option, energy save button

Programs

SEMI-INTEGRATED T3X (LED) 60cm Models	T31	T32	T34	T35
Prewash	Yes	Yes	-	-
Eco 50°C	Yes	Yes	Yes	Yes
Jet Wash 18'	Yes	Yes	Yes	Yes
Quick 30' 40°C	Yes	Yes	Yes	Yes
Super 50' 65°C	Yes	Yes	Yes	Yes
Dual Pro Wash 60°C	-	-	Yes	Yes
Hygiene 70°C	-	-	Yes	Yes
Auto Delicate 30°C - 50°C	-	Yes	Yes	Yes
Auto Normal 50°C - 60°C	-	Yes	-	-
Auto Intensive 60°C - 70°C	Yes	Yes	Yes (50°C - 70°C)	Yes (50°C - 70°C)

SEMI-INTEGRATED T SERIES 60cm Models	T11	T12	T13	T21	T24	T25
Prewash	-	-	Yes	Yes	-	-
Jet Wash 18'	-	-	-	-	Yes	Yes
Eco 50°C	Yes	Yes	Yes	Yes	Yes	Yes
Intensive 65°C	Yes	Yes	Yes	-	-	-
Quick 30' 40°C	-	Yes	Yes	Yes	Yes	Yes
Super 50' 65 °C	Yes	Yes	Yes	Yes	Yes	Yes
Delicate 40°C	-	-	Yes	-	-	-
Daily 60°C	-	-	-	Yes	-	-
Auto Delicate 30°C - 50°C	-	-	-	Yes	Yes	Yes
Auto Normal 50°C - 60°C	-	-	-	Yes	-	-
Auto Intensive 60°C - 70°C	-	-	-	Yes	Yes (50°C-70°C)	Yes (50°C-70°C)
Hygiene 70°C	-	-	-	-	Yes	Yes
Dual Pro Wash 60°C	-	-	-	-	Yes	Yes

Y Series



Y24:
9 programs, rinse-aid & salt indicators, child lock option, washing cycle indicators, half load option (with three modes: lower basket / upper basket / half load on both baskets), display (remaining time, delay timer), delay timer (1-2-3-...-19hr), 3in1 tablet detergent option, extra hygiene option, extra dry option, extra rinse option

Y23:
8 programs, rinse-aid & salt indicators, child lock option, washing cycle indicators, half load option (with three modes: lower basket / upper basket / half load on both baskets), display (remaining time, delay timer), delay timer (1-2-3-...-19hr), 3in1 tablet detergent option, extra hygiene option, extra dry option, extra rinse option

Y22:
7 programs, rinse-aid & salt indicators, child lock option, washing cycle indicators, half load option (with three modes: lower basket / upper basket / half load on both baskets), display (remaining time, delay timer), delay timer (1-2-3-...-19hr), 3in1 tablet detergent option, extra hygiene option, extra dry option, extra rinse option

Y21:
6 programs, rinse-aid & salt indicators, child lock option, washing cycle indicators, half load option (with three modes: lower basket / upper basket / half load on both baskets), display (remaining time, delay timer), delay timer (1-2-3-...-19hr), 3in1 tablet detergent option, extra hygiene option, extra dry option, extra rinse option



Y15:
6 programs, rinse-aid & salt indicators, washing cycle indicators, half load option (with one mode), delay timer (3-6-9hr)

Y14:
5 programs, rinse-aid & salt indicators, washing cycle indicators, half load option (with one mode), delay timer (3-6-9hr)

Y13:
4 programs, rinse-aid & salt indicators, washing cycle indicators, half load option (with one mode), delay timer (3-6-9hr)

Y12:
3 programs, rinse-aid & salt indicators, washing cycle indicators, half load option (with one mode), delay timer (3-6-9hr)

Y11:
2 programs, rinse-aid & salt indicators, washing cycle indicators, half load option (with one mode), delay timer (3-6-9hr)



Extra features with display (Y1A & Y1F):

Child lock option, display (remaining time, delay timer), delay timer (1-2-3-...-19hr), 3in1 tablet detergent option, extra hygiene option, extra dry option, extra rinse option

Programs

SEMI-INTEGRATED Y SERIES 60cm Models*	Y11 - Y1A	Y12 - Y1B	Y13 - Y1C	Y14 - Y1D	Y15 - Y1E	Y1F	Y21	Y22	Y23	Y24
Prewash	-	-	-	-	Yes	Yes	Yes	Yes	Yes	Yes
Eco	Yes	Yes	Yes	Yes	Yes	Yes	Yes	Yes	Yes	Yes
Intensive 65°C	Yes	Yes	Yes	Yes	Yes	Yes	Yes	Yes	Yes	Yes
Quick 30' 40°C	-	-	Yes	Yes	Yes	Yes	Yes	Yes	Yes	Yes
Super 50' 65°C	-	Yes	Yes	Yes	Yes	Yes	Yes	Yes	Yes	Yes
Super 55' 60°C	-	-	-	-	-	-	-	-	-	-
Delicate 40°C	-	-	-	-	-	Yes	Yes	Yes	Yes	-
Normal 55°C	-	-	-	-	-	-	-	Yes	Yes	-
Auto Delicate 30°C - 50°C	-	-	-	-	-	-	-	-	-	Yes
Auto Normal 50°C - 60°C	-	-	-	-	-	-	-	-	-	Yes
Auto Intensive 60°C - 70°C	-	-	-	-	-	-	-	-	-	Yes
Hygiene 70°C	-	-	-	Yes	Yes	Yes	-	-	Yes	Yes

*: Y1A-F: with display versions

X&C Series



C41:
9 programs, rinse-aid & salt indicators, child lock option, washing cycle indicators, half load option (with three modes: lower basket / upper basket / half load on both baskets), display (remaining time, delay timer), delay timer (1-2-3-...-19hr), prewash button



C31:
7 programs, rinse-aid & salt indicators, child lock option, washing cycle indicators, half load option (with three modes: lower basket / upper basket / half load on both baskets), delay timer (3-6-9-12hr), prewash button



C21:
6 programs, rinse-aid & salt indicators, child lock option, washing cycle indicators, delay timer (3-6-9-12hr), prewash button



X16:
7 programs, rinse-aid & salt indicators, washing cycle indicators, half load option (with one mode), delay timer (3-6-9hr)

X15:
6 programs, rinse-aid & salt indicators, washing cycle indicators, half load option (with one mode), delay timer (3-6-9hr)

X14, X13, X12, X11:
5, 4, 3, 2 programs, rinse-aid & salt indicators, washing cycle indicators, half load option (with one mode), delay timer (3-6-9hr)



Extra features with display (X1A-F):

Child lock option, display (remaining time, delay timer), delay timer (1-2-3-...-19hr)

Programs

SEMI-INTEGRATED X&C SERIES 60cm Models**	X11 - X1A	X12 - X1B	X13 - X1C	X14 - X1D	X15 - X1E	X16 - X1F	C21	C31	C41
Prewash	-	-	-	-	Yes	Yes	Yes*	Yes*	Yes*
Eco 50°C	Yes	Yes	Yes	Yes	Yes	Yes	Yes	Yes	Yes
Intensive 65°C	Yes	Yes	Yes	Yes	Yes	Yes	Yes	Yes	-
Quick 30' 40°C	-	-	Yes	Yes	Yes	Yes	Yes	Yes	Yes
Super 50' 65°C	-	Yes	Yes	Yes	Yes	Yes	Yes	Yes	-
Super 55' 60°C	-	-	-	-	-	-	-	-	Yes
Delicate 40°C	-	-	-	-	-	Yes	-	Yes	-
Auto Delicate 30°C - 50°C	-	-	-	-	-	-	-	-	Yes
Auto Normal 50°C - 60°C	-	-	-	-	-	-	-	-	Yes
Auto Intensive 60°C - 70°C	-	-	-	-	-	-	-	-	Yes
Hygiene 60°C	-	-	-	-	-	-	-	-	Yes
Hygiene 70°C	-	-	-	Yes	Yes	Yes	-	-	-
Extra Intensive 70°C (Prewash Button + Intensive 65°C)	-	-	-	-	-	-	Yes	Yes	-
Extra Hygiene 70°C (Prewash Button + Hygiene 60°C)	-	-	-	-	-	-	-	-	Yes

*: Seperate function button

** : X1A-F: with display versions

FULLY-INTEGRATED: CONTROL PANELS

D Series



D53: 8+ programs, touch panel, rinse-aid & salt indicators, audible signal (buzzer at the end programme), half load option (with three modes: lower basket / upper basket / half load on both baskets), display (remaining time, delay timer), delay timer (1-2-3-...-19hr), 3in1 tablet detergent option, extra silent option, extra fast option, energy save option, InfoLED (optional)



D52: 8+ programs, touch panel, rinse-aid & salt indicators, audible signal (buzzer at the end programme), half load option (with three modes: lower basket / upper basket / half load on both baskets), display (remaining time, delay timer), delay timer (1-2-3-...-19hr), 3in1 tablet detergent option, extra rinse option, InfoLED (optional)



D51: 6 programs, touch panel, rinse-aid & salt indicators, audible signal (buzzer at the end programme), half load option (with one mode), display (remaining time, delay timer), delay timer (1-2-3-...-19hr), 3in1 tablet detergent option, InfoLED (optional)



D41: 9+ programs, rinse-aid & salt indicators, end of cycle indicator, audible signal (buzzer at the end programme), half load option (with three modes: lower basket / upper basket / half load on both baskets), display (remaining time, delay timer), delay timer (1-2-3-...-19hr), 3in1 tablet detergent option, prewash button

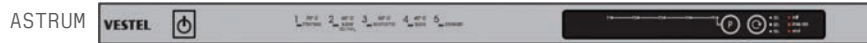
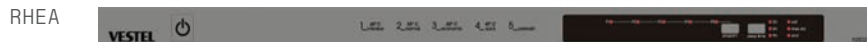

D21: 5 programs, rinse-aid & salt indicators, end of cycle indicator, audible signal (buzzer at the end programme), delay timer (3-6-9hr)



D13: 4 programs, rinse-aid & salt indicators, end of cycle indicator, audible signal (buzzer at the end programme)

Programs

FULLY-INTEGRATED 60cm Models	D13	D21	D41	D51	D52	D53
Prewash	Yes	Yes	Yes	-	-	-
Mini 18'	-	-	-	Yes	Yes	Yes
Eco 50°C	Yes	Yes	Yes	Yes	Yes	Yes
Intensive 65°C	Yes	-	-	Yes	-	-
Intensive 70°C	-	Yes	-	-	-	-
Quick 30' 40°C	-	Yes	Yes	Yes	Yes	Yes
Super 50' 65°C	Yes	Yes	-	Yes	Yes	Yes
Super 55' 60°C	-	-	Yes	-	-	-
Auto Delicate 30°C - 50°C	-	-	Yes	-	Yes	Yes
Auto Normal 50°C - 60°C	-	-	Yes	-	Yes	-
Auto Intensive 60°C - 70°C	-	-	Yes	-	Yes	Yes (50°C-70°C)
Hygiene 60°C	-	-	Yes	Yes	Yes	Yes
Extra Hygiene 70°C (Prewash Button + Hygiene 60°C)	-	-	Yes	-	-	-

Semi-Integrated Panel Color Options

WHITE



BLACK



INOX



ALUMINIUM LOOK



DARK SILVER



WHITE



BLACK

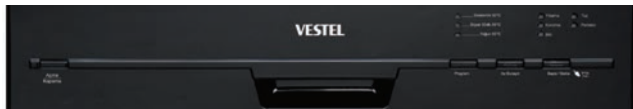

WHITE



BLACK



DARK SILVER



Fully-Integrated Panel Color Options

WHITE



BLACK

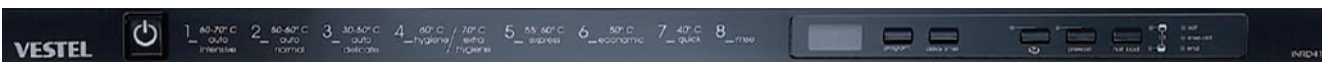

DARK SILVER



For each aesthetics, please ask for different color options.



T35 Ares

STANDARD FEATURES

- 14 place settings
- 8 programs, 6+ temperatures
- Rinse aid & salt indicators
- Washing cycle indicators
- Child lock option
- Overflow and leakage protection
- Heater protection
- Half load option (with three modes)
(lower basket/upper basket /half load on both baskets)
- Display (remaining time, delay timer)
- Delay timer (1-2-3-...-24hr)
- 3in1 tablet detergent option
- Extra silent option
- Extra fast option
- Energy save option
- Auto door technology
- Water box technology
- Overflow and leakage protection
- Heater protection
- 9 lt water consumption

PERFORMANCE

A+++AA -%20, 44 dB(A)*

COLOR OPTIONS

White / Black / Dark Silver

A+++ -20%



* Patara is also available

T34 Ares

STANDARD FEATURES

- 12 / 15 place settings
- 8 programs, 6+ temperatures
- Rinse aid & salt indicators
- Washing cycle indicators
- Child lock option
- Overflow and leakage protection
- Heater protection
- Half load option (with three modes)
(lower basket/upper basket /half load on both baskets)
- Display (remaining time, delay timer)
- Delay timer (1-2-3-...-24hr)
- 3in1 tablet detergent option
- Extra silent option
- Extra fast option
- Energy save option
- Auto door technology
- 9 lt water consumption

PERFORMANCE

A+++AA, 46 dB(A), 12ps*
A+++AA, 44 dB(A), 15ps

COLOR OPTIONS

White / Black / Dark Silver



* Patara is also available

A+++

* 13 PS will be also available as an option on May 2017.

T32 Patara

STANDARD FEATURES

12 / 15 place settings
 8 programs , 6+ temperatures
 Rinse aid & salt indicators
 Washing cycle indicators
 Child lock option
 Overflow and leakage protection
 Heater protection
 Half load option (with three modes)
 (lower basket/upper basket /half load
 on both baskets)
 Display (remaining time, delay timer)
 Delay timer (1-2-3-...-24hr)
 3in1 tablet detergent option
 Extra hygiene option
 Extra dry option
 9 lt water consumption

PERFORMANCE

A++AA, 54/52/49/47/45 dB(A)*

COLOR OPTIONS

White / Black / Dark Silver



* Ares is also available

A++

T31 Patara

STANDARD FEATURES

12 / 15 place settings
 6 programs, 6+ temperatures
 Rinse aid & salt indicators
 Washing cycle indicators
 Child lock option
 Overflow and leakage protection
 Heater protection
 Half load option (with three modes)
 (lower basket/upper basket /half load
 on both baskets)
 Display (remaining time, delay timer)
 Delay timer (1-2-3-...-24hr)
 3in1 tablet detergent option
 Extra hygiene option
 Extra dry option
 9 lt water consumption

PERFORMANCE

A++AA, 54/52/49/47/45 dB(A)*

COLOR OPTIONS

White / Black / Dark Silver



* Ares is also available

A++

* 13 PS will be also available as an option on May 2017.

T25 Amaranth



STANDARD FEATURES

14 place settings
 8 programs, 6+ temperatures
 Rinse aid & salt indicators
 Washing cycle indicators
 Child lock option
 Overflow and leakage protection
 Heater protection
 Half load option (with three modes)
 (lower basket/upper basket /half load on both baskets)
 Display (remaining time, delay timer)
 Delay timer (1-2-3-...-24hr)
 3in1 tablet detergent option
 Extra silent option
 Extra fast option
 Energy save option
 Auto door technology
 Water box technology
 9 lt water consumption
 Structures

PERFORMANCE

A+++AA -%20, 44 dB(A)*

COLOR OPTIONS

White / Black / Dark Silver

A+++ -20%



T24 Amaranth

STANDARD FEATURES

12 / 15 place settings
 8 programs, 6+ temperatures
 Rinse aid & salt indicators
 Washing cycle indicators
 Child lock option
 Overflow and leakage protection
 Heater protection
 Half load option (with three modes)
 (lower basket/upper basket /half load on both baskets)
 Display (remaining time, delay timer)
 Delay timer (1-2-3-...-24hr)
 3in1 tablet detergent option
 Extra silent option
 Extra fast option
 Energy save option
 Auto door technology
 9 lt water consumption

PERFORMANCE

A+++AA, 46 dB(A), 12ps*
 A+++AA, 44 dB(A), 15ps

COLOR OPTIONS

White / Black / Dark Silver



A+++

* 13 PS will be also available as an option on May 2017.

T21 Amaranth

STANDARD FEATURES

12 / 15 place settings
 8 programs , 6+ temperatures
 Rinse aid & salt indicators
 Washing cycle indicators
 Child lock option
 Overflow and leakage protection
 Heater protection
 Half load option (with three modes)
 (lower basket/upper basket /half load
 on both baskets)
 Display (remaining time, delay timer)
 Delay timer (1-2-3-...-24hr)
 3in1 tablet detergent option
 Extra hygiene option
 Extra dry option
 Extra rinse option
 9 lt water consumption

PERFORMANCE

A++AA, 54/52/49/47/45 dB(A)*

COLOR OPTIONS

White / Black / Dark Silver



A⁺⁺

T13 Amaranth

STANDARD FEATURES

12 place settings
 6 programs, 3 temperatures
 Rinse aid & salt indicators
 Washing cycle indicators
 Child lock option
 Overflow and leakage protection
 Heater protection
 Half load option (with one mode)
 Display (remaining time, delay timer)
 Delay timer (1-2-3-...-24hr)
 3in1 tablet detergent option
 Extra hygiene option
 12 lt water consumption

PERFORMANCE

A++AA, 57/54/52/49/47/45 dB(A)*

COLOR OPTIONS

White / Black / Dark Silver



A⁺⁺

* 13 PS will be also available as an option on May 2017.

T12 Amaranth

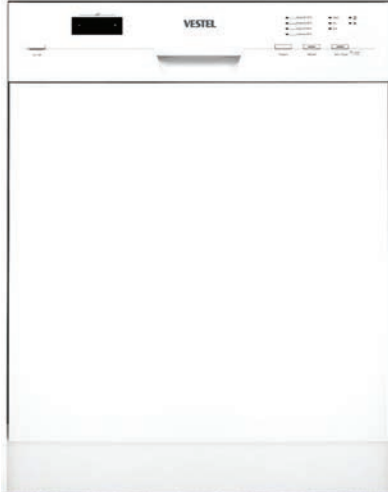

STANDARD FEATURES

- 12 place settings
- 4 programs, 3 temperatures
- Rinse aid & salt indicators
- Washing cycle indicators
- Child lock option
- Overflow and leakage protection
- Heater protection
- Half load option (with one mode)
- Display (remaining time, delay timer)
- Delay timer (1-2-3-...-24hr)
- 12 lt water consumption

PERFORMANCE

A++AA, 57/54/52/49/47/45 dB(A)*

COLOR OPTIONS

White / Black / Dark Silver

A++

T11 Amaranth

STANDARD FEATURES

- 12 place settings
- 3 programs, 2 temperatures
- Rinse aid & salt indicators
- Washing cycle indicators
- Child lock option
- Overflow and leakage protection
- Heater protection
- Half Load Option (with one mode)
- 12 lt water consumption

PERFORMANCE

A++AA, 57/54/52/49/47/45 dB(A)*

COLOR OPTIONS

White / Black / Dark Silver



A++

* 13 PS will be also available as an option on May 2017.

Y24 Silva

STANDARD FEATURES

12 / 15 place settings
 9 programs, 7+ temperatures
 Rinse aid & salt indicators
 Washing cycle indicators
 Child lock option
 Overflow and leakage protection
 Heater protection
 Half load option (with three modes)
 (lower basket/upper basket /half load
 on both baskets)
 Display (delay timer, remaining time)
 Delay timer (1-2-3-...-19hr)
 3in1 tablet detergent option
 Extra hygiene option
 Extra rinse option
 Extra dry option
 9 lt water consumption

PERFORMANCE

A++AA, 54/52/49/47/45 dB(A)*

COLOR OPTIONS

White / Black / Dark Silver



* Camelia is also available

A++

Y23 Camelia

STANDARD FEATURES

12 / 15 place settings
 8 programs, 5 temperatures
 Rinse aid & salt indicators
 Washing cycle indicators
 Child lock option
 Overflow and leakage protection
 Heater protection
 Half load option (with three modes)
 (lower basket/upper basket /half load
 on both baskets)
 Display (delay timer, remaining time)
 Delay timer (1-2-3-...-19hr)
 3in1 tablet detergent option
 Extra hygiene option
 Extra rinse option
 Extra dry option
 9 lt water consumption

PERFORMANCE

A++AA, 54/52/49/47/45 dB(A)*

COLOR OPTIONS

White / Black / Dark Silver

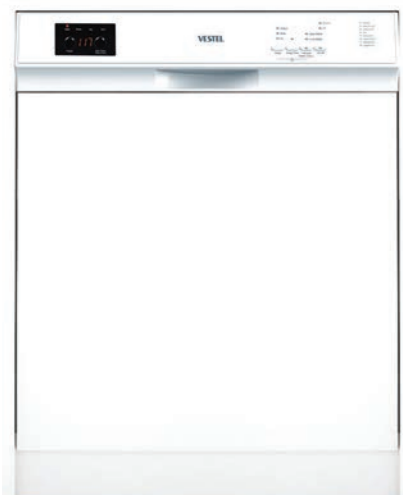

A++

* Silva is also available

* 13 PS will be also available as an option on May 2017.

Y22 Camelia



STANDARD FEATURES

12 / 15 place settings
 7 programs, 4 temperatures
 Rinse aid & salt indicators
 Washing cycle indicators
 Child lock option
 Overflow and leakage protection
 Heater protection
 Half load option (with three modes)
 (lower basket/upper basket /half load
 on both baskets)
 Display (delay timer, remaining time)
 Delay timer (1-2-3-...-19hr)
 3in1 tablet detergent option
 Extra hygiene option
 Extra rinse option
 Extra dry option
 9 lt water consumption

PERFORMANCE

A++AA, 57/54/52/49/47/45 dB(A)*

COLOR OPTIONS

White / Black / Dark Silver

A++

* Silva is also available

Y21 Silva

STANDARD FEATURES

12 / 15 place settings
 6 programs, 3 temperatures
 Rinse aid & salt indicators
 Washing cycle indicators
 Child lock option
 Overflow and leakage protection
 Heater protection
 Half load option (with three modes)
 (lower basket/upper basket /half load
 on both baskets)
 Display (delay timer, remaining time)
 Delay timer (1-2-3-...-19hr)
 3in1 tablet detergent option
 Extra hygiene option
 Extra rinse option
 Extra dry option
 9 lt water consumption

PERFORMANCE

A++AA, 57/54/52/49/47/45 dB(A)*

COLOR OPTIONS

White / Black / Dark Silver



* Camelia is also available

A++

* 13 PS will be also available as an option on May 2017.

Y11-5 & Y1A-F *with display*

STANDARD FEATURES

12 place settings
2 / 3 / 4 / 5 / 6 / 7 programs, 2 / 3 / 4 temperatures
Rinse aid & salt indicators
Washing cycle indicators
Overflow and leakage protection
Heater protection
Half load option (with one mode)
Delay timer (3-6-9hr)
12 lt water consumption

EXTRA FEATURES WITH DISPLAY

Child lock option
Display (remaining time, Delay timer)
Delay timer (1-2-3-...-19hr)
3in1 tablet detergent option
Extra hygiene option
Extra rinse option
Extra dry option

PERFORMANCE

A++AA, 57/54/52/49/47/45 dB(A)*

COLOR OPTIONS

White / Black / Dark Silver

* Silva and Camelia aesthetics available



* 13 PS will be also available as an option on May 2017.

D53 Freya



STANDARD FEATURES

- 15 place settings
- Hidden control panel
- Touch panel
- 8+ programs, 6+ temperatures
- Rinse aid & salt indicators
- Overflow and leakage protection
- Heater protection
- Audible signal (buzzer at the end programme)
- Half load option (with three modes) (lower basket/upper basket /half load on both baskets)
- Display (delay timer, remaining time)
- Delay timer (1-2-3-...-19hr)
- 3in1 tablet detergent button
- Energy save option
- Extra silent option
- Extra fast option
- InfoLED (optional)
- 9 lt water consumption

PERFORMANCE

A++AA, 44 dB(A)

COLOR OPTIONS

Black

A++



D52 Freya

STANDARD FEATURES

- 12 / 15 place settings
- Hidden control panel
- Touch panel
- 8+ programs, 6+ temperatures
- Rinse aid & salt indicators
- Overflow and leakage protection
- Heater protection
- Audible signal (buzzer) at the end program
- Half load option (with three modes) (lower basket/upper basket /half load on both baskets)
- Display (delay timer, remaining time)
- Delay timer (1-2-3-...-19hr)
- 3in1 tablet detergent button
- Extra rinse option
- 9 lt water consumption
- InfoLED (optional)

PERFORMANCE

A++AA, 54/52/49/47/45 dB(A)*

COLOR OPTIONS

Black



A++

* 13 PS will be also available as an option on May 2017.

D51 Freya

STANDARD FEATURES

12 place settings
 Hidden control panel
 Touch panel
 6 programs, 3 temperatures
 Rinse aid & salt indicators
 Overflow and leakage protection
 Heater protection
 Audible signal (buzzer) at the end program
 Half load option (with one mode)
 Display (delay timer, remaining time)
 Delay timer (1-2-3-...-19hr)
 3in1 tablet detergent button
 12 lt water consumption
 InfoLED (optional)

PERFORMANCE

A++AA, 57/54/52/49/47/45 dB(A)*

COLOR OPTIONS

Black



D41 Rhea

STANDARD FEATURES

12 / 15 place settings
 Hidden control panel
 Standard or membrane button
 9+ programs, 6+ temperatures
 Rinse aid & salt indicators
 End of cycle indicator
 Overflow and leakage protection
 Heater protection
 Audible signal (buzzer) at the end of program
 Half load option (with three modes)
 (lower basket/upper basket /half load on both baskets)
 Display (delay timer, remaining time)
 Delay timer (1-2-3-...-19hr)
 3in1 tablet detergent button
 Prewash button
 9 lt water consumption

PERFORMANCE

A++AA, 54/52/49/47/45 dB(A)*

COLOR OPTIONS

White / Black / Dark Silver



* Astrum is also available

* 13 PS will be also available as an option on May 2017.



D21 Rhea

STANDARD FEATURES

- 12 place settings
- Hidden control panel
- Standard or membrane button
- 5 programs, 4 temperatures
- Rinse aid & salt indicators
- End of cycle indicator
- Overflow and leakage protection
- Heater protection
- Audible signal (buzzer) at the end of program
- Delay timer (3-6-9hr)
- 12 lt water consumption

PERFORMANCE

A++AA, 57/54/52/49/47/45 dB(A)*

COLOR OPTIONS

White / Black / Dark Silver

* Astrum is also available

A++



D13 Rhea

STANDARD FEATURES

- 12 place settings
- Hidden control panel
- Standard or membrane button
- 4 programs, 2 temperatures
- Rinse aid & salt indicators
- End of cycle Indicator
- Overflow and leakage protection
- Heater protection
- Audible signal (buzzer) at the end of program
- 12 lt water consumption

PERFORMANCE

A++AA, 57/54/52/49/47/45 dB(A)*

COLOR OPTIONS

White / Black / Dark Silver

* Astrum is also available

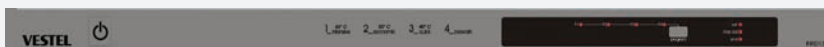

A++

* 13 PS will be also available as an option on May 2017.

C41 Camelia

STANDARD FEATURES

12 / 15 place settings
 9 programs, 6+ temperatures
 Rinse aid & salt indicators
 Washing cycle indicators
 Child lock option
 Overflow and leakage protection
 Heater protection
 Half load option (with three modes)
 (lower basket/upper basket /half load
 on both baskets)
 Display (delay timer, remaining time)
 Delay timer (1-2-3-...-19hr)
 3in1 tablet detergent option
 Prewash button
 9 lt water consumption

PERFORMANCE

A++AA, 54/52/49/47/45 dB(A)*

PANEL ADD ON MATERIAL

White / Black / Aluminium look lexan,
 inox sheet



* Silva is also available

A++

C31 Camelia

STANDARD FEATURES

12 / 13 place settings
 7 programs, 4 temperatures
 Rinse aid & salt indicators
 Washing cycle indicators
 Child lock option
 Overflow and leakage protection
 Heater protection
 Half load option (with three modes)
 (lower basket/upper basket /half load
 on both baskets)
 Delay timer (3-6-9-12hr)
 Prewash button
 9 lt water consumption

PERFORMANCE

A++AA, 54/52/49/47/45 dB(A)*

PANEL ADD ON MATERIAL

White / Black / Aluminium look lexan,
 inox sheet



* Silva is also available

A++

* 13 PS will be also available as an option on May 2017.

C21 Silva

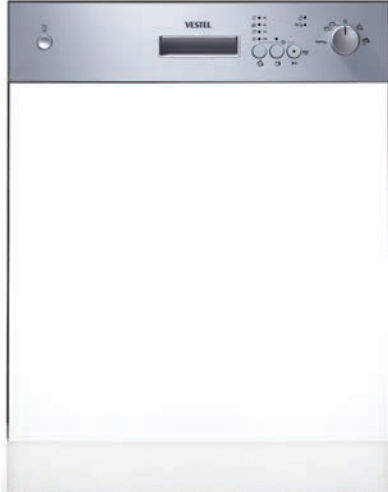

STANDARD FEATURES

- 12 place settings
- 6 programs, 4 temperatures
- Rinse aid & salt indicators
- Washing cycle indicators
- Child lock option
- Overflow and leakage protection
- Heater protection
- Delay timer (3-6-9-12hr)
- Prewash button
- 12 lt water consumption

PERFORMANCE

A++AA, 57/54/52/49/47/45 dB(A)

PANEL ADD ON MATERIAL

White / Black / Aluminium look lexan, inox sheet

A++

* Camelia is also available

X11-6 & X1A-F *with display* Silva

STANDARD FEATURES

- 12 place settings
- 2 / 3 / 4 / 5 / 6 / 7 programs, 3 / 4 temperatures
- Rinse aid & salt indicators
- Washing cycle indicators
- Overflow and leakage protection
- Heater protection
- Half load option (with one mode)
- Delay timer (3-6-9hr)
- 12 lt water consumption

EXTRA FEATURES WITH DISPLAY

- Child lock option
- Display (remaining time, Delay timer)
- Delay timer (1-19hr)

PERFORMANCE

A++AA, 57/54/52/49/47/45 dB(A)

PANEL ADD ON MATERIAL

White / Black / Aluminium look lexan, inox sheet

* Silva and Camelia aesthetics available

* Half-load option and Rinse aid/ Salt indicator must be selected together



A++

SEMI-INTEGRATED

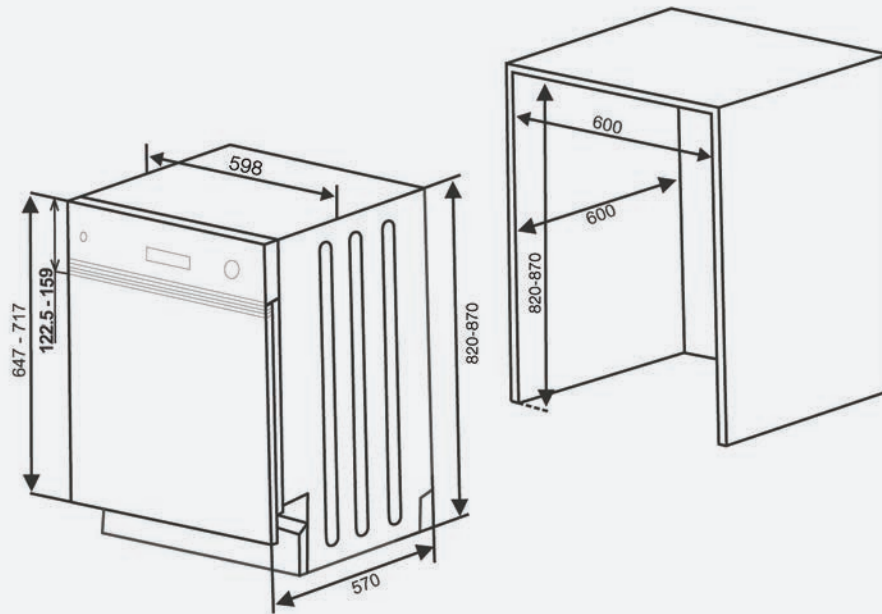

FULLY-INTEGRATED

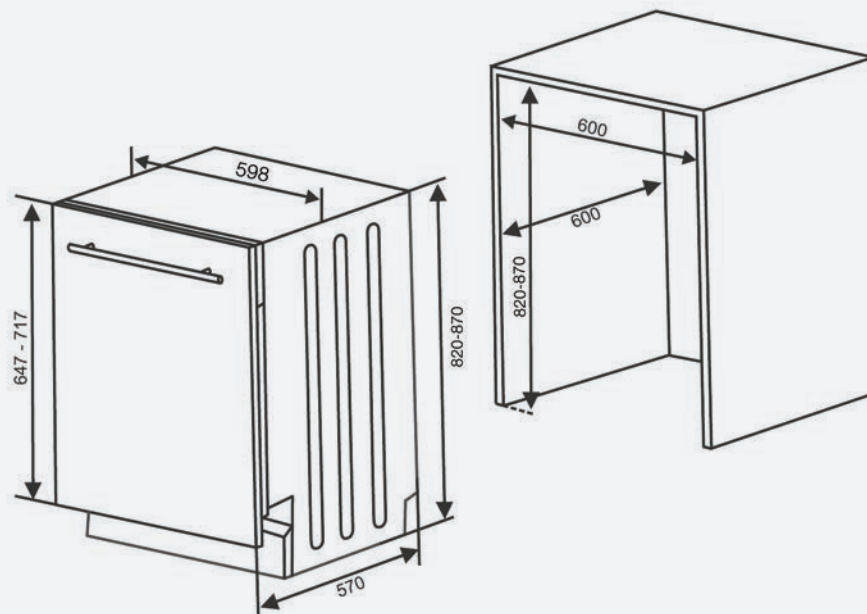

45 cm Dishwashers



A+++AA/ A++AA Class

Top class ratings for “energy consumption”, “cleaning & drying performance”. The minimum energy class is A++ and the cleaning & drying performance is A for entire model range.

MAXIMUM PLATE DIAMETER

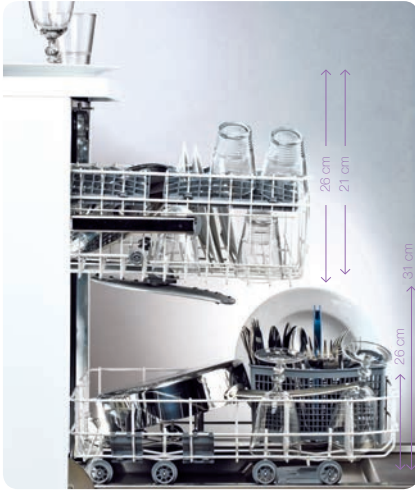

STANDARD CUTLERY BASKET



ADJUSTABLE UPPER BASKET



Adjustable only when empty

LOWER BASKET - 10 PLACE SETTINGS



ADJUSTABLE BASKET

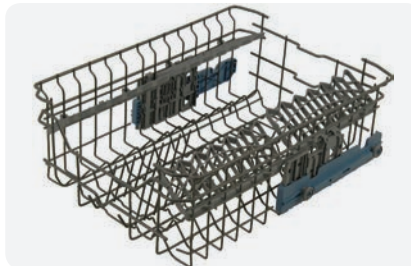

Adjustable only when loaded

SEMI-INTEGRATED SLIM X&T SERIES 45cm Models*	X13 - X1C	X15 - X1E	T14	T15	T21	T22	T24
Prewash	Yes	Yes	Yes	Yes	Yes	Yes	Yes
Eco 50°C	Yes	Yes	Yes	Yes	Yes	Yes	Yes
Intensive 65°C	Yes	Yes	Yes	Yes	-	-	-
Quick 30' 40°C	-	Yes	Yes	Yes	Yes	Yes	Yes
Super 50' 65°C	Yes	Yes	Yes	Yes	Yes	Yes	Yes
Delicate 40°C	-	-	Yes	Yes	-	-	-
Dual Pro Wash 60°C	-	-	-	-	-	-	Yes
Auto Delicate 30°C - 50°C	-	-	-	-	Yes	Yes	Yes
Auto Normal 50°C - 60°C	-	-	-	-	Yes	Yes	-
Auto Intensive 60°C - 70°C	-	-	-	-	Yes	Yes	Yes (50°C - 70°C)
Hygiene 70°C	-	Yes	Yes	Yes	Yes	Yes	Yes

*: X1C & X1E: with display versions

FULLY-INTEGRATED SLIM D SERIES 45cm Models	D12	D22	D32	D42	D41	D51	D52	D53
Prewash	Yes	Yes	Yes	Yes	Yes	-	-	-
Mini 18'	-	-	-	-	-	Yes	Yes	Yes
Eco 50°C	Yes	Yes	Yes	Yes	Yes	Yes	Yes	Yes
Intensive 65°C	Yes	Yes	Yes	-	-	Yes	-	-
Quick 30' 40°C	-	Yes	Yes	Yes	Yes	Yes	Yes	Yes
Super 50' 65°C	-	Yes	Yes	Yes	Yes	Yes	Yes	Yes
Delicate 40°C	-	-	Yes	-	-	-	-	-
Dual Pro Wash 60°C	-	-	-	-	-	-	-	Yes
Daily 60°C	-	-	Yes	-	-	-	-	-
Auto Delicate 30°C - 50°C	-	-	-	Yes	Yes	-	Yes	Yes
Auto Normal 50°C - 60°C	-	-	-	Yes	Yes	-	Yes	-
Auto Intensive 60°C - 70°C	-	-	-	Yes	Yes	-	Yes	Yes (50°C-70°C)
Hygiene 60°C	-	-	-	-	-	Yes	Yes	Yes
Hygiene 70°C	-	Yes	Yes	Yes	Yes	-	-	-

Semi-Integrated: T Series



T14: 7 programs, rinse-aid & salt indicators, child lock washing cycle indicators, half load (with one mode), display (remaining time, delay timer 1-24h), 3in1 tablet detergent option, e. rinse option

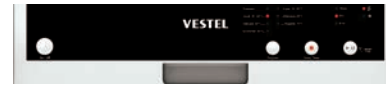

T15: 7 programs, rinse-aid & salt indicators, child lock, washing cycle indicators, delay timer (3-6-9hr)



T21: 8 programs, rinse-aid & salt indicators, child lock washing cycle indicators, half load (with three modes: lower basket / upper basket / half load on both baskets), display (remaining time, delay timer 1,24h), 3in1 tablet detergent option, extra rinse option, extra drying option

T22: 8 programs, rinse-aid & salt indicators, child lock, washing cycle indicators, half load (with three modes: lower basket / upper basket / half load on both baskets), display (remaining time, delay timer 1-24), 3in1 tablet detergent option, extra rinse option, extra drying option

T24: 8 programs, rinse-aid & salt indicators, child lock, washing cycle indicators, half load (with three modes: lower basket / upper basket / half load on both baskets), display (remaining time, delay timer 1-24), extra silent option, extra fast option, energy save option

Semi-Integrated: X Series



X13: 4 programs, rinse-aid & salt indicators, washing cycle indicators, half load option (with one mode), delay timer (3-6-9hr)



X15: 6 programs, rinse-aid & salt indicators, washing cycle indicators, half load option (with one mode), delay timer (3-6-9hr)



Extra features with display (X1C & X1E): Child lock option, display (remaining time, delay timer), delay timer (1-2-3-...-19hr)

Fully-Integrated: D Series

D42: 8 programs, rinse-aid & salt indicators, end of cycle indicator, audible signal (buzzer) at the end program, half load option (with three modes: lower basket / upper basket / half load on both baskets), display (remaining time, delay timer), delay timer (1-2-3-...-19hr), 3in1 tablet detergent option

D41: 8 programs, rinse-aid & salt indicators, end of cycle indicator, audible signal (buzzer) at the end program, half load option (with three modes: lower basket / upper basket / half load on both baskets), display (remaining time, delay timer), delay timer (1-2-3-...-19hr), 3in1 tablet detergent option

D32: 8 programs, rinse-aid & salt indicators, end of cycle indicator, audible signal (buzzer) at the end program, half load option (with one mode), display (remaining time, delay timer), delay timer (1-2-3-...-19hr), 3in1 tablet detergent option

D22: 6 programs, rinse-aid & salt indicators, end of cycle indicator, audible signal (buzzer) at the end program, half load option (with one mode), delay timer (3-6-9hr)

D12: 3 programs, rinse-aid & salt indicators, end of cycle indicator, audible signal (buzzer) at the end program

Spero	
Alinda	
Spero	
Alinda	
Spero	
Alinda	
Spero	
Alinda	
Spero	
Alinda	

3rd Rack

UPPER CUTLERY BASKET

The upper cutlery basket is designed to place forks, spoons and knives, long dippers and small items. You can take out the dishes along with the 3rd rack after washing. The Upper Cutlery Basket is composed of two pieces; You can take out left or right part of the upper cutlery basket to obtain more space for the dishes in the upper basket.



VarioSpace
EasyTray

*Cutlery plastic basket is optional.

T24 Vento

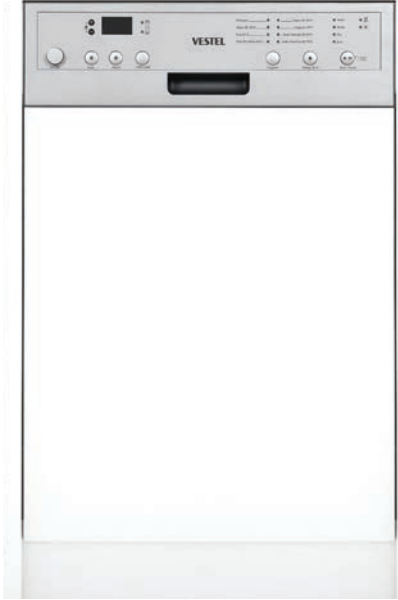

A+++

STANDARD FEATURES

10 place settings
 3rd Rack
 8 programs, 7+ temperatures
 Rinse aid / salt indicator
 Washing cycle indicators
 Child lock option
 Overflow and leakage protection
 Heater protection
 Half load option (with three modes)
 (lower basket/upper basket /half load on both baskets)
 Display (remaining time, delay timer)
 Delay timer (1-2-3-...-24hr)
 Energy save option
 Extra silent option
 Extra fast option
 9 lt water consumption

PERFORMANCE

A+++AA, 44 dB(A)

COLOR OPTIONS

White, Black, Dark Silver

T22 Vento

STANDARD FEATURES

10 place settings
 3rd Rack is optional
 8 programs, 7+ temperatures
 Rinse aid / salt indicator
 Washing cycle indicators
 Child lock option
 Overflow and leakage protection
 Heater protection
 Half load option (with three modes)
 (lower basket/upper basket /half load on both baskets)
 Display (remaining time, delay timer)
 Delay timer (1-2-3-...-24hr)
 3in1 tablet detergent option
 Extra dry option
 Extra rinse option
 9 lt water consumption

PERFORMANCE

A++AA, 52/49/47/45 dB(A)

COLOR OPTIONS

White, Black, Dark Silver

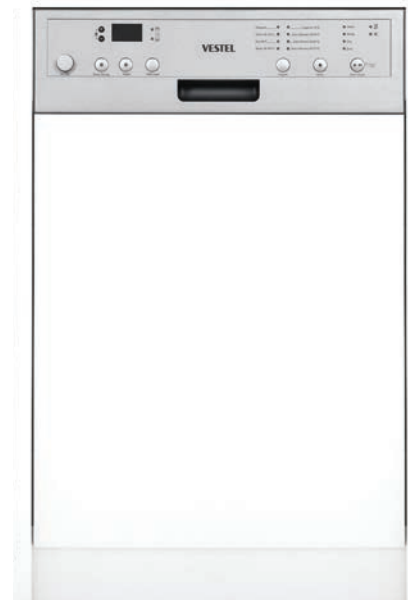

A++

T21 Vento

STANDARD FEATURES

10 place settings
 8 programs, 7+ temperatures
 Rinse aid / salt indicator
 Washing cycle indicators
 Child lock option
 Overflow and leakage protection
 Heater protection
 Half load option (with three modes)
 (lower basket/upper basket /half load
 on both baskets)
 Display (remaining time, delay timer)
 Delay timer (1-2-3-...-24hr)
 3in1 tablet detergent option
 Extra dry option
 Extra rinse option
 9 lt water consumption

PERFORMANCE

A++AA, 54/52/49/47/45 dB(A)*

COLOR OPTIONS

White, Black, Dark Silver

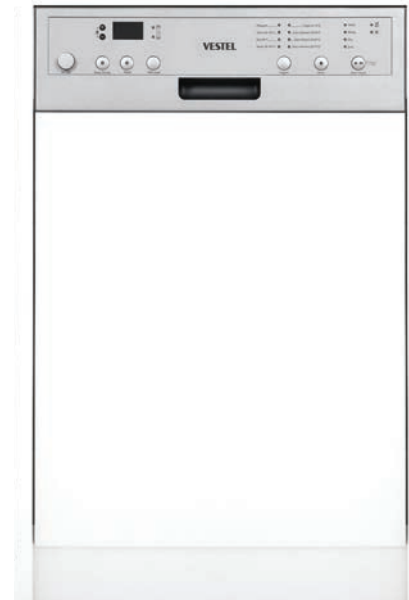

A++

* A+AA until April 2017

T15 Vento

STANDARD FEATURES

10 place settings
 7 programs, 4 temperatures
 Rinse aid / salt indicator
 Washing cycle indicators
 Child lock option
 Overflow and leakage protection
 Heater protection
 Delay timer (3-6-9hr)
 Overflow and leakage protection
 Heater protection
 11 lt water consumption*

PERFORMANCE

A++AA, 57/54/52/49/47/45 dB(A)**

COLOR OPTIONS

White, Black, Dark Silver

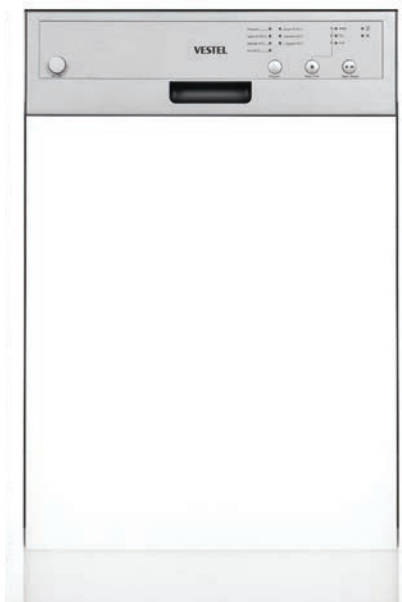

A++

* 13 lt until April 2017

** A+AA until April 2017

T14 Vento

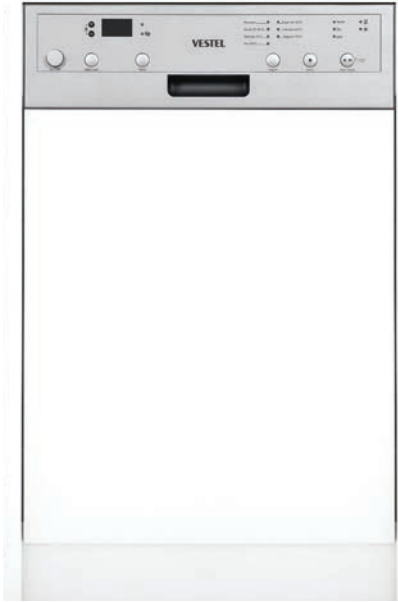

A⁺⁺

STANDARD FEATURES

10 place settings
 7 programs, 4 temperatures
 Rinse aid / salt indicator
 Washing cycle indicators
 Child lock option
 Overflow and leakage protection
 Heater protection
 Half load option (with one mode)
 Display (remaining time, delay timer)
 Delay timer (1-2-3-...-24hr)
 3in1 tablet detergent option
 Extra rinse option
 11 lt water consumption*

* 13 lt until April 2017

PERFORMANCE

A⁺⁺AA, 57/54/52/49/47/45 dB(A)**

COLOR OPTIONS

White, Black, Dark Silver

** A⁺⁺AA until April 2017

X15 & X1E with display

STANDARD FEATURES

10 place settings
 6 programs, 4 temperatures
 Rinse aid / salt indicator
 Washing cycle indicators
 Overflow and leakage protection
 Heater protection
 Half load option (with one mode)
 Delay timer (3-6-9hr)
 11 lt water consumption*

EXTRA FEATURES WITH DISPLAY

Display (remaining time, delay timer)
 Delay timer (1-2-3-...-19hr)
 Child lock option

* 13 lt until April 2017

PERFORMANCE

A⁺⁺AA, 57/54/52/49/47/45 dB(A)**

COLOR OPTIONS

a

** A⁺⁺AA until April 2017

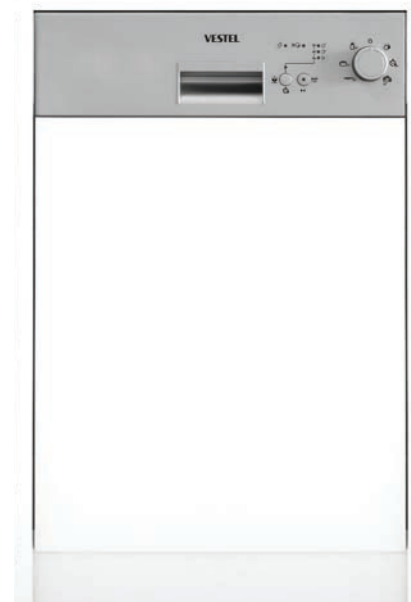

A⁺⁺

X13 & X1C with display

STANDARD FEATURES

10 place settings
 4 programs, 2 temperatures
 Rinse aid / salt indicator
 Washing cycle indicators
 Overflow and leakage protection
 Heater protection
 Half load option (with one mode)
 Delay timer (3-6-9hr)
 11 lt water consumption*

PERFORMANCE

A++AA, 57/54/52/49/47/45 dB(A)**

COLOR OPTIONS

White, Black, Dark Silver

EXTRA FEATURES WITH DISPLAY

Display (remaining time, delay timer)
 Delay timer (1-2-3-...-19hr)
 Child lock option

* 13 lt until April 2017

** A+AA until April 2017

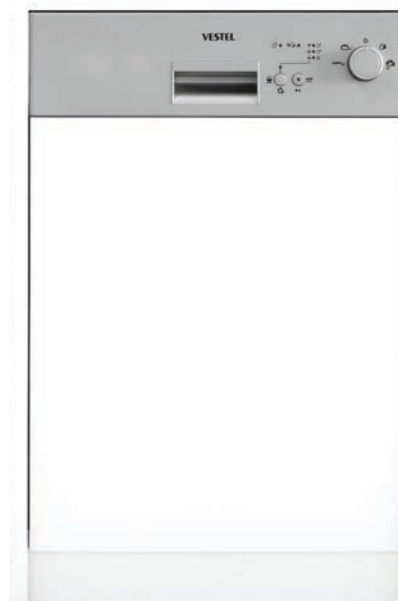

D53 - D52 - D51 Hemen

STANDARD FEATURES

6-8 Programs
 Touch Panel
 Rinse-Aid & Salt Indicators
 Audible Signal (Buzzer At The End Programme)
 Half Load Option (With Three Modes: Lower Basket / Upper Basket / Half Load On Both Baskets) (D53&D52)
 Half Load Option (With One Mode) (D51)
 Display (Remaining Time, Delay Timer)
 Delay Timer (1-2-3-...-19Hr)
 3In1 Tablet Detergent Option
 Extra Silent Option (D53)

Extra Fast Option (D53)
 Energy Save Option(D53)
 Extra Rinse Option(D52), Infoled (Optional)

PERFORMANCE

D53: A+++AA, 44 dB(A)
 D52: A++AA, 54/52/49/47/45 dB(A)
 D51: A++AA, 57/54/52/49/47/45 dB(A)**

* 13 lt until April 2017

** A+AA until April 2017



D41 Alinda



A++

STANDARD FEATURES

- 10 place settings
- 3rd Rack
- 8 programs, 7+ temperatures
- Rinse aid / salt indicator
- End of cycle indicator
- Overflow and leakage protection
- Heater protection
- Audible signal (buzzer) at the end program
- Half load option (with three modes) (lower basket/upper basket /half load on both baskets)
- Display (remaining time, delay timer)
- Delay timer (1-2-3-...-19hr)
- 3in1 tablet detergent option
- 9 lt water consumption

PERFORMANCE

A++AA, 52/49/47/45 dB(A)

* Spero is also available



D42 Spero

STANDARD FEATURES

- 10 place settings
- 8 programs, 7+ temperatures
- Rinse aid / salt indicator
- End of cycle indicator
- Overflow and leakage protection
- Heater protection
- Audible signal (buzzer) at the end program
- Half load option (with three modes) (lower basket/upper basket /half load on both baskets)
- Display (remaining time, delay timer)
- Delay timer (1-2-3-...-19hr)
- 3in1 tablet detergent option
- 12 lt water consumption

PERFORMANCE

A++AA, 52/49/47/45 dB(A)*

* Alinda is also available

* A+AA until April 2017



A++



D32 Spero

STANDARD FEATURES

- 10 place settings
- 8 programs, 6 temperatures
- Rinse aid / salt indicator
- End of cycle indicator
- Overflow and leakage protection
- Heater protection
- Audible signal (buzzer) at the end program
- Half load option (with one mode)
- Display (remaining time, delay timer)
- Delay timer (1-2-3-...-19hr)
- 3in1 tablet detergent option
- 11 lt water consumption*

* 13 lt until April 2017

PERFORMANCE

A++AA, 57/54/52/49/47/45 dB(A)**

* Alinda is also available

** A+AA until April 2017



D22 Spero

STANDARD FEATURES

- 10 place settings
- 6 programs, 4 temperatures
- Rinse aid / salt indicator
- End of cycle indicator
- Overflow and leakage protection
- Heater protection
- Audible signal (buzzer) at the end program
- Half load option (with one mode)
- Delay timer (3-6-9hr)
- 11 lt water consumption*

* 13 lt until April 2017

PERFORMANCE

A++AA, 57/54/52/49/47/45 dB(A)**

* Alinda is also available

** A+AA until April 2017





D12 Spero

STANDARD FEATURES

- 10 place settings
- 3 programs, 2 temperatures
- Rinse aid / salt indicator
- End of cycle indicator
- Overflow and leakage protection
- Heater protection
- Audible signal (buzzer) at the end program
- 11 lt water consumption*

PERFORMANCE

A++AA, 57/54/52/49/47/45 dB(A)**

* 13 lt until April 2017

* Alinda is also available

** A+AA until April 2017



SEMI-INTEGRATED

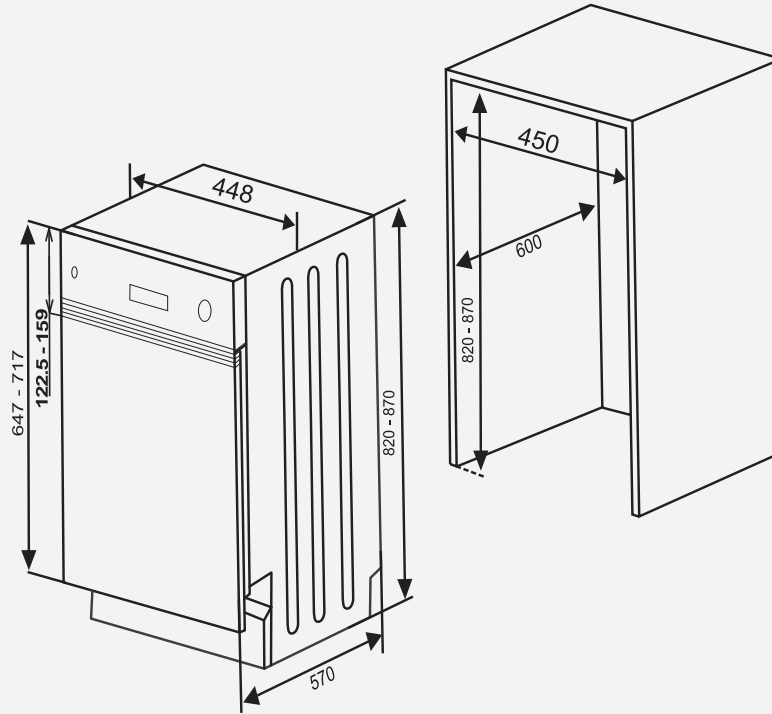

FULLY-INTEGRATED

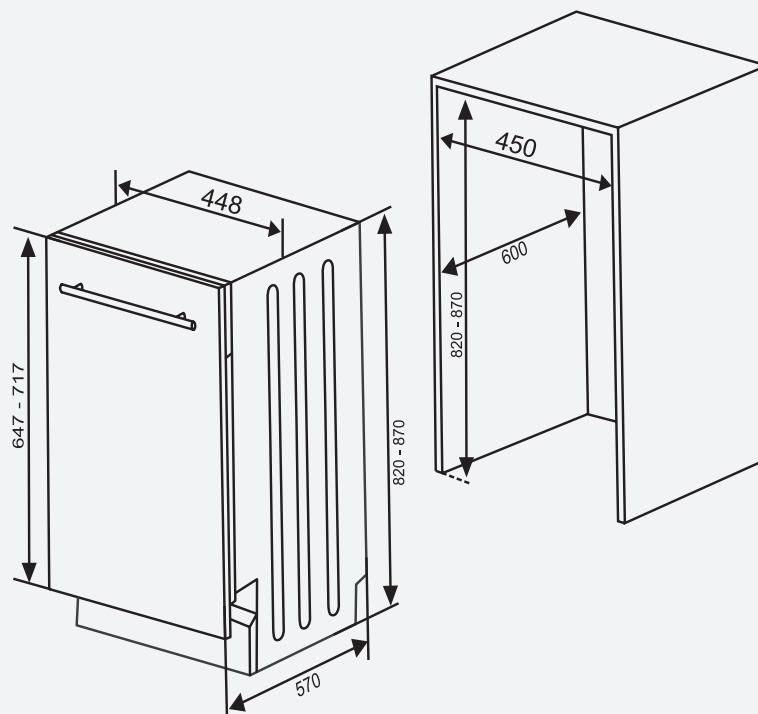

Ovens



Built-in Ovens			
Size	60LT	65LT	75LT
Oven	Electric	Electric	Electric
Hob Control	Yes / No	Yes / No	Yes / No
Cooling System	Yes / No	Yes / No	Yes / No
Self Clean (Pyro)	No	Yes / No	Yes / No

Built-in Hobs													
Size [cm]	60						70			78		90	
Hob	Gas	Mixed	Gas on Glass	Hotplate	Radiant	Induction	Gas	Mixed	Gas on Glass	Radiant	Induction	Gas	Induction
Control	Side Knob Front Knob	Side Knob Front Knob	Side Knob Front Knob	Side Knob On Built-in Oven	Side Knob Side Touch Front Touch On Built-in Oven	Front Touch On Built-in Oven	Front Knob	Front Knob	Front Knob	Front Touch	Front Touch	Front Knob	Front Touch

Domino Hobs					
Size [cm]	30				
Hob	Gas	Gas on Glass	Hotplate	Radiant	Induction
Control	Front Knob	Front Knob	Front Knob	Front Knob Front Touch	Front Touch

Freestanding Hobs				
Size [cm]	60			
Hob	Gas	Gas on Glass	Mixed	Hotplate
Control	Side Knob	Front Knob	Side Knob	Side Knob

ready
cook



PRODUCT / ACCESSORY DESCRIPTION

Ready Cook is a new TFT interface with click type knob control for built in ovens.

We're very pleased to bring the color and clarity of TFT displays to a broader range of major home appliances with Vestel's Ready Cook, along with other advanced features previously available only in more high-end oven models.

Ready Cook is designed to help users cook professional recipes easily with auto cooking functions, also allowing the users to implement their own recipes with manual cooking functions. Using a user friendly interface with the colored TFT display creates the charm of Ready Cook compared to the existing models in the high end segment.

FEATURES

- 4.3" TFT LCD Display
- Auto Cooking mode with 150 recipes
- Manuel Cooking mode
- Favorites with 10 recipe slots which can be set by end user
- Vap Clean function
- Multi language support
- Real time clock and date adjustment
- 5 levels of display brightness
- 3 levels of buzzer tone
- 10 language option
- Wi-Fi option
- A+ energy efficiency option
- A++ energy efficiency option

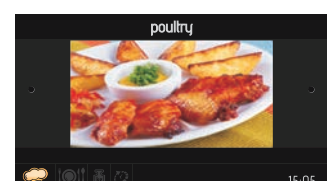
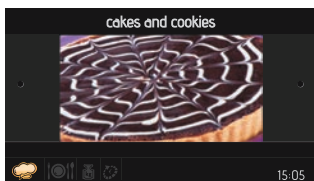
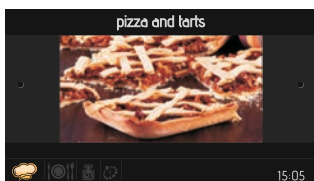
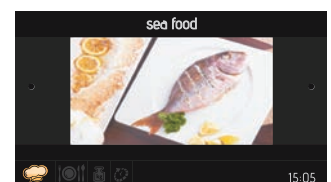
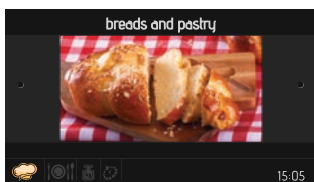
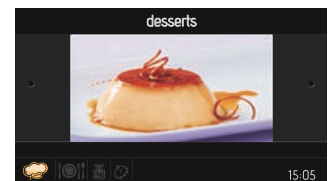
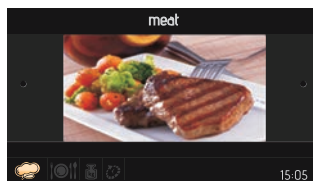
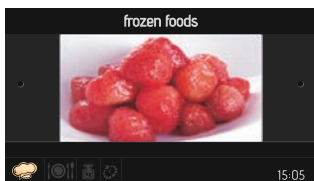
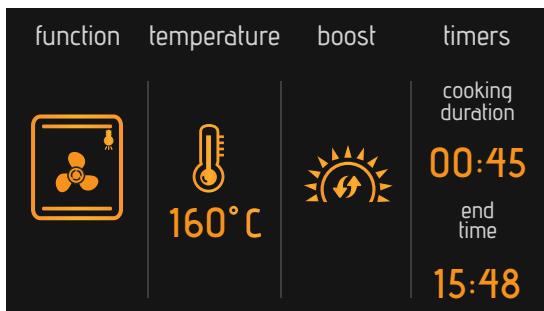
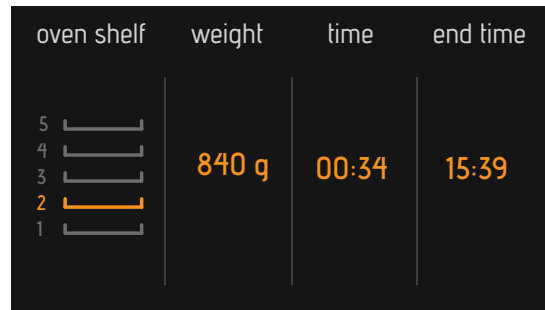
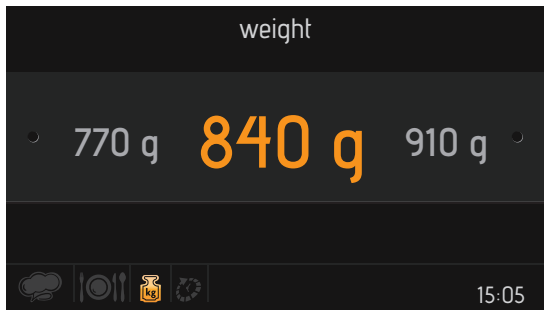

VapClean® Function



With VapClean®, function, dried food stains inside the oven cavity is softened with vapor.

To perform VapClean®, a glass of water is poured into the small tray which will be placed at the bottom of the oven. After that, VapClean® function is activated to create vapor inside oven cavity which will soften dried food stains.

Pyrolysis Function

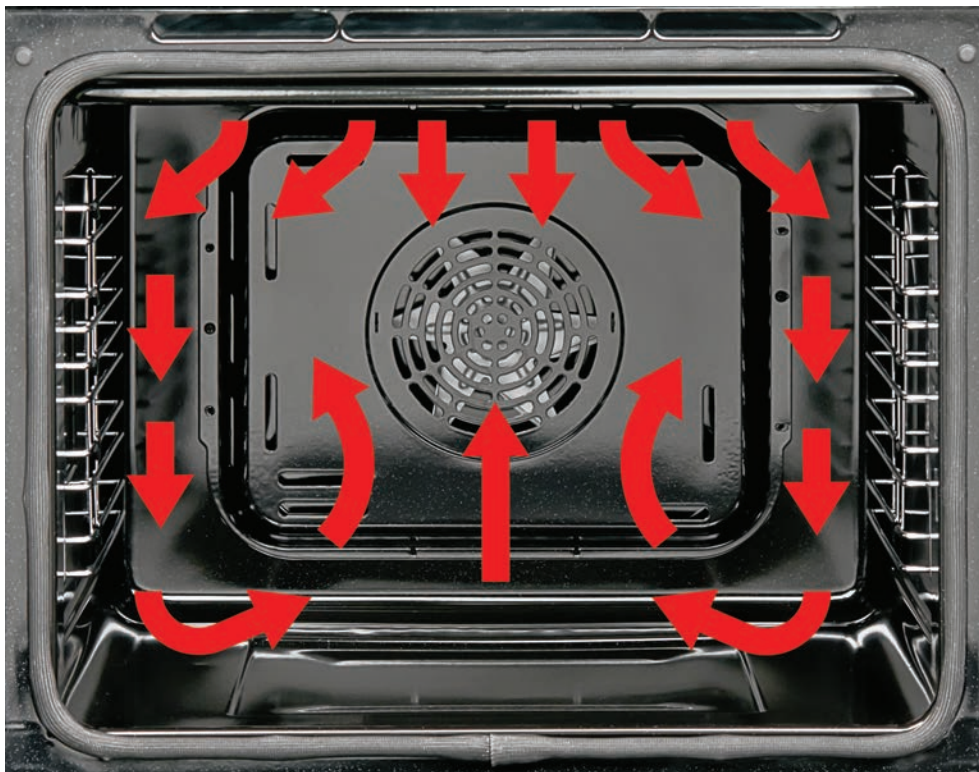

Pyrolysis

During the pyrolytic cleaning process, the oven heats up to approximately 480°C at which the temperature is kept for 1 hour while the door is locked for safety purposes.

At this temperature, residues from roasting, grilling and baking are reduced to a thin layer of ash that can simply be wiped away with a damp cloth.



TYPE 1
Small Glass Oven Door



TYPE 2
Large Glass Oven Door



TYPE 3
Pyrolytic Oven Door



TYPE 4
Full Glass Oven Door



TYPE 5
Active Cool Oven Door



DOOR FEATURES

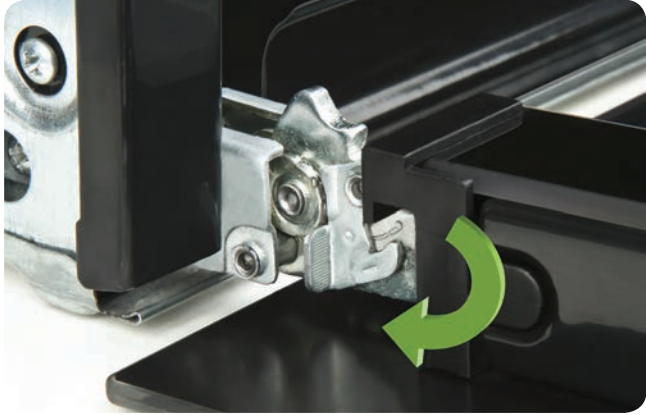

EASY TO REMOVE OVEN DOOR
(FOR FULL INNER GLASS OVER DOOR)



EASY TO REMOVE OVEN DOOR



REMOVABLE INNER GLASS



DOOR SWITCH



SOFT CLOSE



ACTIVE COOL DOOR

I -Type Add On
17mm (Lazer Cut)



I -Type Add On
50mm (Cladding)



I -Type Add On
65mm (Cladding)



U -Type Add On
17mm (Lazer Cut)



U -Type Add On
50mm (Cladding)



U -Type Add On 65mm (Cladding)

U -Type Add On
65mm (Cladding)



O -Type Add On
50mm (Cladding)



O -Type Add On
85mm (Cladding)



Mono Stripe Add
On 17mm (Lazer
Cut)



Mono Stripe Add
On 50mm (Lazer
Cut)



Mono Stripe
Add On 80mm
(Lazer Cut)



Mono Stripe
Add On 80mm
(Lazer Cut)



Duo Stripe Add On (Lazer Cut)

Trio Stripe Add On (Lazer Cut)



Corner Add On (Lazer Cut)

Visio Touch Add On (Lazer Cut)



Visio Display Add On (Lazer Cut)

Smart LCD Add On (Lazer Cut)

ADD-ON TYPES FOR 75 LT BUILT-IN OVENS

I Type Add On
40mm (Cladding)



U Type Add On
17mm (Lazer Cut)



U Type Add On
40mm (Cladding)



O Type Add On
40mm (Cladding)



Mono Stripe Add On 40mm (Lazer Cut)

Duo Stripe Add On 40mm (Lazer Cut)



Smart Lcd Ready Cook Control Panel



Monochrome Lcd Control Panel



Full Touch Led Control Panel



Visio Display Control Panel



Visio Touch Control Panel



Visio Touch Metal Control Panel



Digital Touch Timer



Digital Touch Timer For Metal Control Panel



Digital Full Programmer



Digital Full Programmer For Metal Control Panel

CONTROL PANEL TYPES



Pyrolytic Digital Programmer



Pyrolytic Digital Programmer For Metal Control Panel

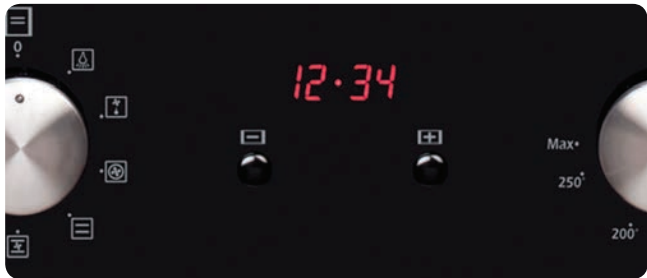

Digital Clock & Minute Minder



Digital Clock & Minute Minder For Metal Control Panel

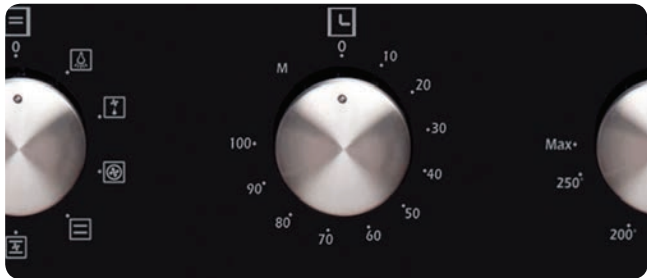

Mechanical Timer



Mechanical Timer For Metal Control Panel

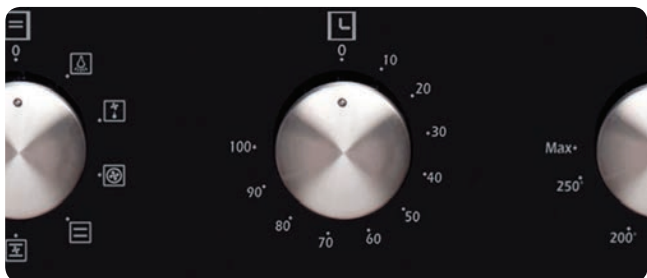

Mechanical Minute Minder



Mechanical Minute Minder For Metal Control Panel



Analog Timer



Analog Timer For Metal Control Panel



Enamel Mold Runners



Enamel Cavity With Mold Runners



Catalytic Enamel Side Panels



Catalytic Enamel Side And Rear Panels

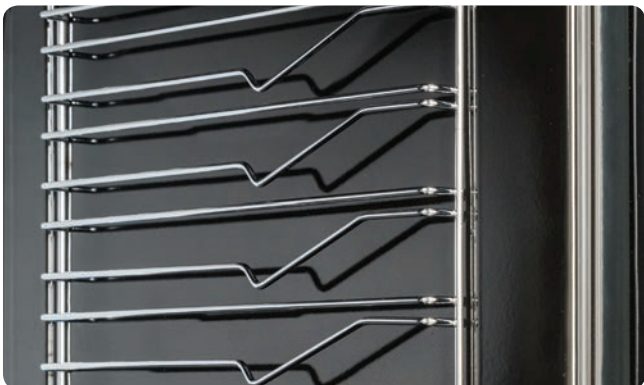

Wire Rack In Enamel Cavity



Wire Racks In Enamel Cavity



Wire Rack In Catalytic Enamel Cavity



Catalytic Enamel Panel With Side Wire Racks

TELESCOPIC SHELF TYPES



Single Telescopic Shelf



Double Telescopic Shelves

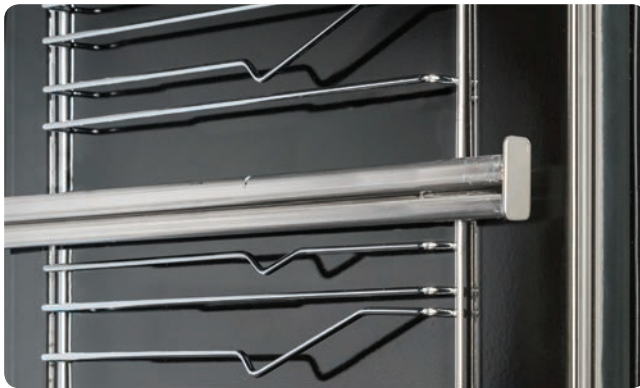

Full Extension Telescopic Shelf

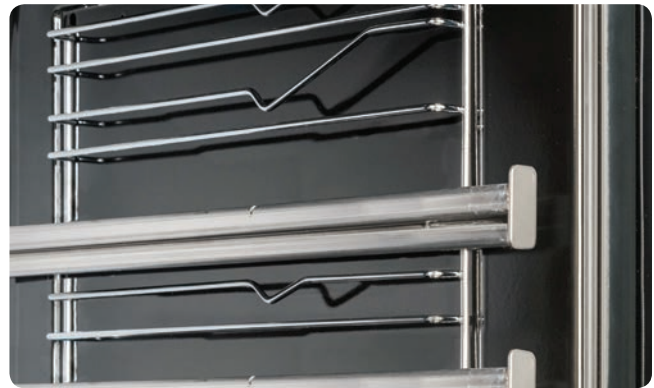

Double Full Extension Telescopic Shelves



Telescopic



Full Extension Telescopic



Telescopic Shelves Stabilizer



Telescopic Shelves Stabilizer

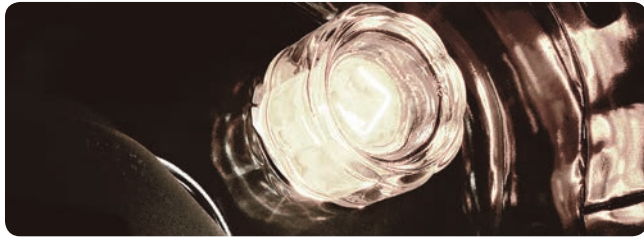

Oven Lamp



Side Lighting



Electric Grill

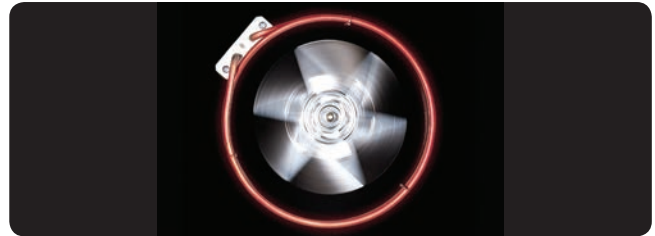

Fan With The Ring For Multifunction Ovens

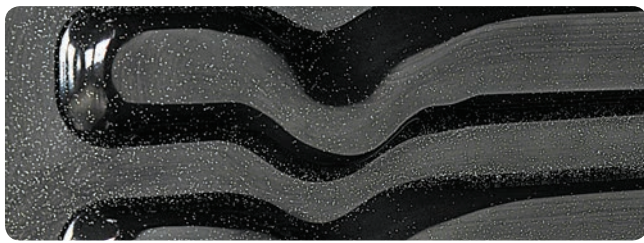

Pyrolytic Enamel



Pop in Pop Out Illuminated Knobs



Serigraphy On Knob Ring



Mirror Glass



Anti Fingerprint Inox Parts



Cooling Fan



Water Tank



Child Lock

KNOB TYPES



Alfa



Antero



Big Antero



Delta Ring



Delta



Eclipse Ring



Eclipse



Gama Ring



Gama



Nord Ring



Nord



Omega



Epsilon



Rimo



Big Rimo



Big Macro



Big Macro Ring



Small Macro



Small Macro with Ring



Pop in Pop Out (PIPO)



Jannu



Jannu Ring



Spectrum



Vesta



Trio



Big Trio



Vario



Vario Ring



Zeta



Zeta Ring



Rustic Risus



Rustic Risus with Ring



Sigma



Zenith



Feros

HANDLE TYPES



3D Quadrangle



Arc Quadrangle



Arc Tube



Bow



Curved Quadrangle

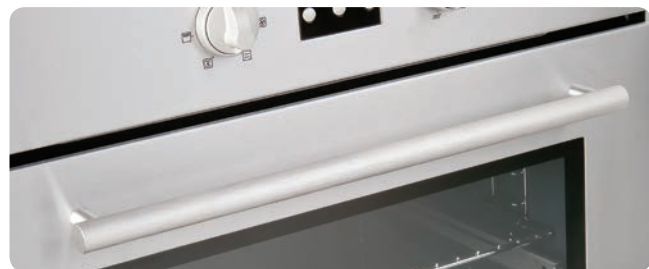

Cylinder



D Profile Arc



Ellipse Arc



Flat Quadrangle



Flat Slice



Metalux



Risus



Trio



Troy



Vero



Without Cooling Fan Type

ACCESSORIES



Shallow Tray



Deep Tray



80 mm Deep Tray



Grill Pan Handle Set



Chromed Wire Grid



Chromed Wire Grid For Deep Tray



Glass Tray



Round Tray And Grid Set



Pizza Stone and Shovel (Pizza Set)



Oil Filter



Meat Probe

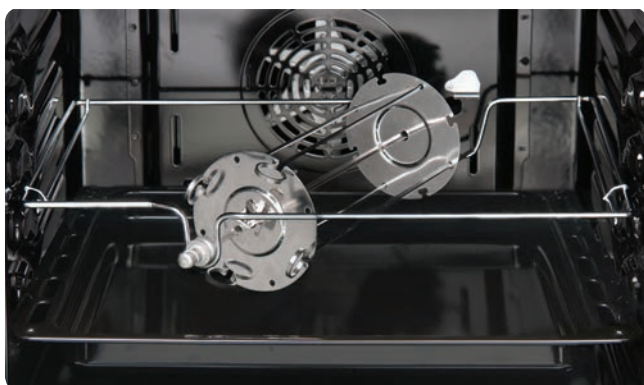

Multi Purpose Rotisserie



Turnspit Set With Grid



Turnspit Set With Metal Bracket

GENERAL SPECIFICATIONS

60cm BUILT-IN OVEN SPECIFICATION SHEET	60cm ELECTRIC BUILT-IN OVEN	60cm PYROLYTIC BUILT-IN OVEN	60cm ELECTRIC POLYVALENTE BUILT-IN OVEN
Available Colours			
White	Standard	Standard	Standard
Black	Optional	Optional	Optional
Stainless Steel	Optional	Optional	Optional
Terre de France	Optional	Optional	Optional
Mink	Optional	Optional	Optional
Claret Red	Optional	Optional	Optional
Cream	Optional	Optional	Optional
Rustic (White / Black / Cream)	Optional	Optional	Optional
Silver	Optional	Optional	Optional
Control Panel			
Metal	Standard	Standard	Standard
Glass	Optional	Optional	Optional
Various Types of Inox Add-on on Glass Control Panel	Optional	Optional	Optional
Oven Features			
Easy to Clean Enamel	Standard	-	Standard
Catalytic Enamel Panels (Left, right and rear)	Optional	-	Optional
Pyrolytic Enamel		Standard	
Wire Side Racks	Optional	Optional	Optional
Telescopic Rails (1 or 2 racks)	Optional	Optional	Optional
Top Heating Element	Standard	Standard	Standard
Bottom Heating Element	Standard	Standard	Standard
Thermostat	Standard	Electronic	Standard
Grill (Thermostatic)	Optional	Optional	Optional
Double Grill (Thermostatic)	Optional	Optional	Optional
Fan	Optional	Optional	Optional
Fan with Ring Heating Element	Optional	Optional	Optional
Automatic Boost Function	available for some control unit	available for some control unit	available for some control unit
Turnspit	Optional	Optional	Optional
Thermostat Operation Indicator Light	Standard	Standard	Standard
Oven Operation Indicator Light	Standard	-	-
Hotplate Operation Indicator Light (in case of polyvalente oven)	-	-	Standard
Oven Door Switch	Optional	Standard	Optional
Oven Door lock indicator light	-	Standard	-
Minute Minder	Optional	-	Optional
Mechanical Timer	Optional	-	Optional
Analog Timer	Optional	-	Optional
Digital Clock	Optional	-	Optional
Digital Programmer	Optional	Standard	Optional
Digital Programmer with touch interface			
Full Touch LED Display	Optional	Optional	Optional
Knob Control LED Display and Touch Interface (Visio Touch)	Optional	Optional	-
Knob Control LED Display (Visio Display)	Optional	-	-
Smart LCD (Ready Cook)	Optional	-	-
Monochrome LCD	Optional	-	-
Oven Door			
Full outer glass and small inner glass with metal frame (4 glasses)	-	Standard	-
Full inner glass and full glass front face (4 glasses) Oven Door	-	Optional	-
Full outer glass and Inner metal door (small glass) Oven Door	Standard	-	Standard
Full outer glass and full inner glass Oven Door	Optional	-	Optional
Full inner glass and full glass front face Oven Door	Optional	-	Optional
Cool touch Oven door	Optional	-	Optional
Flotal Oven Door Glass	Optional	-	Optional
Removable Oven Door	Standard	Standard	Standard
Various Types of Inox Add-on on Oven Door Glass	Optional	Optional	Optional
Child Lock on Oven Door	Optional	Standard (Electromechanic)	Optional
Accessories			
Oven Light (25W)	Optional	Standard	Optional
Oil Filter	Optional	Optional	Optional
Meat Probe	Optional	-	Optional
Baking Tray (Shallow Tray)	Optional	1	Optional
Roasting Tray (Deep Tray)	1	Optional	1
Glass Tray	Optional	Optional	Optional
Chromed Grid with Stoper	1	1	1
Wire grid for deep tray	Optional	Optional	Optional
Broil Pan with Handle Set	Optional	Optional	Optional
Multi Purpose Roriserie	Optional	Optional	Optional
Turnspit	Optional	Optional	Optional
Packaging			
Shrink Packaging	Optional	Optional	-
Carton Box Packaging	Optional	Optional	Standard



BO.110 Ready Cook

FEATURES

- 60 cm single built-in electric oven
- 75 lt inner cavity
- Steam-assisted cooking
- Knob control slim Smart Lcd ready cook panel
- Inox knob
- Inox handle
- Wide visible area oven door
- Horizontal slim and bold laser cut inox add-on

BO.94 Ready Cook

FEATURES

- 60 cm single built-in electric oven
- 75 lt inner cavity
- Knob control slim Smart Lcd ready cook panel
- Inox knob
- Inox handle
- U type slim laser cut inox add-on control panel
- U type slim laser cut inox add-on oven door
- Wide visible area oven door



BO.105 Ready Cook

FEATURES

- 60 cm single built-in electric oven
- 75 lt inner cavity
- Slim monochrome Lcd control panel
- Black glass control panel and oven door
- Black handle
- Wide visible area oven door



BO.109 Full Touch

FEATURES

- 60 cm single built-in electric oven
- 75 lt inner cavity
- Slim full touch led control Panel
- Amber colored diplay
- Inox handle
- Side vertical inox cladding add-on control panel
- Side vertical inox cladding add-on oven door
- Wide visible area oven door

BO.106 Visio Touch

FEATURES

- 60 cm single built-in electric oven
- 75 lt inner cavity
- Visio Touch Metal Control Panel
- Slim inox control panel
- Amber colored diplay
- Inox pop-in pop-out knobs
- Inox handle
- Wide visible area oven door
- Horizontal bold laser cut inox add-on oven door



BO.96 Visio Touch

FEATURES

- 60 cm single built-in electric oven
- 75 lt inner cavity
- Visio Touch Control Panel
- Amber colored diplay
- Inox pop-in pop-out knobs
- Inox handle
- White optical glass slim control panel
- White optical glass oven door
- Wide visible area oven door



BO.98

FEATURES

- 60 cm single built-in electric oven
- 75 lt inner cavity
- Inox slim control panel
- Inox knob
- Inox handle
- Side vertical inox cladding add-on oven door
- Digital Full Programmer
- Wide visible area oven door

BO.97

FEATURES

- 60 cm single built-in electric oven
- 75 lt inner cavity
- White knobs
- White handle
- White optical glass slim control panel
- White optical glass oven door
- Digital Touch Timer
- Wide visible area oven door



BO.99

FEATURES

- 60 cm single built-in electric oven
- 75 lt inner cavity
- Inox pop-in pop-out knobs
- Inox handle
- O type inox cladding add-on control panel
- O type inox cladding add-on oven door
- Mechanical timer
- Wide visible area oven door





BO.67 Pyro

FEATURES

- 60 cm single built-in electric oven
- Pyrolytic Function
- Full Touch Led control panel
- Inox handle
- Horizontal slim laser cut inox add-on control panel
- Horizontal bold laser cut inox add-on oven door
- Amber colored display

BO.85 Pyro

FEATURES

- 60 cm single built-in electric oven
- Pyrolytic Function
- Visio Touch Metal Control Panel
- Inox pop-in pop-out knobs
- Inox handle
- Side vertical inox cladding add-on oven door
- Amber colored display



BO.84 Pyro

FEATURES

- 60 cm single built-in electric oven
- Pyrolytic Function
- Visio Touch Control Panel
- Inox pop-in pop-out knobs
- Inox handle
- Horizontal bold laser cut inox add-on oven door
- Amber colored display





BO.65 Pyro

FEATURES

- 60 cm single built-in electric oven
- Pyrolytic Function
- Pyrolytic Digital Programmer
- Inox knobs
- Inox handle
- Side vertical inox cladding add-on oven door
- U type cladding inox add-on control panel

BO.89 Pyro

FEATURES

- 60 cm single built-in electric oven
- Pyrolytic Function
- Pyrolytic Digital Programmer
- Inox pop-in pop-out knobs
- Inox handle
- Horizontal laser cut inox add-on oven door



BO.90 Pyro

FEATURES

- 60 cm single built-in electric oven
- Pyrolytic Function
- Pyrolytic Digital Programmer
- White glass control panel
- White glass oven door



BO.86 Ready Cook

FEATURES

- 60 cm single built-in electric oven
- Knob control Smart Lcd ready cook panel
- Inox knob
- Inox handle
- U type cladding inox add-on control panel
- U type cladding inox add-on oven door
- Anti-fingerprint inox part

BO.87 Ready Cook

FEATURES

- 60 cm single built-in electric oven
- Knob control Smart Lcd ready cook panel
- Inox knob
- Inox handle
- Mirror glass control panel and over door
- Side vertical cladding inox add-on control panel
- Side vertical cladding inox add-on oven door



BO.88 Ready Cook

FEATURES

- 60 cm single built-in electric oven
- Steam-assisted cooking
- Knob control Smart Lcd ready cook panel
- Inox knob
- Inox handle
- Black glass control panel and over door





BO.66 Full Touch

FEATURES

- 60 cm single built-in electric oven
- Full Touch Led control panel
- Inox handle
- Horizontal slim laser cut inox add-on control panel
- Horizontal bold laser cut inox add-on oven door
- Amber colored display

BO.70 Full Touch

FEATURES

- 60 cm single built-in electric oven
- Full Touch Led control panel
- Inox handle
- Side vertical cladding inox add-on control panel
- Side vertical cladding inox add-on oven door
- Amber colored display
- Wide visible area oven door



BO.77 Visio Touch

FEATURES

- 60 cm single built-in electric oven
- Visio Touch Control Panel
- Amber colored illuminated Inox pop-in pop-out knobs
- Inox handle
- Horizontal slim laser cut inox add-on control panel
- Horizontal bold laser cut inox add-on oven door



BO.75 Full Touch

FEATURES

- 60 cm single built-in electric oven
- Full Touch Led control panel
- Inox handle
- Horizontal bold laser cut inox add-on oven door
- Amber colored display

BO.78 Visio Touch

FEATURES

- 60 cm single built-in electric oven
- Visio Touch Control Panel
- Inox pop-in pop-out knobs
- Inox handle
- White optical glass control panel and oven door
- U type cladding inox add-on control panel
- U type cladding inox add-on oven door
- Amber colored display
- Wide visible area oven door



BO.83 Visio Touch

FEATURES

- 60 cm single built-in electric oven
- Visio Touch Control Panel
- Amber colored display
- Inox pop-in pop-out knobs
- Inox handle
- Laser-cut visio inox cladding on control panel
- Horizontal slim and horizontal add-on
- Laser-cut inox cladding on oven door



BO.81 Visio Display

FEATURES

- 60 cm single built-in electric oven
- Visio Display Control Panel
- Inox pop-in pop-out knobs
- Inox handle
- Visio lazer cut inox add-on control panel
- U type lazer cut inox add-on oven door
- Amber colored display

BO.92 Visio Display

FEATURES

- 60 cm single built-in electric oven
- Visio Display Control Panel
- Black pop-in pop-out knobs
- Black handle
- Black glass control panel and oven door
- Amber colored display



BO.93 Visio Display

FEATURES

- 60 cm single built-in electric oven
- Visio Display Control Panel
- Inox pop-in pop-out knobs
- Inox handle
- White optical glass control panel and oven door
- Amber colored display



BO.100

FEATURES

- 60 cm single built-in electric oven
- Digital touch timer
- Inox knobs
- Inox handle
- Side vertical laser-cut inox add-on control panel
- Side vertical laser-cut inox add-on oven door
- Wide visible area oven door

BO.74

FEATURES

- 60 cm single built-in electric oven
- Amber colored illuminated pop-in pop-out knobs
- Inox handle
- U type slim laser cut inox add-on control panel
- U type slim laser cut inox add-on oven door
- Digital full programmer



BO.05

FEATURES

- 60 cm single built-in electric oven
- Inox knobs
- Inox handle
- Black glass control panel and oven door
- U type cladding inox add-on control panel
- U type cladding inox add-on oven door
- Digital full programmer





BO.60

FEATURES

- 60 cm single built-in electric oven
- Inox knobs
- Inox handle
- Black glass control panel and oven door
- O type special inox effect serigraphy on control panel
- O type special inox effect serigraphy on oven door
- Digital full programmer

BO.09

FEATURES

- 60 cm single built-in electric oven
- White knobs
- White handle
- Black glass control panel and oven door
- Side vertical white serigraphy on control panel
- Side vertical white serigraphy on oven door
- Mechanical timer



BO.11

FEATURES

- 60 cm single built-in electric oven
- Silver knobs
- Inox handle
- Silver optical glass control panel and oven door
- Side vertical cladding inox add-on control panel
- Side vertical cladding inox add-on oven door
- Digital full programmer



BO.42

FEATURES

- 60 cm single built-in electric oven
- Inox knobs
- Inox handle
- Inox glass control panel and oven door
- Side vertical cladding inox add-on control panel
- U type cladding inox add-on oven door
- Digital full programmer

BO.13

FEATURES

- 60 cm single built-in electric oven
- Inox pop-in pop-out knobs
- Inox handle
- White optical glass control panel
- White optical glass oven door
- Side vertical cladding inox add-on control panel
- Side vertical cladding inox add-on oven door
- Digital full programmer



BO.14

FEATURES

- 60 cm single built-in electric oven
- Inox knobs
- Inox handle
- O type cladding inox add-on oven door
- Digital touch timer



BO.39

FEATURES

- 60 cm single built-in electric oven
- Inox knob
- Inox handle
- Mirror glass oven door
- Mechanical timer

BO.82

FEATURES

- 60 cm single built-in electric oven
- Inox pop-in pop-out knobs
- Inox handle
- Corner type laser cut inox add-on control panel
- Horizontal bold laser cut inox add-on oven door
- Digital full programmer



BO.15

FEATURES

- 60 cm single built-in electric oven
- Inox knobs
- Inox handle
- Inox control panel
- O type cladding inox add-on oven door
- Mechanical timer



BO.17

FEATURES

- 60 cm single built-in electric oven
- Inox knobs
- Inox handle
- Inox control panel
- Horizontal bold laser cut inox add-on oven door
- Mechanical timer

BO.18

FEATURES

- 60 cm single built-in electric oven
- Inox knobs
- Inox handle
- Inox control panel
- Black glass oven door



BO.36

FEATURES

- 60 cm single built-in electric oven without cooling fan
- Inox knobs
- Inox handle (without cooling fan type)
- Inox control panel
- Black glass oven door
- Digital clock (not programmer)





BO.73

FEATURES

- 60 cm single built-in electric oven
- Black knobs
- Black handle
- Special black hairline cladding add-on control panel
- Special black hairline cladding add-on oven door
- Digital full programmer

BO.22

FEATURES

- 60 cm single built-in electric oven
- Black knobs
- Black handle
- Silver glass control panel
- Silver glass oven door
- Digital full programmer
- Front face serigraphy application



BO.38

FEATURES

- 60 cm single built-in electric oven
- Inox knobs
- Inox handle
- Inox glass control panel
- Inox glass oven door
- Digital full programmer
- Front face serigraphy application





BO.24

FEATURES

- 60 cm single built-in electric oven
- Inox knobs
- Inox handle
- Black glass control panel
- Black glass oven door
- Digital Clock & Minute Minder (not programmer)

BO.37

FEATURES

- 60 cm single built-in electric oven
- Black knobs
- Black handle
- Black painted metal control panel
- Black glass oven door
- Digital Clock & Minute Minder (not programmer)



BO.25

FEATURES

- 60 cm single built-in electric oven
- Black knobs
- Black handle
- TDF optical glass control panel
- TDF optical glass oven door
- Mechanical timer





BO.26

FEATURES

- 60 cm single built-in electric oven
- White knobs
- White handle
- White glass control panel
- White glass oven door
- Digital Clock & Minute Minder (not programmer)
- Front face serigraphy application

BO.29

FEATURES

- 60 cm single built-in electric oven
- White knobs
- White handle
- White painted metal control panel
- White glass oven door
- Mechanical timer



BO.30

FEATURES

- 60 cm single built-in electric oven
- White knobs
- White handle
- White painted metal control panel
- White glass oven door





BO.107 Rustic

FEATURES

- 60 cm single built-in electric oven
- Rustic style Risus knobs
- Rustic style Risus handle
- Black Colored Rustic Metal Art Design Control Panel and Oven Door
- Analog timer

BO.108 Rustic

FEATURES

- 60 cm single built-in electric oven
- Rustic style Risus knobs
- Rustic style Risus handle
- Sand Colored Rustic Metal Art Design Control Panel and Oven Door
- Analog timer



BO.48 Rustic

FEATURES

- 60 cm single built-in electric oven
- Rustic style Risus knobs
- Rustic style Risus handle
- Type-C rustic design artwork
- Black glass control panel and oven door
- Mechanical timer





BO.50 Rustic

FEATURES

- 60 cm single built-in electric oven
- Rustic style Risus knobs
- Rustic style Risus handle
- Type-C rustic design artwork
- Sand color optical glass control panel
- Sand color optical glass oven door
- Mechanical timer

BO.47 Rustic

FEATURES

- 60 cm single built-in electric oven
- Rustic style Risus knobs
- Rustic style Risus handle
- Type-A rustic design artwork
- Green optical glass control panel
- Green optical glass oven door
- Analog timer

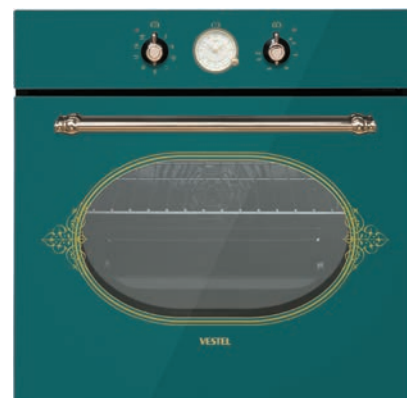

BO.46 Rustic

FEATURES

- 60 cm single built-in electric oven
- Rustic style Risus knobs
- Rustic style Risus handle
- Type-B rustic design artwork
- White optical glass control panel
- White optical glass oven door





BO.101 Combi

FEATURES

- 60 cm combi electric oven
- 75 lt inner cavity
- Inox pop-in pop-out knobs
- Inox handle
- Black glass slim control panel
- Digital touch timer
- Wide visible area oven door

BO.111 Combi

FEATURES

- 60 cm combi electric oven
- 75 lt inner cavity
- Inox knobs
- Inox handle
- Inox slim control panel
- O type inox cladding add-on oven door
- Digital touch timer
- Wide visible area oven door



BO.102 Combi

FEATURES

- 60 cm combi electric oven
- 75 l inner cavity
- Inox pop-in pop-out knobs
- Inox handle
- Inox slim control panel
- Digital full programmer
- Wide visible area oven door



BO.103 Combi

FEATURES

- 60 cm combi electric oven
- 75 lt inner cavity
- Inox pop-in pop-out knobs
- Inox handle
- Inox slim control panel
- U type inox cladding add-on oven door
- Mechanical timer
- Wide visible area oven door

BO.91 Visio Touch Combi

FEATURES

- 60 cm combi electric oven
- Visio Touch Control Panel
- Black glass control panel
- Inox pop-in pop-out knobs
- Inox handle
- Horizontal bold laser-cut inox cladding on oven door



BO.01 Combi

FEATURES

- 60 cm combi electric oven
- Inox pop-in pop-out knobs
- Inox handle
- Black glass control panel and oven door
- O type inox cladding add-on control panel
- U type inox cladding add-on oven door
- Digital full programmer



BO.104 Combi

FEATURES

- 60 cm combi electric oven
- Inox knobs
- Inox handle
- Black glass control panel and oven door
- Horizontal slim laser cut inox add-on control panel
- Horizontal laser cut inox add-on oven door
- Digital touch timer

BO.02 Combi

FEATURES

- 60 cm combi electric oven
- Inox pop-in pop-out knobs
- Inox handle
- Inox control panel
- Side vertical cladding inox add-on oven door
- Large display digital programmer



BO.58 Combi

FEATURES

- 60 cm combi electric oven
- White metal control panel
- White knobs
- White handle
- Black glass oven door
- O type white metal cladding add-on oven door
- Mechanical timer





BO.61 Rustic Combi

FEATURES

- 60 cm combi electric oven
- Rustic style Risus knobs
- Rustic style Risus handle
- Type-C rustic design artwork
- Black glass control panel and oven door

BO.69 Combi

FEATURES

- 60 cm combi electric oven
- Inox pop-in pop-out knobs
- Inox handle
- White optical glass control panel and oven door
- Side vertical cladding inox add-on control panel
- Side vertical cladding inox add-on oven door
- Digital full programmer



BO.34 Combi

FEATURES

- 60 cm combi electric oven without cooling fan
- White knobs
- White handle (without cooling fan type)
- White metal control panel
- Black glass oven door
- U type white serigraphy on oven door

Hobs



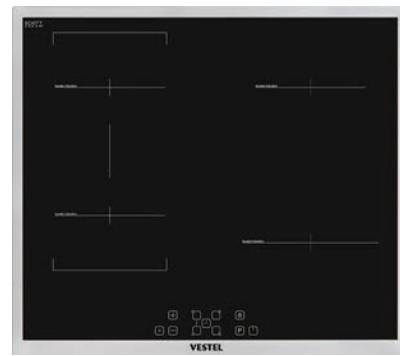
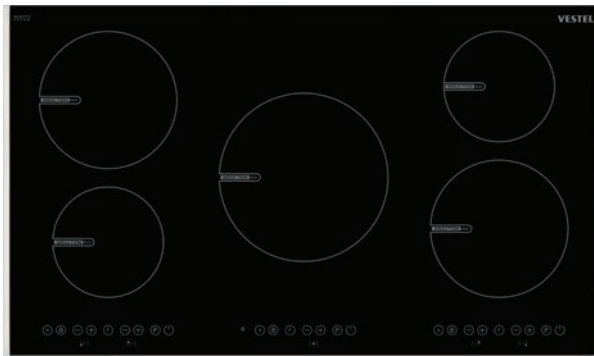

Vestel Induction Hobs



100% Vestel Induction Technology



Easy to Use with touch control unit



High Efficiency with low energy consumption



Thermal cut off system
Safe usage with pan detector
The glass surface is not directly heated thanks to the induction technology



Quick heating with PowerBoost



Fixes the cooking zone in boiling temperature (100 °C)



Fixes the cooking zone in frying temperature (160 °C)



Keeps the cooking zone in 50 °C



Special function for chocolate melting (40 °C)



This function locks two zones to act as a single zone for using large utensils.



Cooking duration control with Timer



Will pause all the cooking in all zones and restart it from the same power levels when pressed again. Keeps the paused zones warm.



Key lock function is for to block and to set the appliance in a safe mode during operation and cleaning.



Safe usage with Child Lock



The hob will shut off automatically if left idle for a long time. (1,5 to 6 hours depending on the power level)



Easy to clean thanks to special glass surface

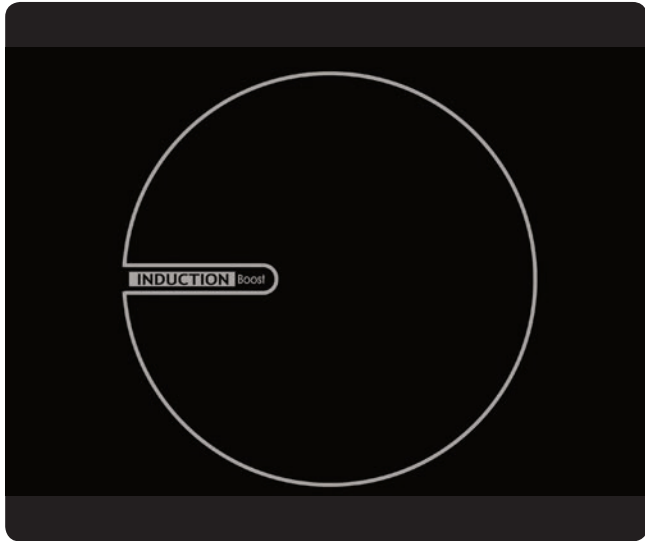

Slim Design (for induction hobs)

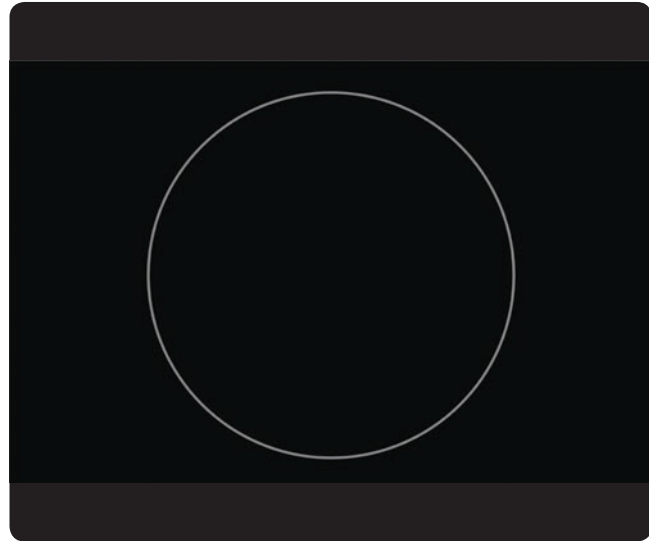

Slim Design for Vitroceramic Hobs



Line Design (for induction hobs)

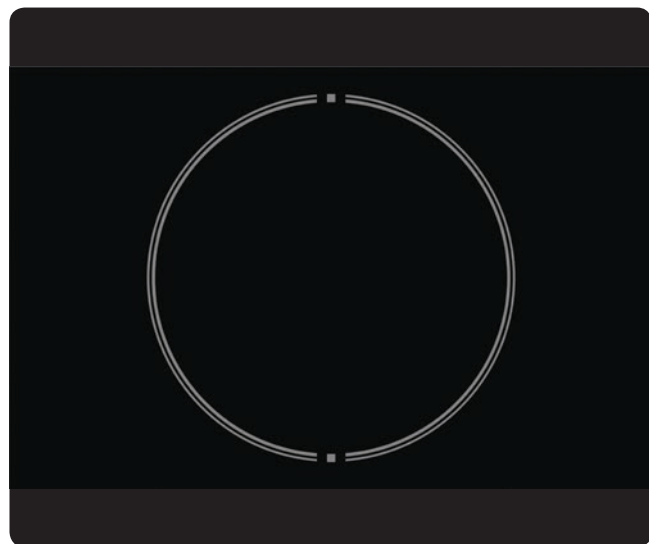

Point Design for Vitroceramic Hobs



Plus Design (for induction hobs)

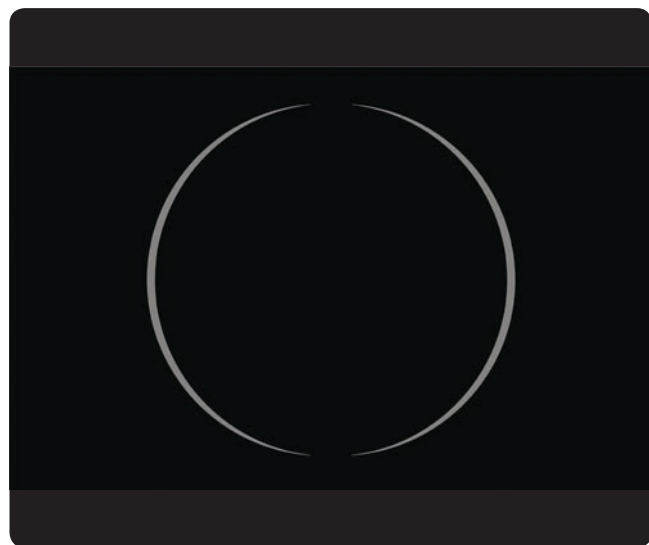

Arc Design for Vitroceramic Hobs

Touch Control Panel for 90cm induction hobs



Slider Touch Control Panel for Slim Design (induction hobs Series II)

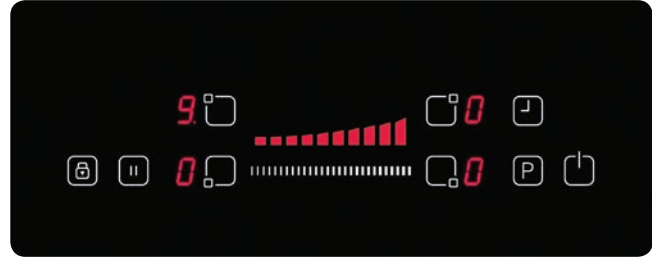

Slider Touch Control Panel for Plus and Line Design (induction hobs Series II)

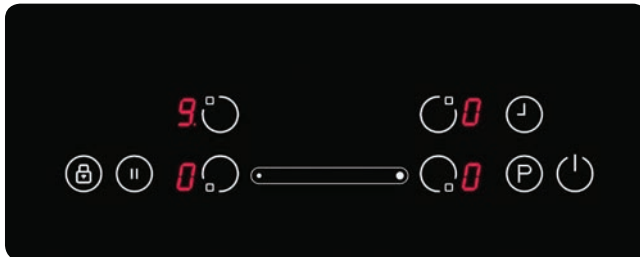

Slider Touch Control Panel for Slim Design (induction hobs Series I)

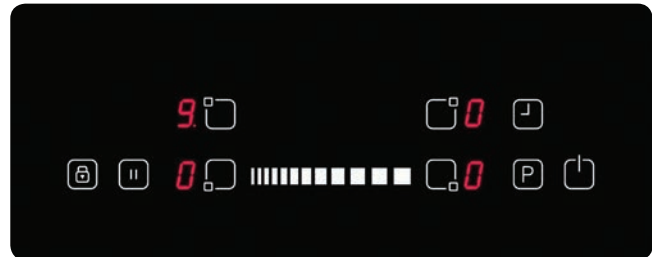

Slider Touch Control Panel for Plus and Line Design (induction hobs Series I)

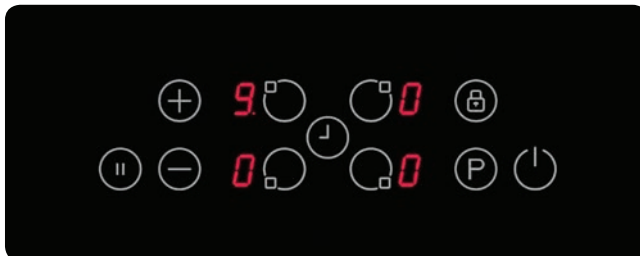

Touch Control Panel for induction hobs

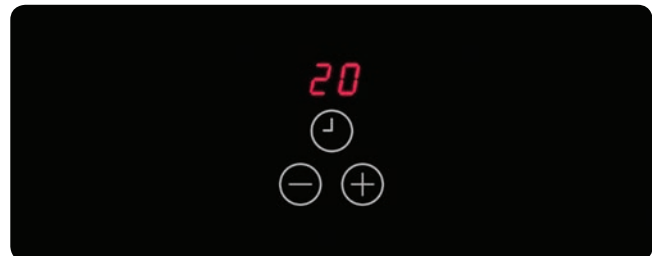

Touch Control Panel for induction poly hobs

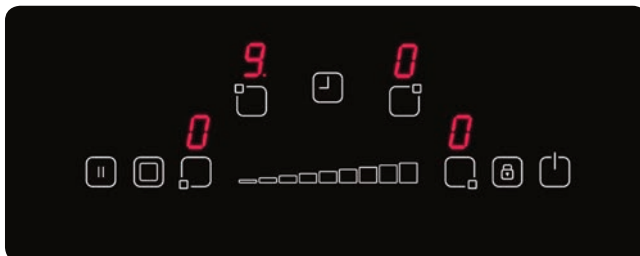

Slider Touch Control Panel (for vitro hobs)

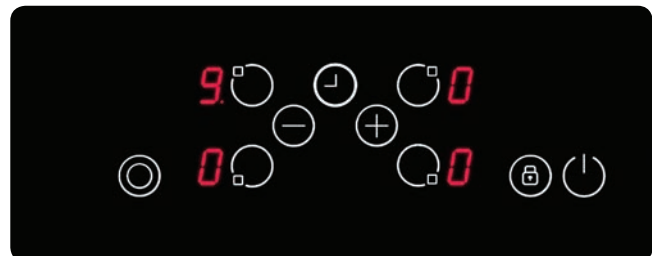

Touch Control Panel for vitroceramic hobs



Touch Control Panel for domino induction hobs

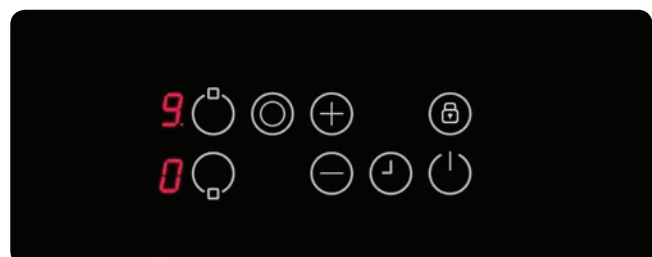

Touch Control Panel for domino vitro hobs



180 mm Dual Zone For Vitroceramic Hobs

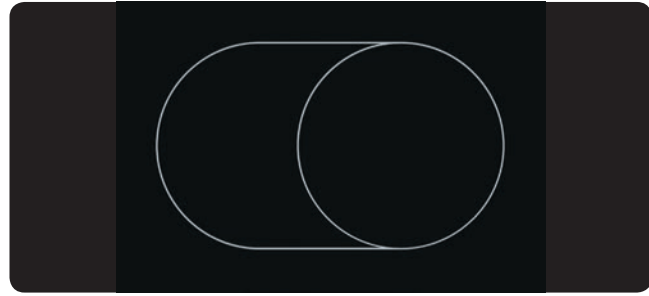

145 mm Oval Zone For Vitroceramic Hobs

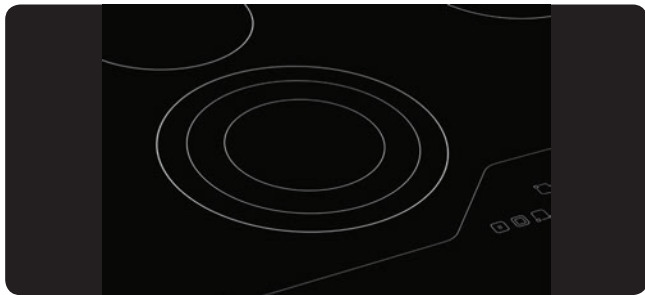

210 mm Triple Zone For Vitroceramic Hobs

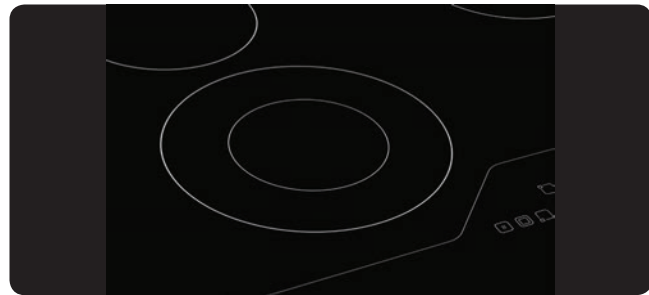

210 mm Zone Dual Zone For Vitroceramic Hobs

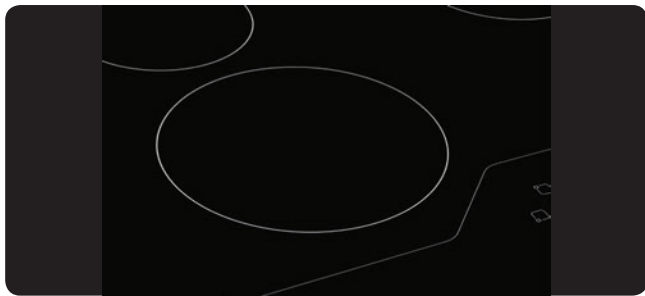

210 mm Zone For Vitroceramic Hobs

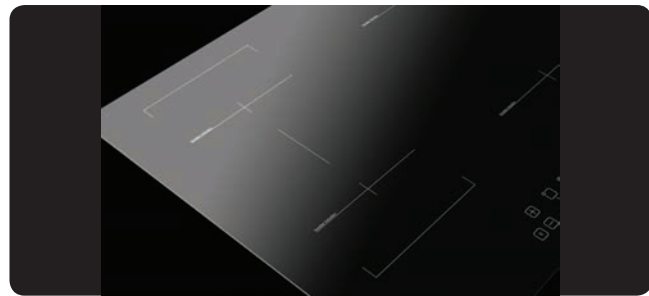

Bridge Zone

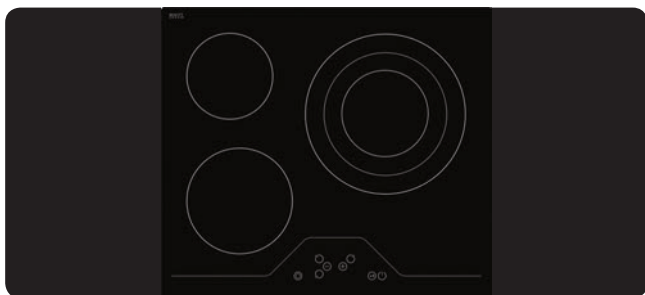

290 mm Triple Zone For Vitroceramic Hobs

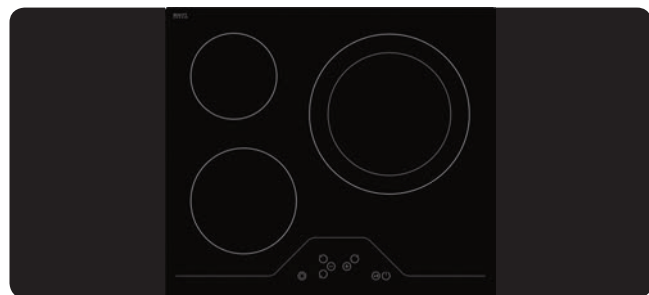

290 mm Dual Zone For Vitroceramic Hobs

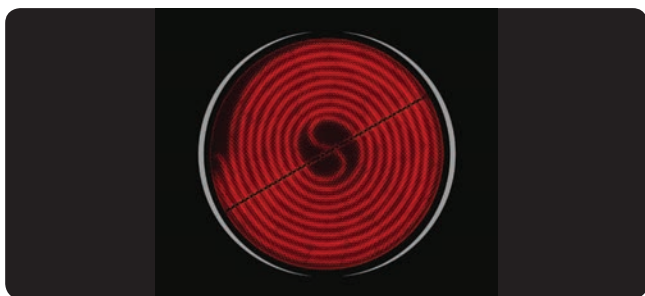

Highlight Heating Element

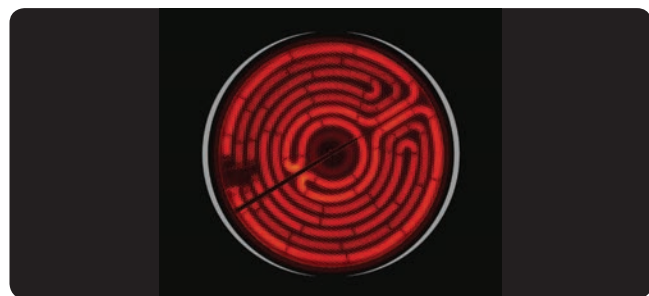

Radiant Heating Element

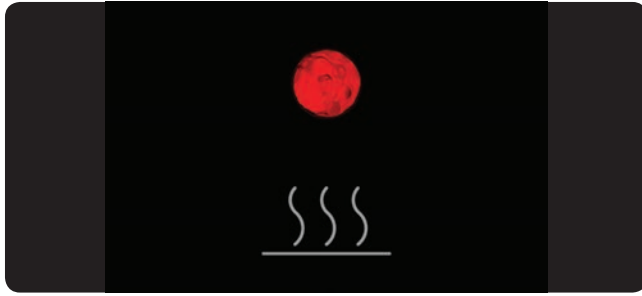

Hot Surface Indicator Light For Vitroceramic Hobs

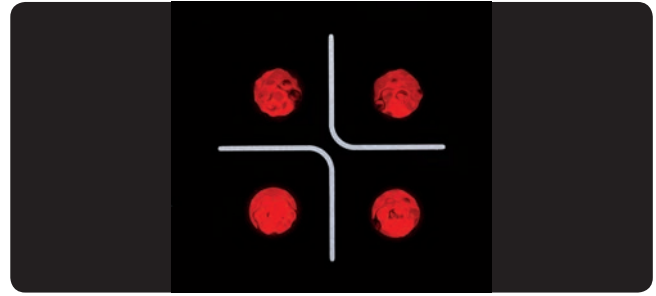

Hot Surface Indicators For Vitroceramic Hobs



Bevelled Edges For Vitroceramic Hobs

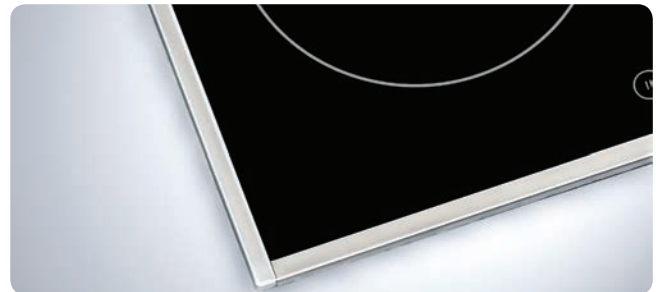

Inox Frame

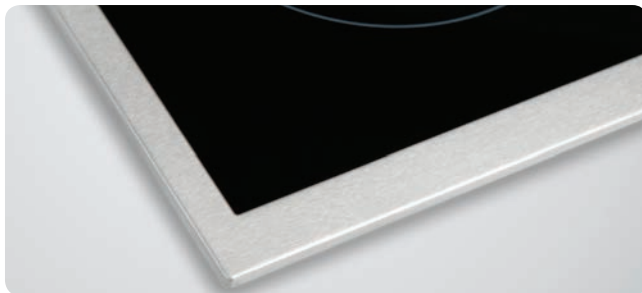

Full Inox Frame



Two Sides Inox Frame

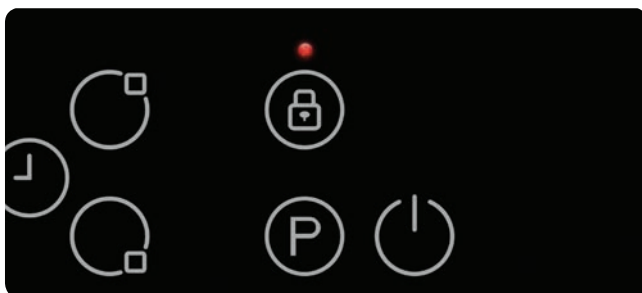

Key Lock For Induciton Hobs



Vitroceramic Glass Cleaning Spatula

GAS ON GLASS HOB PAN SUPPORT TYPES



Enamel Pan Supports (Gas On Glass Hobs)



Cast Iron Pan Supports (Gas On Glass Hobs)



Mat Enamel Pan Supports (Gas On Glass Hobs)



Profile Type Pan Supports (Gas On Glass Hobs)



Plus X Cast Iron (Gas On Glass)



Plusx Cat Iron (Gas On Glass)



Deluxe Pan Supports (Gas On Glass)



Line Pan Supports (Gas On Glass)



S-Type



V-Type



D-Type



O-Type



K-Type



W-Type



S-Type



E-Type



K-Type



Enamel Pan Supports



Mat Enamel Pan Supports



Cast Iron Pan Supports



Enamel Burner Pan And Enamel Pan Support For Gas On Glass Hobs



Mat Enamel Burner Pan And Cast Iron Pan Support For Gas On Glass Hobs



Inox Burner Pan And Mat Enamel Pan Supports For Gas On Glass Hobs



Ignition For Gas Burners



Flame Failure Device For Gas Burners



Enamel Flat Burner Caps



Enamel 3D Burner Caps



Cast Iron Burner Caps



Mat Enamel Burner Caps



Enamel Wok Adapter



Enamel Wok Adapter (Square)



Cast Iron Wok Adapter



Cast Iron Wok Adapter for High Efficiency Wok Burner (for 90cm Securit Hobs)"



Rapid Solid Hotplate



Wok Burner



Button Ignition For Gas Hobs



Mechanical Timer For Domino Hobs



Cast Iron Coffee Support



High Efficiency Wok Burner
(for 90cm Securit Hobs)



Enamel Coffee Support

HOB SPECIFICATIONS

BUILT-IN / TABLE-TOP HOB SPECIFICATION SHEET		BI Gas/Combined Hobs							
		60 CM	60 CM	60 CM	60 CM	60 CM	60 CM	70 CM	70 CM
		Flat / Surface	Extenda	Classic	Model I	PlusX	Division	Model I	PlusX
Available Colours									
White		Standard	Standard	Standard	Standard	Standard	-	Standard	Standard
Brown		Optional	Optional	Optional	Optional	Optional	-	Optional	Optional
Terre de France		Optional	Optional	Optional	Optional	Optional	-	Optional	Optional
Black		Optional	Optional	Optional	Optional	Optional	-	Optional	Optional
Dark Green		Optional	Optional	Optional	Optional	Optional	-	Optional	Optional
Stainless Steel		Optional	Optional	Optional	Optional	Optional	Standard	Optional	Optional
Product Dimensions									
Height (max., varies from model to model)	mm	40	40	40	39,5	42	42	39,5	42
Width	mm	580	580	580	590	580	580	680	700
Depth (max., do not include gas connection detail)	mm	510	510	510	515	515	510	515	515
Cut-out Dimensions									
Width	mm	560	560	560	560	560	560	560	560
Depth	mm	490	490	490	490	490	490	490	490
Hob Features									
Hob		Enamel / Stainless Steel	Enamel / Stainless Steel	Enamel / Stainless Steel	Enamel / Stainless Steel	Enamel / Stainless Steel	Stainless Steel	Enamel / Stainless Steel	Enamel / Stainless Steel
Rapid Gas Burner Ø10cm	W	3000	3000	3000	3000	3000	3000	3000	3000
Semi-rapid Gas Burner Ø7,5cm	W	1750	1750	1750	1750	1750	1750	1750	1750
Auxiliary Gas Burner Ø5,5cm	W	1000	1000	1000	1000	1000	1000	1000	1000
Wok (Triple Flame) Gas Burner Mono Ø14cm	W	3800	3800	3600	3600	-	-	3600	3600
Wok (Triple Flame) Gas Burner Dual Ø14cm	W	-	-	-	-	-	-	-	-
Wok (Triple Flame) Gas Burner Ø11cm	W	-	-	-	-	3200	-	-	-
Ø 145 mm Hotplate	W	-	-	1000	1000	1000	-	1000	1000
Ø 180 mm Hotplate	W	1500	1500	-	-	-	-	-	-
Ø 145 mm Rapid Hotplate	W	-	-	-	-	-	-	-	-
Ø 180 mm Rapid Hotplate	W	-	-	-	-	-	-	-	-
Ø145 mm Highlite Element	W	-	-	-	-	-	-	-	-
Ø180 mm Highlite Element	W	-	-	-	-	-	-	-	-
Ø210 mm Highlite Element	W	-	-	-	-	-	-	-	-
Ø180 mm Dual Highlite Element	W	-	-	-	-	-	-	-	-
Ø145 mm Oval Highlite Element	W	-	-	-	-	-	-	-	-
Ø210 mm Dual Highlite Element	W	-	-	-	-	-	-	-	-
Ø210 mm Triple Highlite Element	W	-	-	-	-	-	-	-	-
Ø290 mm Dual/Triple Highlite Element	W	-	-	-	-	-	-	-	-
Ø 160 mm Induction Zone(Serie 1 and Serie 2)	W	-	-	-	-	-	-	-	-
Ø 200 mm Induction Zone(Serie 1)	W	-	-	-	-	-	-	-	-
Ø 210 mm Induction Zone(Serie 2)	W	-	-	-	-	-	-	-	-
Ø 250 mm Induction Zone(Serie 1)	W	-	-	-	-	-	-	-	-
Ø 290 mm Induction Zone(Serie 2)	W	-	-	-	-	-	-	-	-
Boost Function		-	-	-	-	-	-	-	-
Pot Dedection		-	-	-	-	-	-	-	-
Automatic Heatup		-	-	-	-	-	-	-	-
Timer function for vitro ceramic hobs (If touch control with some hob configuration selected)		-	-	-	-	-	-	-	-
Mode function for induction ceramic hobs (If touch control with some hob configuration selected)		-	-	-	-	-	-	-	-
Bridge zone for induction ceramic hobs (If touch control with some hob configuration selected)		-	-	-	-	-	-	-	-
Child Lock for vitro ceramic hobs (If touch control selected)		-	-	-	-	-	-	-	-
Mechanical Child Lock (Main Switch)		-	-	-	-	-	-	-	-
Hot Surface Indicator Light		-	-	-	-	-	-	-	-
Hotplate Operation Indicator Light		Standard	Standard	Standard	Standard	Standard	-	Standard	Standard
Side Knob Control		Standard	Standard	Standard	-	-	-	-	-
Side Touch Control		-	-	-	-	-	-	-	-
Front Knob Control		-	-	-	Standard	Standard	-	Standard	Standard
Double Side Front Control		-	-	-	-	-	Standard	-	-
Front Triangular Touch Control		-	-	-	-	-	-	-	-
Front Slider Touch Control		-	-	-	-	-	-	-	-
Front Touch Control		-	-	-	-	-	-	-	-
Bevelled Edges		-	-	-	-	-	-	-	-
Logo		Standard	Standard	Standard	Standard	Standard	Standard	Standard	Standard
Special Decoration on Glass		-	-	-	-	-	-	-	-
Vitroceramic Glass Artwork		-	-	-	-	-	-	-	-
Inox Frame		-	-	-	-	-	-	-	-
Stainless Steel Burner Pan		-	-	-	-	-	-	-	-
Table Top Installation (not built-in)		Optional	Optional	Optional	-	-	-	-	-
Glass Lid		-	-	-	-	-	-	-	-
Burner Safety Valves		Standard	Standard	Standard	Standard	Standard	Standard	Standard	Standard
Button Ignition		Optional	Optional	Optional	Optional	-	-	Optional	-
One-touch-Ignition through knobs		Optional	Optional	Optional	Optional	Optional	Standard	Optional	Optional
Enamel Pan Supports		Standard	Standard	Standard	Standard	Standard	-	Standard	Standard
Cast Iron Pan Supports		Optional	Optional	-	Optional	Optional	Standard	Optional	Optional
Cast Iron Burner Caps		Optional	Optional	-	Optional	Optional	Optional	Optional	Optional
Coffee Adaptor		Optional	Optional	Optional	Optional	Optional	Optional	Optional	Optional
Wok Adaptor		Optional	Optional	Optional	Optional	Optional	-	Optional	Optional
Vitroceramic Glass Cleaning Spatula		-	-	-	-	-	-	-	-
Gas Conversion Kit		Standard	Standard	Standard	Standard	Standard	Standard	Standard	Standard
Others									
Total Gas Power (Depends on Model) Maximum	kW	8,3	8,3	8,1	8,1	7,7	7,5	11,1	11,1
Total Electric Power (Depends on Model) Maximum	kW	1,5	1,5	1	1	1	-	1	1
Voltage	V	230V~	230V~	230V~	230V~	230V~	230V~	230V~	230V~
RoHS Compliance		Standard	Standard	Standard	Standard	Standard	Standard	Standard	Standard
CE Compliance		Standard	Standard	Standard	Standard	Standard	Standard	Standard	Standard
Carton Box Packaging		Standard	Standard	Standard	Standard	Standard	Standard	Standard	Standard
Packed Product Dimensions (WxDxH)	mm	626 x 580 x 140	x	626 x 560 x 130	641 x 576 x 161	x	x	731 x 576 x 161	x
Packed Product Dimensions (WxDxH) Box	mm	640 x 584 x 152	647 x 582 x 164	635 x 564 x 142	x	647 x 582 x 164	647 x 582 x 164	x	769 x 582 x 164
Net Weight (Depends on Model) Maximum	kg	9	9,5	6,6	9,8	9,5	11	10,7	12,5
Gross Weight (Depends on Model) Maximum	kg	9,75	10,5	7,5	10,6	10,5	12	11,6	13,5

HOB SPECIFICATIONS

BUILT-IN / TABLE-TOP HOB SPECIFICATION SHEET	BI Gas Securit Hobs								
		60 CM	60 CM	60 CM	60 CM	60 CM	70 CM	70 CM	90 CM
		Securit II	Trio	Model I	PlusX	Division	Model I	PlusX	
Available Colours									
White		Optional	Optional	Optional	Optional	-	Optional	Optional	Optional
Brown		Optional	Optional	Optional	Optional	-	Optional	Optional	Optional
Terre de France		Optional	Optional	Optional	Optional	-	Optional	Optional	Optional
Black		Standard	Standard	Standard	Standard	Standard	Standard	Standard	Standard
Dark Green		Optional	Optional	Optional	Optional	-	Optional	Optional	Optional
Stainless Steel		-	-	-	-	-	-	-	-
Product Dimensions									
Height (max., varies from model to model)	mm	44	44	39,5	44	44	39,5	44	47
Width	mm	594	594	590	594	594	680	700	882
Depth (max., do not include gas connection detail)	mm	523	523	515	523	523	515	520	520
Cut-out Dimensions									
Width	mm	560	560	560	560	560	560	560	850
Depth	mm	490	490	490	490	490	490	490	480
Hob Features									
Hob		Securit	Securit	Securit	Securit	Securit	Securit	Securit	Securit
Rapid Gas Burner Ø10cm	W	3000	3000	3000	3000	3000	3000	3000	3000
Semi-rapid Gas Burner Ø7.5cm	W	1750	1750	1750	1750	1750	1750	1750	1750
Auxiliary Gas Burner Ø5.5cm	W	1000	1000	1000	1000	1000	1000	1000	1000
Wok (Triple Flame) Gas Burner Mono Ø14cm	W	3800	3600	3800	3600	-	3800	3600	4500
Wok (Triple Flame) Gas Burner Dual Ø14cm	W	-	-	-	-	-	-	-	4500
Wok (Triple Flame) Gas Burner Ø11cm	W	-	-	-	-	-	-	-	-
Ø 145 mm Hotplate	W	-	-	-	1000	-	-	-	-
Ø 180 mm Hotplate	W	-	-	-	-	-	-	-	-
Ø 145 mm Rapid Hotplate	W	-	-	-	-	-	-	-	-
Ø 180 mm Rapid Hotplate	W	-	-	-	-	-	-	-	-
Ø145 mm Highlite Element	W	-	-	-	-	-	-	-	-
Ø180 mm Highlite Element	W	-	-	-	-	-	-	-	-
Ø210 mm Highlite Element	W	-	-	-	-	-	-	-	-
Ø180 mm Dual Highlite Element	W	-	-	-	-	-	-	-	-
Ø145 mm Oval Highlite Element	W	-	-	-	-	-	-	-	-
Ø210 mm Dual Highlite Element	W	-	-	-	-	-	-	-	-
Ø210 mm Triple Highlite Element	W	-	-	-	-	-	-	-	-
Ø290 mm Dual/Triple Highlite Element	W	-	-	-	-	-	-	-	-
Ø 160 mm Induction Zone(Serie 1 and Serie 2)	W	-	-	-	-	-	-	-	-
Ø 200 mm Induction Zone(Serie 1)	W	-	-	-	-	-	-	-	-
Ø 210 mm Induction Zone(Serie 2)	W	-	-	-	-	-	-	-	-
Ø 250 mm Induction Zone(Serie 1)	W	-	-	-	-	-	-	-	-
Ø 290 mm Induction Zone(Serie 2)	W	-	-	-	-	-	-	-	-
Boost Function		-	-	-	-	-	-	-	-
Pot Dedection		-	-	-	-	-	-	-	-
Automatic Heatup		-	-	-	-	-	-	-	-
Timer function for vitro ceramic hobs (If touch control with some hob configuration selected)		-	-	-	-	-	-	-	-
Mode function for induction ceramic hobs (If touch control with some hob configuration selected)		-	-	-	-	-	-	-	-
Bridge zone for induction ceramic hobs (If touch control with some hob configuration selected)		-	-	-	-	-	-	-	-
Child Lock for vitro ceramic hobs (If touch control selected)		-	-	-	-	-	-	-	-
Mechanical Child Lock (Main Switch)		-	-	-	-	-	-	-	Optional
Hot Surface Indicator Light		-	-	-	-	-	-	-	-
Hotplate Operation Indicator Light		-	-	Standard	Standard	-	-	-	-
Side Knob Control		Standard	Standard	-	-	-	-	-	-
Side Touch Control		-	-	-	-	-	-	-	-
Front Knob Control		-	-	Standard	Standard	-	Standard	Standard	Standard
Double Side Front Control		-	-	-	-	Standard	-	-	-
Front Triangular Touch Control		-	-	-	-	-	-	-	-
Front Slider Touch Control		-	-	-	-	-	-	-	-
Front Touch Control		-	-	-	-	-	-	-	-
Bevelled Edges		-	-	-	-	-	-	-	Optional
Logo		Optional	Optional	Standard	Standard	Standard	Standard	Standard	Standard
Special Decoration on Glass		Optional	Optional	-	-	-	-	-	-
Vitroceramic Glass Artwork		-	-	-	-	-	-	-	-
Inox Frame		-	-	Standard	-	-	Standard	-	Optional
Stainless Steel Burner Pan		Optional	Optional	Optional	Optional	-	Optional	Optional	Optional
Table Top Installation (not built-in)		-	-	-	-	-	-	-	-
Glass Lid		-	-	-	-	-	-	-	-
Burner Safety Valves		Standard	Standard	Standard	Standard	Standard	Standard	Standard	Standard
Button Ignition		Optional	Optional	Optional	-	-	Optional	-	-
One-touch-Ignition through knobs		Optional	Optional	Optional	Optional	Standard	Optional	Optional	Standard
Enamel Pan Supports		Standard	Standard	Standard	Standard	-	Standard	Standard	-
Cast Iron Pan Supports		Optional	Optional	Optional	Optional	Standard	Optional	Optional	Standard
Cast Iron Burner Caps		Optional	Optional	Optional	Optional	Optional	Optional	Optional	Standard
Coffee Adaptor		Optional	Optional	Optional	Optional	Optional	Optional	Optional	Optional
Wok Adaptor		Optional	Optional	Optional	Optional	-	Optional	Optional	Optional
Vitroceramic Glass Cleaning Spatula		-	-	-	-	-	-	-	-
Gas Conversion Kit		Standard	Standard	Standard	Standard	Standard	Standard	Standard	Optional
Others									
Total Gas Power (Depends on Model) Maximum	kW	8,3	8,1	8,3	8,1	7,5	11,3	11,1	12
Total Electric Power (Depends on Model) Maximum	kW	-	-	-	1	-	-	-	-
Voltage	V	230V~	230V~	230V~	230V~	230V~	230V~	230V~	230V~
RoHS Compliance		Standard	Standard	Standard	Standard	Standard	Standard	Standard	Standard
CE Compliance		Standard	Standard	Standard	Standard	Standard	Standard	Standard	Standard
Carton Box Packaging		Standard	Standard	Standard	Standard	Standard	Standard	Standard	Standard
Packed Product Dimensions (WxDxH)	mm	622 x 580 x 140	622 x 580 x 140	641 x 576 x 161	x	x	731 x 576 x 161	x	x
Packed Product Dimensions (WxDxH) Box	mm	x	x	x	647 x 582 x 164	647 x 582 x 164	x	769 x 582 x 164	935 x 582 x 164
Net Weight (Depends on Model) Maximum	kg	9,5	9,5	10,7	11,5	-	13,7	13,8	20,5
Gross Weight (Depends on Model) Maximum	kg	10,25	10,25	11,13	12,5	-	14,2	14,8	21,5

HOB SPECIFICATIONS

BUILT-IN / TABLE-TOP HOB SPECIFICATION SHEET	BI Electric Hobs		BI Vitro Ceramic Hobs		BI Induction Ceramic Hobs		
	60 CM	60 CM	78 CM	60 CM	78 CM	90CM	
	Flat / Surface	C Serie	C Serie	Vestel Induction	Vestel Induction	Vestel Induction	
Available Colours							
White	Standard	Optional	Optional	Optional	Optional	Optional	
Brown	Optional	-	-	-	-	-	
Terre de France	Optional	-	-	-	-	-	
Black	Optional	Standard	Standard	Standard	Standard	Standard	
Dark Green	Optional	-	-	-	-	-	
Stainless Steel	Optional	-	-	-	-	-	
Product Dimensions							
Height (max.,varies from model to model)	mm	40	41 - 47,5	41	56	56	56
Width	mm	580	590	780	590	590	890
Depth (max., do not include gas connection detail)	mm	510	520	520	520	520	520
Cut-out Dimensions							
Width	mm	560	560	750	560	750	860
Depth	mm	490	490	490	490	490	490
Hob Features							
Hob		Enamel / Stainless Steel	Vitro Ceramic	Vitro Ceramic	Induction Ceramic	Induction Ceramic	Induction Ceramic
Rapid Gas Burner Ø10cm	W	-	-	-	-	-	-
Semi-rapid Gas Burner Ø7.5cm	W	-	-	-	-	-	-
Auxiliary Gas Burner Ø5.5cm	W	-	-	-	-	-	-
Wok (Triple Flame) Gas Burner Mono Ø14cm	W	-	-	-	-	-	-
Wok (Triple Flame) Gas Burner Dual Ø14cm	W	-	-	-	-	-	-
Wok (Triple Flame) Gas Burner Ø11cm	W	-	-	-	-	-	-
Ø 145 mm Hotplate	W	1000	-	-	-	-	-
Ø 180 mm Hotplate	W	1500	-	-	-	-	-
Ø 145 mm Rapid Hotplate	W	1500	-	-	-	-	-
Ø 180 mm Rapid Hotplate	W	2000	-	-	-	-	-
Ø145 mm Highlite Element	W	-	1200	1200	-	-	-
Ø180 mm Highlite Element	W	-	1800	1800	-	-	-
Ø210 mm Highlite Element	W	-	2300	2300	-	-	-
Ø180 mm Dual Highlite Element	W	-	1700	1700	-	-	-
Ø145 mm Oval Highlite Element	W	-	1800	1800	-	-	-
Ø210 mm Dual Highlite Element	W	-	2200	2200	-	-	-
Ø210 mm Triple Highlite Element	W	-	2300	2300	-	-	-
Ø290 mm Dual/Triple Highlite Element	W	-	2700	-	-	-	-
Ø 160 mm Induction Zone(Serie 1 and Serie 2)	W	-	-	-	Nominal 1400 W max. Boost 1800 W	Nominal 1400 W max. Boost 1800 W	Nominal 1400 W max. Boost 1800 W
Ø 200 mm Induction Zone(Serie 1)	W	-	-	-	Nominal 2100 W max. Boost 2500 W	Nominal 2100 W max. Boost 2500 W	Nominal 2100 W max. Boost 2500 W
Ø 210 mm Induction Zone(Serie 2)	W	-	-	-	Nominal 2100 W max. Boost 2500 W	-	-
Ø 250 mm Induction Zone(Serie 1)	W	-	-	-	Nominal 2800 W max. Boost 3500 W	Nominal 2800 W max. Boost 3500 W	Nominal 2800 W max. Boost 3500 W
Ø 290 mm Induction Zone(Serie 2)	W	-	-	-	Nominal 2800 W max. Boost 3500 W	-	-
Boost Function					Standard	Standard	Standard
Pot Dedection					Standard	Standard	Standard
Automatic Heatup					-	-	-
Timer function for vitro ceramic hobs (If touch control with some hob configuration selected)			Optional	Optional	Optional	Optional	Standard
Mode function for induction ceramic hobs (If touch control with some hob configuration selected)			-	-	Optional	Optional	-
Bridge zone for induction ceramic hobs (If touch control with some hob configuration selected)			-	-	Optional	-	-
Child Lock for vitro ceramic hobs (If touch control selected)			Standard	Standard	Standard	Standard	Standard
Mechanical Child Lock (Main Switch)			-	-	-	-	-
Hot Surface Indicator Light			Standard	Standard	Standard	Standard	Standard
Hotplate Operation Indicator Light		Standard	-	-	-	-	-
Side Knob Control		Standard	Standard	-	-	-	-
Side Touch Control		-	Optional	-	-	-	-
Front Knob Control		-	-	-	-	-	-
Double Side Front Control		-	-	-	-	-	-
Front Triangular Touch Control		-	Optional	Standard	-	-	-
Front Slider Touch Control		-	Optional	Optional	Optional	Optional	-
Front Touch Control		-	-	-	Optional	Optional	Optional
Bevelled Edges		-	Optional	Optional	Optional	Optional	Optional
Logo		Standard	Optional	Optional	Optional	Optional	Optional
Special Decoration on Glass		-	Optional	Optional	Optional	Optional	Optional
Vitroceraamic Glass Artwork		-	Slim / Arc / Point	Slim / Arc / Point	Slim / Plus / Line	Slim / Plus / Line	Slim / Plus / Line
Inox Frame		-	Optional	-	Optional	Optional	Optional
Stainless Steel Burner Pan		-	-	-	-	-	-
Table Top Installation (not built-in)		-	-	-	-	-	-
Glass Lid		-	-	-	-	-	-
Burner Safety Valves		-	-	-	-	-	-
Button Ignition		-	-	-	-	-	-
One-touch-Ignition through knobs		-	-	-	-	-	-
Enamel Pan Supports		-	-	-	-	-	-
Cast Iron Pan Supports		-	-	-	-	-	-
Cast Iron Burner Caps		-	-	-	-	-	-
Coffee Adaptor		-	-	-	-	-	-
Wok Adaptor		-	-	-	-	-	-
Vitroceraamic Glass Cleaning Spatula		-	Optional	Optional	Optional	Optional	Optional
Gas Conversion Kit		-	-	-	-	-	-
Others							
Total Gas Power (Depends on Model) Maximum	kW	-	-	-	-	-	-
Total Electric Power (Depends on Model) Maximum	kW	6	6,5	8,3	7,4	7,4	10,8
Voltage	V	230V~ / 400V 2N~	230V~ / 400V 3N~	230V~ / 400V 3N~	230V~ / 400V 3N~	230V~ / 400V 3N~	230V~ / 400V 3N~
RoHS Compliance		Standard	Standard	Standard	Standard	Standard	Standard
CE Compliance		Standard	Standard	Standard	Standard	Standard	Standard
Carton Box Packaging		Standard	Standard	Standard	Standard	Standard	Standard
Packed Product Dimensions (WxDxH)	mm	626 x 580 x 140	620 x 578 x 133	810 x 578 x 133	626 x 581 x 142	816 x 581 x 142	926 x 581 x 142
Packed Product Dimensions (WxDxH) Box	mm	640 x 584 x 152	631 x 580 x 143	x	643 x 583 x 152	x	941 x 583 x 152
Net Weight (Depends on Model) Maximum	kg	9,5	9,5	10,15	11	12	16
Gross Weight (Depends on Model) Maximum	kg	10,25	10,25	11	12	13	17



VIFTC.16

STANDARD FEATURES

90 cm induction ceramic hob
 Front touch control
 Booster function
 2 Ø 160 mm 1400 W / Boost
 1800 W induction element
 2 Ø 200 mm 2100 W / Boost
 2500 W induction element
 1 Ø 250 mm 2800 W / Boost
 3500 W induction element
 Pot detection
 Child lock

Hot surface indicator
 Timer
 Slim design ceran glass
 serigraphy
 Key Lock
 Smart Pause

OPTIONAL FEATURES

Two side inox frame

VIFTC.01

STANDARD FEATURES

78 cm induction ceramic
 hob
 Booster function
 2 Ø 160 mm 1400 W /
 Boost 1800 W induction
 element
 2 Ø 200 mm 2100 W /
 Boost 2500 W induction
 element
 Pot detection
 Key lock

Child lock
 Hot surface indicator
 Smart Pause

OPTIONAL FEATURES

Slider touch control
 Timer
 Two side inox frame
 Front side bevelled
 edge glass
 Mode function

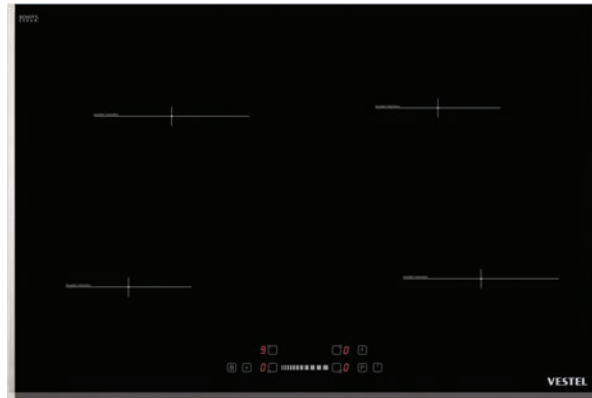

VIFTC.02

STANDARD FEATURES

78 cm induction ceramic
 hob
 Booster function
 2 Ø 160 mm 1400 W /
 Boost 1800 W induction
 element
 2 Ø 200 mm 2100 W /
 Boost 2500 W induction
 element
 Pot detection
 Key lock

Child lock
 Hot surface indicator
 Smart Pause

OPTIONAL FEATURES

Slider touch control
 Timer
 Bevelled edge glass
 Mode function



VIFTC.04

STANDARD FEATURES

78 cm induction ceramic hob
 Front touch control
 Booster function
 2 Ø 160 mm 1400 W /
 Boost 1800 W induction element
 2 Ø 200 mm 2100 W /
 Boost 2500 W induction element
 Pot detection

Key lock
 Child lock
 Hot surface indicator
 Smart Pause

OPTIONAL FEATURES

Timer
 Two side inox frame
 Front and back side bevelled edge glass
 Mode function

VIFTC.05

STANDARD FEATURES

78 cm induction ceramic hob
 Front touch control
 Booster function
 2 Ø 160 mm 1400 W /
 Boost 1800 W induction element
 2 Ø 200 mm 2100 W /
 Boost 2500 W induction element
 Pot detection

Key lock
 Child lock
 Hot surface indicator
 Smart Pause

OPTIONAL FEATURES

Timer
 Bevelled edge glass

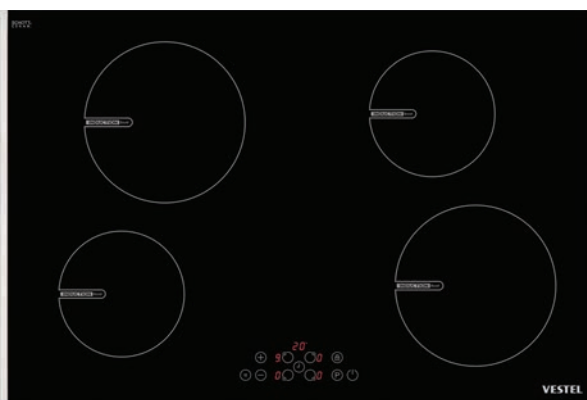
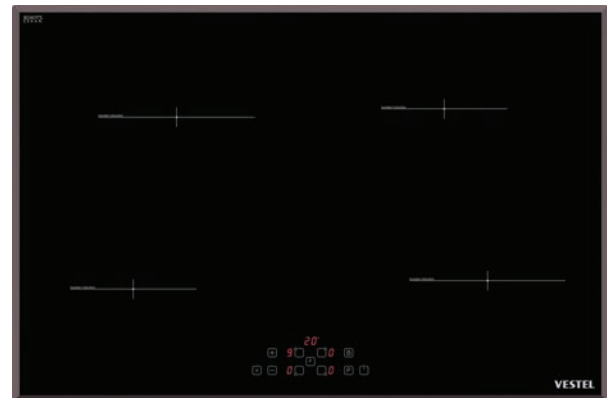

VIFTC.06

STANDARD FEATURES

78 cm induction ceramic hob
 Front touch control
 Booster function
 2 Ø 160 mm 1400 W /
 Boost 1800 W induction element
 2 Ø 200 mm 2100 W /
 Boost 2500 W induction element
 Pot detection

Key lock
 Child lock
 Hot surface indicator
 Smart Pause

OPTIONAL FEATURES

Timer
 Two side inox frame
 Mode function

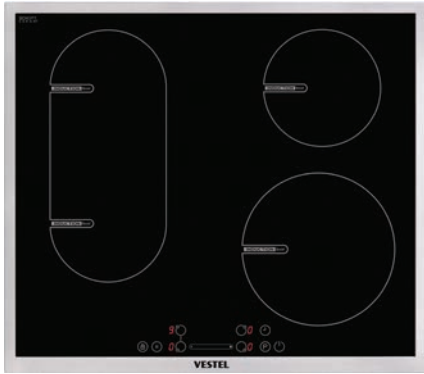

VIFTC.18

STANDARD FEATURES

60 cm induction ceramic hob
 Booster function
 3 Ø 160 mm 1400 W / Boost 1800 W induction element
 1 Ø 210 mm 2100 W / Boost 2500 W induction element
 Pot Detection
 Child lock
 Hot surface indicator
 Key lock
 Smart pause

OPTIONAL FEATURES

Slider touch control
 Timer
 Full inox frame
 Line design
 Ceran glass serigraphy
 Birdge zone
 Mode function

VIFTC.08

STANDARD FEATURES

60 cm induction ceramic hob
 Booster function
 2 Ø 160 mm 1400 W / Boost 1800 W induction element
 2 Ø 210 mm 2100 W / Boost 2500 W induction element
 Pot detection
 Key lock
 Child lock
 Hot surface indicator
 Smart Pause

OPTIONAL FEATURES

Slider touch control
 Timer
 Two side inox frame
 Front and back side bevelled edge glass
 Mode function

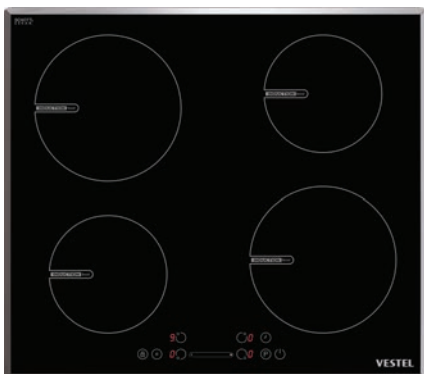
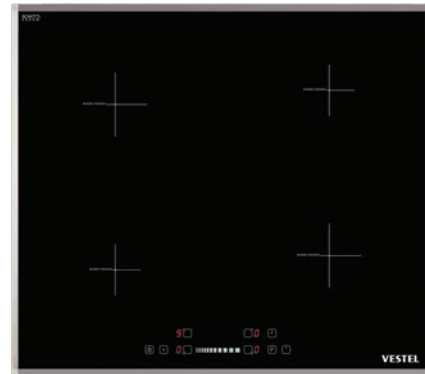

VIFTC.09

STANDARD FEATURES

60 cm induction ceramic hob
 Booster function
 2 Ø 160 mm 1400 W / Boost 1800 W induction element
 2 Ø 210 mm 2100 W / Boost 2500 W induction element
 Pot detection
 Key lock
 Child lock
 Hot surface indicator
 Smart Pause

OPTIONAL FEATURES

Slider touch control
 Timer
 Bevelled edge glass
 Mode function

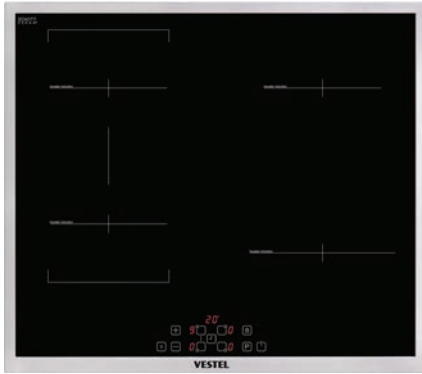

VIFTC.17

STANDARD FEATURES

60 cm induction ceramic hob
 Front touch control
 Booster function
 3 Ø 160 mm 1400 W / Boost 1800 W
 induction element
 1 Ø 210 mm 2100 W / Boost 2500 W
 induction element
 Pot Detection
 Child lock
 Hot surface indicator
 Key lock
 Smart pause

OPTIONAL FEATURES

Timer
 Full inox frame
 Line design ceran glass serigraphy
 Bridge Zone
 Mode function

VIFTC.10

STANDARD FEATURES

60 cm induction ceramic hob
 Booster function
 1 Ø 160 mm 1400 W / Boost 1800 W
 induction element
 1 Ø 210 mm 2100 W / Boost 2500 W
 induction element
 1 Ø 290 mm 2800 W / Boost 3500 W
 induction element
 Pot detection
 Key lock
 Child lock

Hot surface indicator
 Smart Pause

OPTIONAL FEATURES

Slider touch control
 Timer

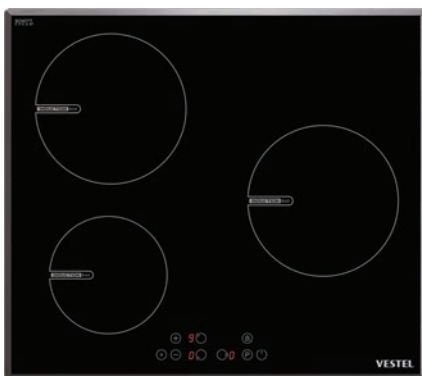
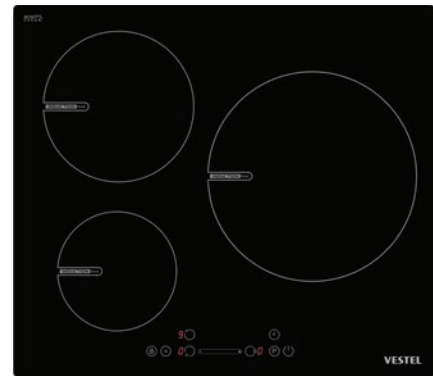

VIFTC.14

STANDARD FEATURES

60 cm induction ceramic hob
 Front touch control
 Booster function
 1 Ø 160 mm 1400 W / Boost 1800 W
 induction element
 2 Ø 210 mm 2100 W / Boost 2500 W
 induction element
 Pot detection
 Key lock
 Child lock

Hot surface indicator
 Smart Pause

OPTIONAL FEATURES

Bevelled edge glass

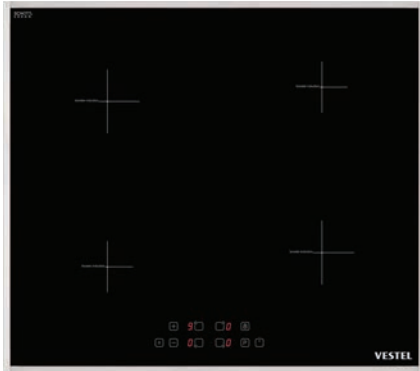

VIFTC.12

STANDARD FEATURES

60 cm induction ceramic hob
 Front touch control
 Booster function
 2 Ø 160 mm 1400 W / Boost 1800 W
 induction element
 2 Ø 210 mm 2100 W / Boost 2500 W
 induction element
 Pot detection
 Key lock
 Child lock
 Hot surface indicator
 Smart Pause

OPTIONAL FEATURES

Inox frame

VIFTC.13

STANDARD FEATURES

60 cm induction ceramic hob
 Front touch control
 Booster function
 2 Ø 160 mm 1400 W / Boost 1800 W
 induction element
 2 Ø 210 mm 2100 W / Boost 2500 W
 induction element
 Pot detection
 Key lock
 Child lock
 Hot surface indicator
 Smart Pause

OPTIONAL FEATURES

Timer
 Mode function

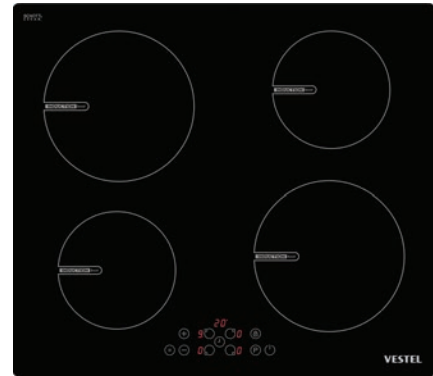

VIFTC.15

STANDARD FEATURES

60 cm induction ceramic hob
 Front touch control
 Booster function
 1 Ø 160 mm 1400 W / Boost 1800 W
 induction element
 2 Ø 210 mm 2100 W / Boost 2500 W
 induction element
 Pot detection
 Key lock
 Child lock

Hot surface indicator
 Smart Pause

OPTIONAL FEATURES

Timer
 Two side inox frame

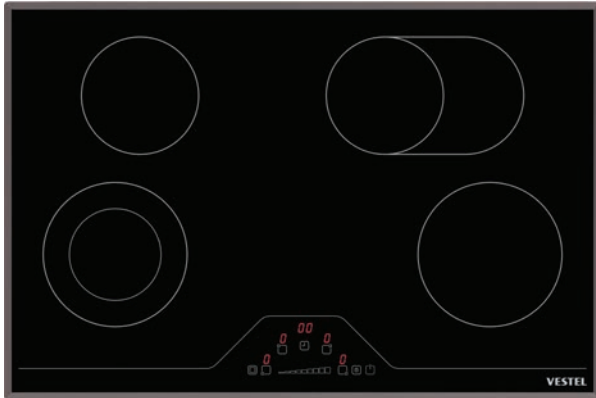

VFTC.01

STANDARD FEATURES

78 cm ceramic hob
 1 Ø 145 mm Highlite
 Element 1200W
 1 Ø 180 mm Highlite
 Element 1800W
 Child lock
 Hot surface indicator
 Key Lock
 Smart pause (with slider)

OPTIONAL FEATURES

Slider touch control
 Ø 145 mm Oval Highlite
 Element 1000W/1800W
 Ø 180 mm Dual Highlite
 Element 700W/1700W
 Timer
 Bevelled edge glass

VFTC.03

STANDARD FEATURES

78 cm ceramic hob
 Front touch control
 2 Ø 145 mm Highlite
 Element 1200W
 Child lock
 Hot surface indicator
 Key Lock

OPTIONAL FEATURES

Ø 145 mm Oval Highlite
 Element 1000W/1800W
 Ø 210 mm Highlite Element
 2300W

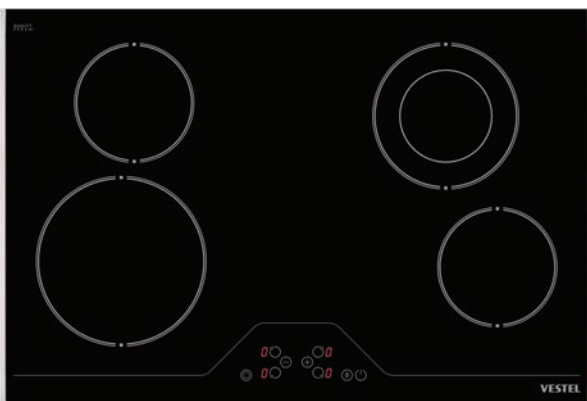
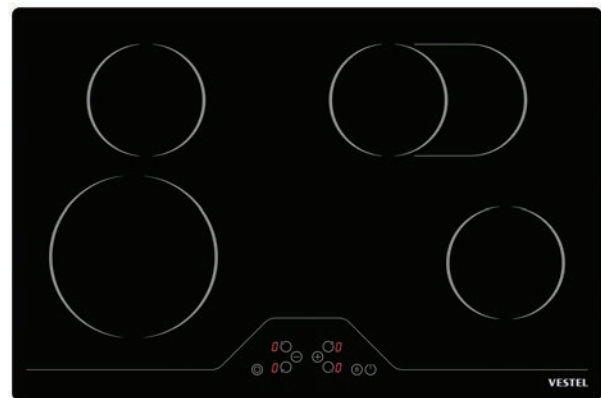

VFTC.13

STANDARD FEATURES

78 cm ceramic hob
 Front touch control
 2 Ø 145 mm Highlite
 Element 1200W
 Child Lock
 Hot surface indicator
 Key lock

OPTIONAL FEATURES

1 Ø 210 mm Highlite
 Element 2300W
 1 Ø 180mm Dual Highlite
 Element 700W/1700W
 Two side inox frame

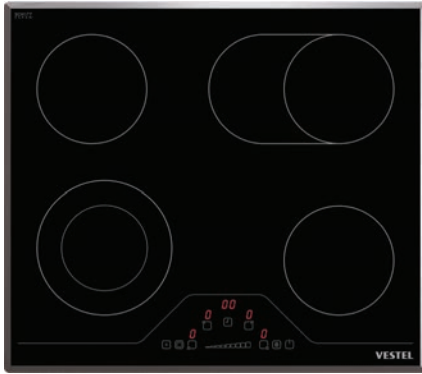

VFTC.04

STANDARD FEATURES

60 cm ceramic hob
 2 Ø 145 mm Highlite Element 1200W
 Child lock
 Hot surface indicator
 Key Lock
 Smart pause (with slider)

OPTIONAL FEATURES

Slider touch control
 Ø 180 mm Dual Highlite Element
 700W/1700W
 Ø 145 mm Oval Highlite Element
 1000W/1800W
 Timer
 Bevelled edge glass

VFTC.05

STANDARD FEATURES

60 cm ceramic hob
 2 Ø 145 mm Highlite Element 1200W
 Child lock
 Hot surface indicator
 Key Lock

OPTIONAL FEATURES

Ø 180 mm Dual Highlite Element
 700W/1700W
 Ø 210 mm Triple Highlite Element
 800W/1600W/2300W
 Timer
 Two side inox frame

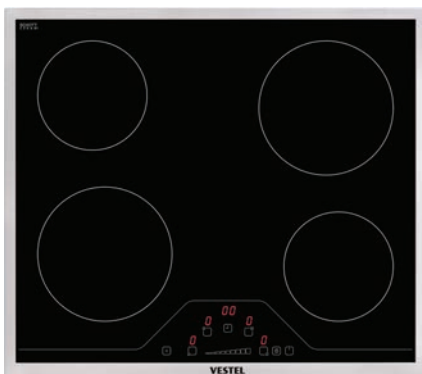
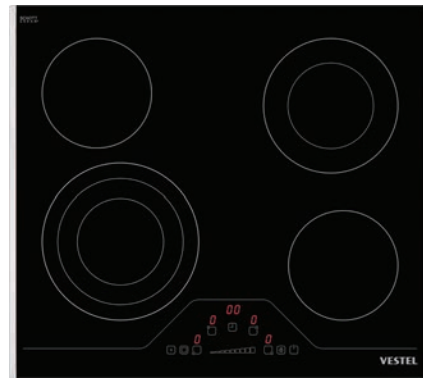

VFTC.06

STANDARD FEATURES

60 cm ceramic hob
 2 Ø 145 mm Highlite Element 1200W
 2 Ø 180 mm Highlite Element 1800W
 Child Lock
 Hot surface indicator
 Slim design ceran glass serigraphy
 Key Lock
 Smart pause (with slider)

OPTIONAL FEATURES

Slider touch control
 Timer
 Full inox frame

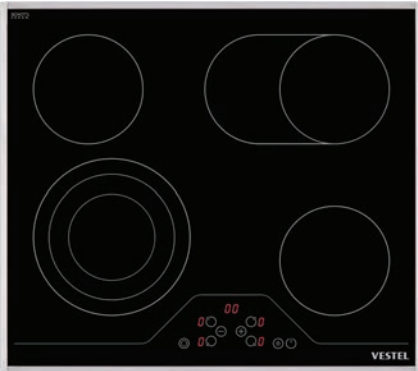

VFTC.07

STANDARD FEATURES

60 cm ceramic hob
 Front touch control
 2 Ø 145 mm Highlite Element 1200W
 Child lock
 Hot surface indicator
 Key Lock

OPTIONAL FEATURES

Ø 145 mm Oval Highlite Element
 1000W/1800W
 Ø 210 mm Triple Highlite Element
 800W/1600W/2300W
 Inox frame

VFTC.08

STANDARD FEATURES

60 cm ceramic hob
 Front touch control
 2 Ø 145 mm Highlite Element 1200W
 Ø 180 mm Highlite Element 1800W
 Child lock
 Hot surface indicator
 Key Lock

OPTIONAL FEATURES

Ø 180 mm Dual Highlite Element
 700W/1700W
 Bevelled edge glass
 White ceramic glass
 Timer

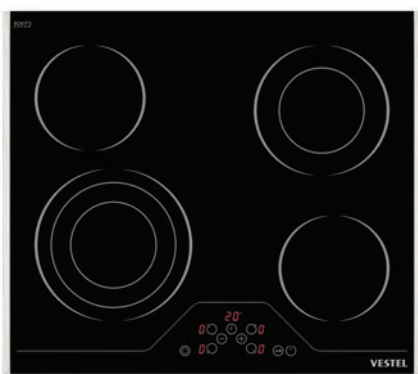
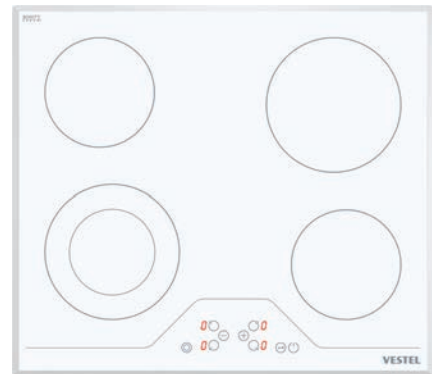

VFTC.09

STANDARD FEATURES

60 cm ceramic hob
 Front touch control
 2 Ø 145 mm Highlite Element 1200W
 Child lock
 Hot surface indicator
 Key Lock

OPTIONAL FEATURES

Ø 210 mm Triple Highlite Element
 800W/1600W/2300W
 Ø 180 mm Dual Highlite Element
 700W/1700W
 Two side inox frame
 Front side bevelled edge glass



VFTC.10

STANDARD FEATURES

60 cm ceramic hob
 Front touch control
 Ø 145 mm Highlite Element 1200W
 Ø 180 mm Highlite Element 1800W
 Child lock
 Hot surface indicator
 Key Lock

OPTIONAL FEATURES

Ø 270 mm Triple Highlite Element
 1050W/1950W/2700W
 Two side inox frame
 Front and back side bevelled edge
 glass

VFTC.11

STANDARD FEATURES

60 cm ceramic hob
 Front touch control
 Ø 145 mm Highlite Element 1200W
 Ø 180 mm Highlite Element 1800W
 Child lock
 Hot surface indicator
 Key Lock

OPTIONAL FEATURES

Ø 270 mm Dual Highlite Element
 1800W/2700W
 Timer
 Front side bevelled edge glass
 Slider touch control

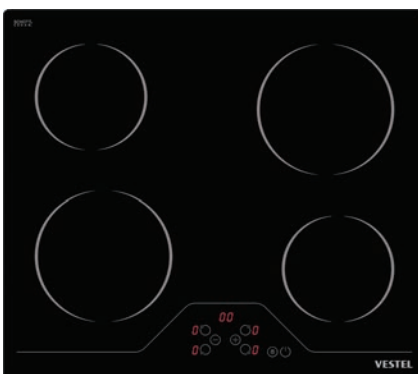

VFTC.12

STANDARD FEATURES

60 cm ceramic hob
 Front touch control
 2 Ø 145 mm Highlite Element 1200W
 2 Ø 180 mm Highlite Element 1800W
 Child lock
 Hot surface indicator
 Key Lock

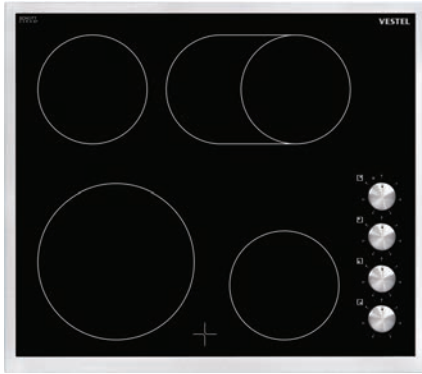

VKC.07

STANDARD FEATURES

60 cm ceramic hob
 Side knob control
 2 Ø 145 mm Highlite Element 1200W
 Hot surface indicator light
 Slim design ceran glass serigraphy

OPTIONAL FEATURES

Ø 145 mm Oval Highlite Element
 1000W/1800W
 210 mm highlite element 2300W
 Full inox frame

VKC.02

STANDARD FEATURES

60 cm ceramic hob
 Side knob control
 2 Ø 145 mm Highlite Element 1200W
 Hot surface indicator light

OPTIONAL FEATURES

Ø 180 mm Dual Highlite Element
 700W/1700W
 Ø 210 mm Highlite Element
 2300W
 Front and back side bevelled edge
 glass
 Inox knobs

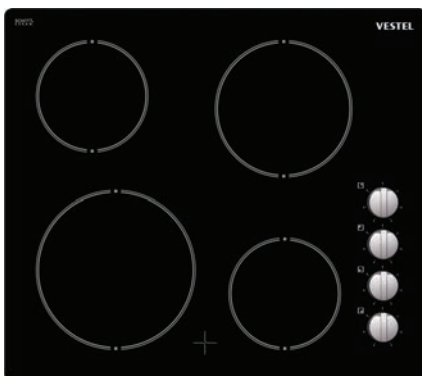

VKC.03

STANDARD FEATURES

60 cm ceramic hob
 Side knob control
 2 Ø 145 mm Highlite Element 1200W
 Ø 180 mm Highlite Element 1800W
 Hot surface indicator light

OPTIONAL FEATURES

Ø 210 mm Highlite Element
 2300W
 Inox knobs

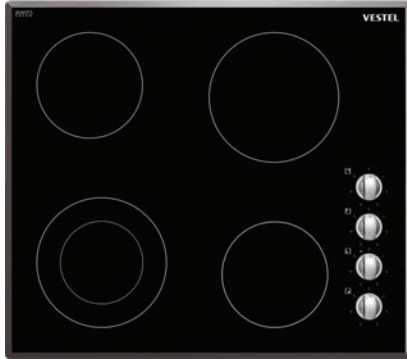

VKC.04

STANDARD FEATURES

60 cm ceramic hob
Side knob control
2 Ø 145 mm Highlite Element 1200W
Ø 180 mm Highlite Element 1800W
Hot surface indicator light

OPTIONAL FEATURES

Ø 180 mm Dual Highlite Element
700W/1700W
Bevelled edge glass
Inox knobs

VKC.05

STANDARD FEATURES

60 cm ceramic hob
Side knob control
2 Ø 145 mm Highlite Element 1200W
Hot surface indicator light

OPTIONAL FEATURES

Ø145mm Oval Highlite Element
1000W/1800W
Ø210mm Highlite Element 2300W
Front and back side bevelled edge
glass
Metal cladded knobs
White ceramic glass
Two side inox frame

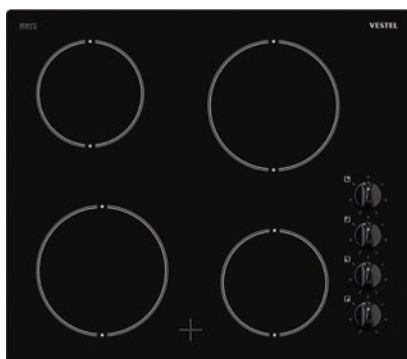
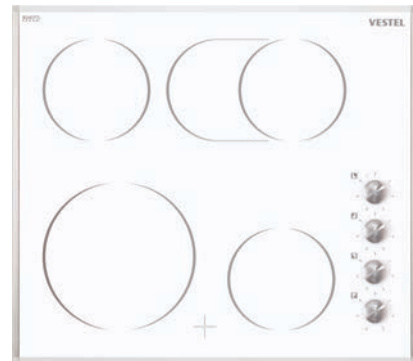

VKC.06

STANDARD FEATURES

60 cm ceramic hob
Side knob control
2 Ø 145 mm Highlite Element 1200W
2 Ø 180 mm Highlite Element 1800W
Hot surface indicator light

OPTIONAL FEATURES

Two side inox frame



VICH.01

STANDARD FEATURES

60 cm induction ceramic hob
 Combination with oven
 Knob controlled from oven
 Booster function
 2 Ø 160 mm 1400 W / Boost 1800 W induction element
 2 Ø 200 mm 2100 W / Boost 2500 W induction element
 Pot detection
 Child lock
 Hot surface indicator

Timer
 Slim design ceran glass serigraphy

OPTIONAL FEATURES

Full inox frame

VCH.02

STANDARD FEATURES

60 cm ceramic hob
 Combination with oven
 2 Ø 145 mm Highlite Element 1200W
 Hot surface indicator light

OPTIONAL FEATURES

Ø 180 mm Dual Highlite Element 700W/1700W
 Ø 145 mm Oval Highlite Element 1000W/1800W
 Bevelled edge glass

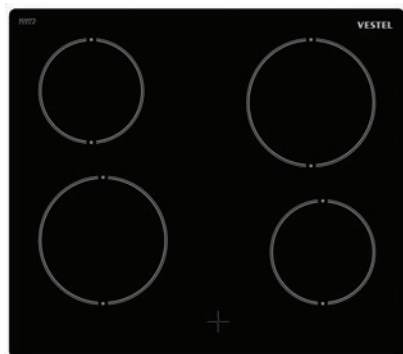
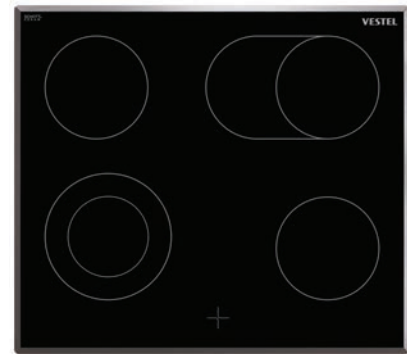

VCH.03

STANDARD FEATURES

60 cm ceramic hob
 Combination with oven
 2 Ø 145 mm Highlite Element 1200W
 2 Ø 180 mm Highlite Element 1800W
 Hot surface indicator light

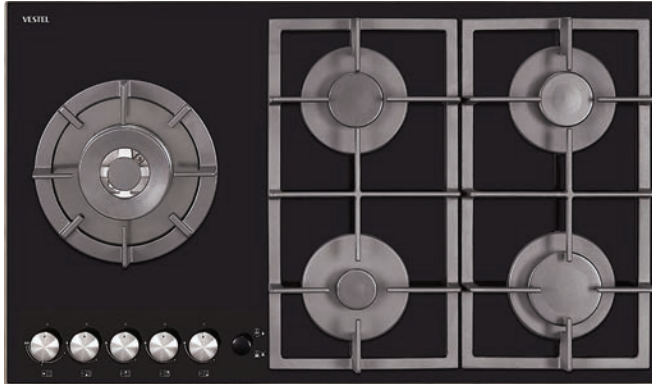

BGOGH.44

STANDARD FEATURES

- 90 cm gas on glass hob
- 5 gas burners
- High efficiency wok burner
- Front knob control
- Flame safety device
- Cast iron pan supports
- Cast iron burner caps
- Mat enamel burner pans

OPTIONAL FEATURES

- Dual work burner
- Cast iron high efficiency wok adapter
- Main switch
- White optical glass
- Inox burner pans
- Metal clad knobs
- One touch ignition

BGOGH.17

STANDARD FEATURES

- 70 cm gas on glass hob
- Plus X Design
- 5 gas burners
- Wok burner
- Front knob control
- Flame safety device

OPTIONAL FEATURES

- Mat enamel burner pans
- Mat enamel burner caps
- Cast iron pan supports
- Metal clad knobs
- One touch ignition



BGOGH.28

STANDARD FEATURES

- 70 cm gas on glass hob
- Plus X Design
- 5 gas burners
- Wok burner
- Front knob control
- Flame safety device

OPTIONAL FEATURES

- Mat enamel burner pans
- Mat enamel burner caps
- Cast iron pan supports
- Metal clad knobs
- One touch ignition



BGOGH.29

STANDARD FEATURES

- 70 cm gas on glass hob
- Plus X Design
- 5 gas burners
- Wok burner
- Front knob control
- Flame safety device

OPTIONAL FEATURES

- White optical glass
- Inox burner pans
- Mat enamel burner caps
- Cast iron pan supports
- (line design)
- Metal clad knobs
- One touch ignition

BGOGH.30

STANDARD FEATURES

- 70 cm gas on glass hob
- Plus X Design
- 5 gas burners
- Wok burner
- Front knob control
- Flame safety device

OPTIONAL FEATURES

- Mirror glass
- Inox burner pans
- Mat enamel burner caps
- Cast iron pan supports
- (deluxe design)
- Metal clad knobs
- One touch ignition



BGOGH.31

STANDARD FEATURES

- 70 cm gas on glass hob
- Plus X Design
- 5 gas burners
- Wok burner
- Front knob control
- Flame safety device

OPTIONAL FEATURES

- Mat enamel burner pans
- Cast iron burner caps
- Cast iron pan supports
- (deluxe design)
- Metal clad knobs
- One touch ignition



BGOGH.07

STANDARD FEATURES

70 cm gas on glass hob
5 gas burners
Front knob control

OPTIONAL FEATURES

Wok burner
Mirror glass
Inox burner pans
Stainless steel frame
Cast iron pan supports
Cast iron burner caps
One touch ignition
Flame safety device
Metal clad knobs

BGOGH.20

STANDARD FEATURES

60 cm gas on glass hob
Plus X Design
4 gas burners
Front knob control
Flame safety device

OPTIONAL FEATURES

Mat enamel burner pans
Mat enamel burner caps
Cast iron pan supports
(line design)
Metal clad knobs
One touch ignition



BGOGH.32

STANDARD FEATURES

60 cm gas on glass hob
Plus X Design
4 gas burners
Front knob control
Flame safety device

OPTIONAL FEATURES

Wok burner
Mat enamel burner pans
Mat enamel burner caps
Cast iron pan supports
(line design)
Metal clad knobs
One touch ignition

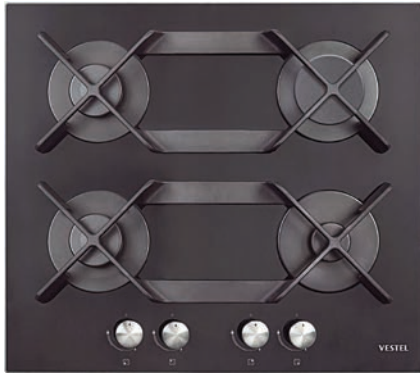

BGOGH.19

STANDARD FEATURES

60 cm gas on glass hob
 Plus X Design
 4 gas burners
 Front knob control
 Flame safety device

OPTIONAL FEATURES

Mat enamel burner pans
 Cast iron burner caps
 Cast iron pan supports
 Metal clad knobs
 One touch ignition

BGOGH.33

STANDARD FEATURES

60 cm gas on glass hob
 Plus X Design
 4 gas burners
 Front knob control
 Flame safety device

OPTIONAL FEATURES

Mirror glass
 Inox burner pans
 Mat enamel burner caps
 Cast iron pan supports
 Metal clad knobs
 One touch ignition



BGOGH.34

STANDARD FEATURES

60 cm gas on glass hob
 Plus X Design
 4 gas burners
 Front knob control
 Flame safety device

OPTIONAL FEATURES

Mirror glass
 Wok burner
 Inox burner pans
 Mat enamel burner caps
 Cast iron pan supports
 (deluxe design)
 Metal clad knobs
 One touch ignition



BGOGH.35

STANDARD FEATURES

60 cm gas on glass hob
 Plus X Design
 4 gas burners
 Front knob control
 Flame safety device

OPTIONAL FEATURES

White optical glass
 Wok burner
 Inox burner pans
 Mat enamel burner caps
 Cast iron pan supports
 Metal cladded knobs
 One touch ignition

BGOGH.36

STANDARD FEATURES

60 cm gas on glass hob
 Plus X Design
 4 gas burners
 Front knob control
 Flame safety device

OPTIONAL FEATURES

White optical glass
 Inox burner pans
 Mat enamel burner caps
 Cast iron pan supports
 Metal cladded knobs
 One touch ignition



BGOGH.18

STANDARD FEATURES

60 cm gas on glass hob
 Plus X Design
 Front knob control
 Flame safety device
 Enamel burner pans
 Enamel burner caps
 Enamel pan supports

OPTIONAL FEATURES

Metal cladded knobs
 One touch ignition
 3 gas burners and 145 mm hotplate



BGOGH.21

STANDARD FEATURES

60 cm gas on glass hob
 Plus X Design
 4 gas burners
 Front knob control
 Flame safety device

OPTIONAL FEATURES

Mat enamel burner pans
 Mat enamel burner caps
 Cast iron pan supports
 Metal clad knobs
 One touch ignition

BGOGH.09

STANDARD FEATURES

60 cm gas on glass hob
 4 gas burners
 Front knob control
 Black glass
 Enamel burner pans
 Enamel pan supports
 Enamel burner caps

OPTIONAL FEATURES

One touch ignition
 Flame safety device
 Inox frame



BGOGH.37

STANDARD FEATURES

60 cm gas on glass hob
 4 gas burners
 Front knob control
 Enamel pan supports
 Enamel burner caps
 Flame safety device

OPTIONAL FEATURES

Mirror glass
 Inox burner pans
 One touch ignition
 Inox frame



BGOGH.24

STANDARD FEATURES

- Pure Design
- 60 cm gas on glass and induction hob
- Side knob control and Side touch control
- 2 gas burners
- Enamel burner pans, pan supports and burner caps
- Flame safety device
- Booster function
- Ø 160 mm 1400 W / Boost 1800 W induction element
- Ø 200 mm 2100 W / Boost 2500 W

- induction element
- Pot detection and Automatic heat up
- Child lock and Hot surface indicator
- Key Lock
- Timer

OPTIONAL FEATURES

- Metal clad knobs
- One touch ignition

BGOGH.38

STANDARD FEATURES

- 60 cm gas on glass and induction hob
- Pure design
- Side knob control and side touch control
- 2 gas burners - Flame safety device
- Ø 160 mm 1400 W / Boost 1800 W induction element
- Ø 200 mm 2100 W / Boost 2500 W induction element
- Pot detection
- Child lock
- Hot surface indicator

- Touch control interface for induction zones
- Key Lock
- Timer

OPTIONAL FEATURES

- Mat enamel burner pans and caps
- Cast iron pan supports
- Metal clad knobs
- Full inox frame
- One touch ignition



BGOGH.25

STANDARD FEATURES

- 60cm gas on glass and vitroceramic hob
- Pure design
- Side knob control
- 2 gas burners
- Flame safety device
- Ø 145 mm Highlite Element 1200W
- Ø 180 mm Highlite Element 1800W
- Hot surface indicator

OPTIONAL FEATURES

- Mat enamel burner pans
- Mat enamel burner caps
- Cast iron pan supports
- Metal clad knobs
- Full inox frame
- One touch ignition

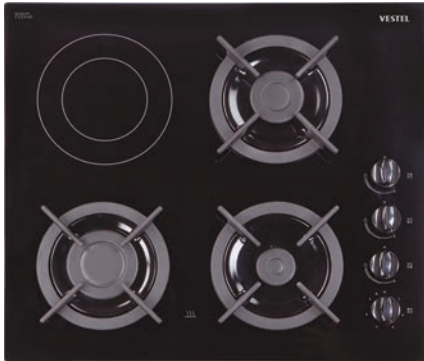

BGOGH.23

STANDARD FEATURES

Pure Design
60 cm gas on glass and vitroceramic hob
Side knob control
3 gas burners
Enamel burner pans
Flame safety device
Hot surface indicator

OPTIONAL FEATURES

Cast iron pan supports
Cast iron burner caps
Ø 180 mm Dual Highlite Element
700W/1700W
One touch ignition

BGOGH.40

STANDARD FEATURES

60 cm gas on glass and vitroceramic hob
Pure design
Side knob control
2 gas burners
Enamel burner pans
Enamel pan supports
Enamel burner pans
Flame safety device
Hot surface indicator
Ø 145 mm Highlite Element 1200W
Ø 180 mm Highlite Element 1800W

OPTIONAL FEATURES

Full inox frame
One touch ignition



BGOGH.39

STANDARD FEATURES

60 cm gas on glass and vitroceramic hob
Pure design - Side knob control
3 gas burners
Flame safety device
Ø 180 mm Highlite Element 1800W
Hot surface indicator

OPTIONAL FEATURES

Mat enamel burner pans and caps
Cast iron pan supports
Metal clad knobs
Full inox frame
One touch ignition



BGOGH.43

STANDARD FEATURES

- 60 cm gas on glass hob
- Division design
- 4 gas burners
- Front knob control
- Flame safety device
- Cast iron pan supports
- Enamel burner caps
- Enamel burner caps

OPTIONAL FEATURES

- Metal clad knobs
- One touch ignition

BGOGH.41

STANDARD FEATURES

- 60 cm gas on glass hob
- 3 gas burners
- Wok burner
- Side knob control
- Flame safety device

OPTIONAL FEATURES

- Mat enamel burner pans
- Mat enamel burner caps
- Mat enamel pan supports
- One touch ignition



BGOGH.05

STANDARD FEATURES

- 60 cm gas on glass hob
- 4 gas burners
- Side knob control
- Black Glass
- Enamel burner pans
- Flame safety device

OPTIONAL FEATURES

- Wok burner
- Cast iron burner caps
- Cast iron pan supports
- One touch ignition



BGOGH.11

STANDARD FEATURES

- 60 cm gas on glass hob
- 4 gas burners
- Side knob control
- Enamel burner caps
- Enamel pan supports
- Flame safety device

OPTIONAL FEATURES

- Inox burner pans
- Inox colored optical glass
- Metal clad knobs
- One touch ignition

BGOGH.26

STANDARD FEATURES

- 60 cm gas on glass hob
- 4 gas burners
- Side knob control
- Flame safety device

OPTIONAL FEATURES

- Mat enamel burner caps
- Mat enamel pan supports
- Mat enamel burner pans
- White optical glass
- One touch ignition



BGOGH.13

STANDARD FEATURES

- 60 cm gas on glass hob
- 4 gas burners
- Side knob control

OPTIONAL FEATURES

- Wok burner
- Mirror glass
- Inox burner pans
- Cast iron pan supports
- Cast iron burner caps
- One touch ignition
- Flame safety device
- Metal clad knobs



BGOGH.16

STANDARD FEATURES

- 60 cm gas on glass hob
- 4 gas burners
- Side knob control
- Black glass
- Enamel pan supports
- Enamel burner caps
- Inox burner pans

OPTIONAL FEATURES

- One touch ignition
- Flame safety device
- Metal clad knobs
- Inox burner pans

BGOGH.01

STANDARD FEATURES

- 60 cm gas on glass hob
- 4 gas burners
- Side knob control
- Enamel burner caps
- Enamel pan supports
- Enamel burner pans
- Flame safety device

OPTIONAL FEATURES

- Metal clad knobs
- One touch ignition

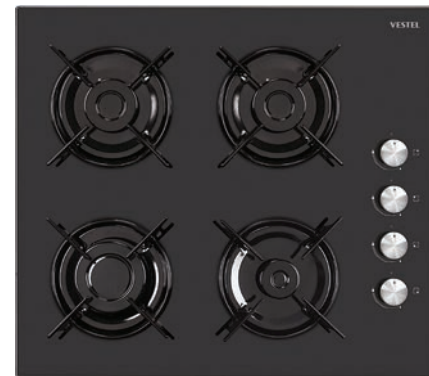

BGOGH.42

STANDARD FEATURES

- 60 cm gas on glass hob
- 4 gas burners
- Side knob control
- Enamel burner caps
- Enamel pan supports
- Flame safety device

OPTIONAL FEATURES

- Inox burner pans
- White optical glass
- Metal clad knobs
- One touch ignition



BGOGH.27 Rustic

STANDARD FEATURES

- 60 cm gas on glass hob
- 4 gas burners
- Side knob control
- Flame safety device
- Enamel burner caps
- Enamel pan supports
- Enamel burner pans

OPTIONAL FEATURES

- Type-C Rustic design black optical glass
- One touch ignition
- Flame safety device
- Special rustic knobs

BGOGH.12 Rustic

STANDARD FEATURES

- 60 cm gas on glass hob
- 4 gas burners
- Side knob control
- Flame safety device
- Enamel burner caps
- Enamel pan supports
- Enamel burner pans

OPTIONAL FEATURES

- Type-C Rustic design cream optical glass
- One touch ignition
- Flame safety device
- Special rustic knobs



BGOGH.15 Rustic

STANDARD FEATURES

- 60 cm gas on glass hob
- 4 gas burners
- Side knob control
- Flame safety device
- Enamel burner caps
- Enamel pan supports
- Enamel burner pans

OPTIONAL FEATURES

- Type-B Rustic design white optical glass
- One touch ignition
- Flame safety device
- Special rustic knobs



BGH.44

STANDARD FEATURES

70 cm gas hob
 Plus X Design
 5 gas burners
 Wok burner
 Front knob control
 Flame safety device

OPTIONAL FEATURES

Stainless steel
 Glass control panel
 Mat enamel burner caps
 Cast iron pan supports
 Metal clad knobs - Wok adaptor
 One touch ignition

BGH.45

STANDARD FEATURES

70 cm gas hob
 Plus X Design
 5 gas burners
 Wok burner
 Front knob control
 Enamel pan supports
 Enamel burner pans
 Flame safety device

OPTIONAL FEATURES

Stainless steel
 Inox painted knobs
 Wok adaptor
 One touch ignition



BGH.46

STANDARD FEATURES

70 cm gas hob
 Plus X Design
 5 gas burners
 Wok burner
 Front knob control
 Flame safety device

OPTIONAL FEATURES

Stainless steel
 Mat enamel burner caps
 Cast iron pan supports
 Inox painted knobs
 One touch ignition





BGH.47

STANDARD FEATURES

60 cm gas hob
 Plus X Design
 4 gas burners
 Front knob control
 Flame safety device

OPTIONAL FEATURES

Stainless steel
 Wok burner
 Mat enamel burner caps
 Cast iron pan supports
 Glass control panel
 Metal clad knobs
 One touch ignition

BGH.48

STANDARD FEATURES

60 cm gas hob
 Plus X Design
 4 gas burners
 Front knob control
 Flame safety device

OPTIONAL FEATURES

Stainless steel
 Cast iron burner caps
 Cast iron pan supports
 Glass control panel
 Metal clad knobs
 One touch ignition



BGH.49

STANDARD FEATURES

60 cm gas hob
 Plus X Design
 4 gas burners
 Front knob control
 Enamel pan supports
 Enamel burner pans
 Flame safety device

OPTIONAL FEATURES

Stainless steel
 Glass control panel
 Metal clad knobs
 One touch ignition



BGH.50

STANDARD FEATURES

- 60 cm gas hob
- Plus X Design
- 4 gas burners
- Front knob control
- Enamel pan supports
- Enamel burner pans
- Flame safety device

OPTIONAL FEATURES

- Metal clad knobs
- One touch ignition

BGH.51

STANDARD FEATURES

- 60 cm gas hob
- Plus X Design
- 4 gas burners
- Front knob control
- Enamel pan supports
- Enamel burner caps
- Flame safety device

OPTIONAL FEATURES

- Stainless steel
- Metal clad knobs
- One touch ignition



BGH.52

STANDARD FEATURES

- 60 cm gas hob
- Division design
- 4 gas burners
- Front knob control
- Flame safety device
- Cast iron pan supports
- Mat enamel burner caps
- Stainless steel hob

OPTIONAL FEATURES

- Metal clad knobs
- One touch ignition



BGH.56

STANDARD FEATURES

70cm gas hob
5 gas burners
Front knob control

OPTIONAL FEATURES

Stainless steel hob
Wok burner
Cast iron pan supports
Cast iron burner caps
One touch ignition
Flame Safety device

BGH.18

STANDARD FEATURES

70 cm gas hob
5 gas burners
Front knob control
White enamel hob
Enamel pan supports
Enamel burner caps

OPTIONAL FEATURES

Wok burner
Button ignition
Flame safety device
Enamel wok adapter



BGH.38

STANDARD FEATURES

70 cm gas hob
5 gas burners
Front knob control
Enamel pan supports
Enamel burner caps

OPTIONAL FEATURES

Stainless steel hob
Button ignition
Flame safety device





BGH.19

STANDARD FEATURES

70 cm mixed hob
4 gas burners
145 mm hotplate
Front knob control

OPTIONAL FEATURES

Black enamel hob
1 electric hotplate
Cast iron pan supports
Cast iron burner caps
One touch ignition
Flame safety device

BGH.27

STANDARD FEATURES

60 cm gas hob
4 gas burners
Front knob control
Enamel burner caps
Enamel pan support
Flame safety device

OPTIONAL FEATURES

One touch ignition
Stainless steel hob



BGH.26

STANDARD FEATURES

60 cm gas hob
4 gas burners
Front knob control
White enamel hob
Enamel burner caps
Enamel pan support

OPTIONAL FEATURES

One touch ignition
Flame safety device



BGH.55

STANDARD FEATURES

60 cm gas hob
4 gas burners
Front knob control
Enamel pan supports
Enamel burner caps
Flame safety device

OPTIONAL FEATURES

One touch ignition
Metal clad knobs

BGH.25

STANDARD FEATURES

60 cm gas hob
4 gas burners
Front knob control

OPTIONAL FEATURES

Stainless steel hob
Wok burner
Cast iron burner caps
Cast iron pan supports
One touch ignition
Flame safety device



BGH.34

STANDARD FEATURES

60 cm gas hob
4 gas burners
Front knob control
Enamel pan supports
Enamel burner caps

OPTIONAL FEATURES

Black enamel hob
One touch ignition
Flame safety device
Metal clad knobs



BGH.29

STANDARD FEATURES

60 cm gas hob
 Surface design
 4 gas burners
 Side knob control
 Enamel pan supports
 Enamel burner caps
 Flame safety device

OPTIONAL FEATURES

Stainless steel hob
 One touch ignition

BGH.02

STANDARD FEATURES

60 cm gas hob
 Surface design
 3 gas burners
 Ø 180mm hotplate
 Side knob control
 Flame safety device

OPTIONAL FEATURES

Stainless steel hob
 One touch ignition
 Cast iron pan supports
 Cast iron burner caps
 Metal clad knobs



BGH.03

STANDARD FEATURES

60 cm mixed hob
 3 gas burners
 180 mm hotplate
 Side knob control
 Enamel pan supports
 Enamel burner caps

OPTIONAL FEATURES

Stainless steel hob
 Electric hotplate
 One touch ignition
 Flame safety device



BGH.05

STANDARD FEATURES

60 cm gas hob
Surface design
4 gas burners
Side knob control
Enamel pan supports
Enamel burner caps
Flame safety device
White enamel hob

OPTIONAL FEATURES

One touch ignition

BGH.07

STANDARD FEATURES

60 cm gas hob
Surface design
3 gas burners
Ø 180mm hotplate
Side knob control
Enamel pan supports
Enamel burner caps
Flame safety device
White enamel hob

OPTIONAL FEATURES

One touch ignition



BGH.08

STANDARD FEATURES

60 cm gas hob
White enamel hob
4 gas burners
Side knob control
Enamel pan supports
Enamel burner caps

OPTIONAL FEATURES

One touch ignition
Flame safety device



BGH.09

STANDARD FEATURES

60 cm gas hob
Surface design
4 gas burners
Side knob control
Flame safety device

OPTIONAL FEATURES

Stainless steel hob
One touch ignition
Wok burner
Cast iron pan supports
Cast iron burner caps

BGH.10

STANDARD FEATURES

60 cm gas hob
Surface design
3 gas burners
Ø 180mm hotplate
Side knob control
Flame safety device

OPTIONAL FEATURES

One touch ignition
Black enamel hob
Cast iron pan supports
Cast iron burner caps
Mat black knobs



BGH.01

STANDARD FEATURES

60 cm gas hob
Surface design
4 gas burners
Side knob control
Flame safety device

OPTIONAL FEATURES

Stainless steel hob
One touch ignition
Metal clad knobs
Cast iron pan supports
Cast iron burner caps



BGH.43

STANDARD FEATURES

60 cm gas hob
 Extenda design
 4 gas burners
 Side knob control
 Flame safety device

OPTIONAL FEATURES

Stainless steel
 Cast iron burner caps
 Cast iron pan supports
 One touch ignition
 Metal clad knobs

BGH.53

STANDARD FEATURES

60 cm mixed hob
 Smootline design
 3 gas burners
 Ø 180 mm hotplate
 Side knob control
 Enamel pan supports
 Enamel burner camps
 Flame safety device

OPTIONAL FEATURES

One touch ignition



BGH.54

STANDARD FEATURES

60 cm gas hob
 Smootline design
 4 gas burners
 Side knob control
 Enamel pan supports
 Enamel burner caps
 Flame safety device

OPTIONAL FEATURES

Black enamelled hob
 One touch ignition



BGH.40

STANDARD FEATURES

Smoothline design
60 cm gas hob
4 gas burners
Side Knob control
Enamel pan supports
Enamel burner caps

OPTIONAL FEATURES

Stainless steel hob
Button ignition
Flame safety device
Metal clad knobs

BGH.39

STANDARD FEATURES

Smoothline design
60 cm gas hob
4 gas burners
Side Knob control
Enamel pan supports
Enamel burner caps
White enamel hob

OPTIONAL FEATURES

One touch ignition
Flame safety device



BGH.41

STANDARD FEATURES

Smoothline design
60 cm gas hob
4 gas burners
Side Knob control
Enamel pan supports
Enamel burner caps

OPTIONAL FEATURES

TDF enamel hob
One touch ignition
Flame safety device
Black knobs



BGH.30 Rustic

STANDARD FEATURES

60 cm gas hob
Surface design
4 gas burners
Side knob control
Flame safety device
Enamel pan supports
Enamel burner caps

OPTIONAL FEATURES

Type-A Rustic design
Special rustic knobs
One touch ignition
Black enamel hob

BGH.31 Rustic

STANDARD FEATURES

60 cm gas hob
Surface design
4 gas burners
Side knob control
Flame safety device
Enamel pan supports
Enamel burner caps
White enamel hob

OPTIONAL FEATURES

Type-A Rustic design
One touch ignition



BGH.28 Rustic

STANDARD FEATURES

60 cm gas hob
Surface design
4 gas burners
Side knob control
Flame safety device

OPTIONAL FEATURES

Type-B Rustic design
Special rustic knobs
One touch ignition
Black enamel hob
Cast iron pan supports
Cast iron burner caps





BEH.01

STANDARD FEATURES

60cm electric hob
Surface design
4 solid hotplates
(2x145mm)+(2x180mm)
Side knob control

OPTIONAL FEATURES

Stainless steel hob
Black knobs

BEH.02

STANDARD FEATURES

60cm electric hob
Surface design
4 solid hotplates
(2x145mm)+(2x180mm)
Side knob control

OPTIONAL FEATURES

Black enamel hob
Inox painted knobs



BEH.05

STANDARD FEATURES

60cm electric hob
Surface design
4 solid hotplates
(2x145mm)+(2x180mm)
Side knob control

OPTIONAL FEATURES

Stainless steel hob



BCH.01

FEATURES

60 cm electrical combi hob
 White enamel hob
 Combination with oven
 4 solid hotplates
 (2x145mm) + (2x180mm)

BCH.02

FEATURES

60 cm electrical combi hob
 Black enamel hob
 Combination with oven
 4 solid hotplates
 (2x145mm) + (2x180mm)



BCH.03

STANDARD FEATURES

60 cm electrical combi hob
 Combination with oven
 4 solid hotplates (2x145mm) +
 (2x180mm)

OPTIONAL FEATURES

1 Rapid hotplate
 Stainless steel hob





DVHS2.02 Domino Series 2

STANDARD FEATURES

30 cm ceramic hob
 Domino series 2 design
 Front touch control
 Ø 145 mm Highlite Element 1200W
 700W/1700W
 Hot surface indicator

OPTIONAL FEATURES

Ø 180 mm Dual Highlite Element
 Timer

DVHS2.01 Domino Series 2

STANDARD FEATURES

30 cm ceramic hob
 Domino series 2 design
 Front knob control
 Ø 145 mm Highlite Element 1200W
 700W/1700W
 Hot surface indicator light

OPTIONAL FEATURES

Ø 180 mm Dual Highlite Element
 Metal clad knobs

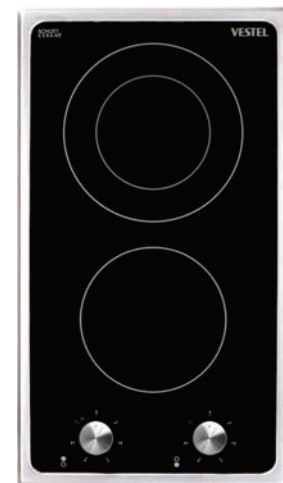

DEHS2.02 Domino Series 2

STANDARD FEATURES

30 cm electric hob
 Domino series 2 design
 Front knob control
 Ø 145 mm solid hotplate
 Ø 180 mm rapid hotplate

OPTIONAL FEATURES

Metal clad knobs
 Mechanical timer
 1 rapid zone



DEHS2.01 Domino Series 2

STANDARD FEATURES

30 cm electric hob
 Domino series 2 design
 Front knob control
 Ø 145 mm solid hotplate
 Ø 180 mm rapid hotplate

OPTIONAL FEATURES

Metal clad knobs
 1 rapid zone

DGHS2.01 Domino Series 2

STANDARD FEATURES

30 cm gas on glass hob
 Domino series 2 design
 Black glass
 2 gas burners
 Flame safety device

OPTIONAL FEATURES

Cast iron pan supports
 Cast iron burner caps
 Inox burner pans
 One touch ignition
 Metal clad knobs



DGHS2.04 Domino Series 2

STANDARD FEATURES

30 cm gas hob
 Domino series 2 design
 Stainless steel hob
 2 gas burners
 Flame safety device

OPTIONAL FEATURES

Cast iron pan supports
 Cast iron burner caps
 One touch ignition
 Metal clad knobs



DGHS2.03 Domino Series 2

STANDARD FEATURES

30 cm gas on glass hob
Domino series 2 design
Black glass
2 gas burners
Enamel pan supports
Enamel burner caps
Flame safety device

OPTIONAL FEATURES

Inox burner pans
One touch ignition
Metal cladded knobs

DGHS2.06 Domino Series 2

STANDARD FEATURES

30 cm gas hob
Domino series 2 design
Stainless steel hob
2 gas burners
Enamel pan supports
Enamel burner caps
Flame safety device

OPTIONAL FEATURES

Button ignition



DGHS2.02 Domino Series 2

STANDARD FEATURES

30 cm gas on glass hob
Domino series 2 design
Black glass
Wok burner
Flame safety device

OPTIONAL FEATURES

Metal enamel burner pan
Cast iron pan support
Cast iron burner caps
One touch ignition
Metal cladded knobs





DGHS2.05 Domino Series 2

STANDARD FEATURES

30 cm gas hob
Domino series 2 design
Stainless steel hob
Wok burner
Flame safety device
Metal knob

OPTIONAL FEATURES

Mat enamel pan support
Mat enamel burner pan
One touch ignition

DIHS1.01 Domino Series 1

STANDARD FEATURES

30 cm induction hob
Front touch control
Booster function
Ø 160 mm 1400 W / Boost 1800 W
induction element
Ø 200 mm 2100 W / Boost 2500 W
induction element
Pot detection
Automatic heat up
Child lock
Hot surface indicator

OPTIONAL FEATURES

Timer

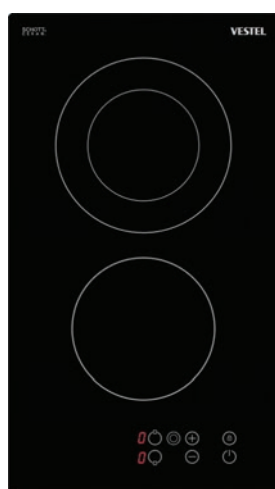
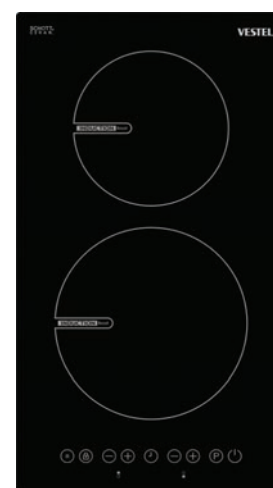

DVHS1.03 Domino Series 1

STANDARD FEATURES

30 cm ceramic hob
Front touch control
Ø 145 mm Highlite Element 1200W
700W/1700W
Child lock
Hot surface indicator
Key lock
Smart Pause

OPTIONAL FEATURES

Ø 180 mm Dual Highlite Element

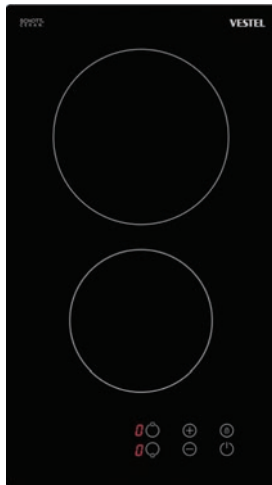

DVHS1.05 Domino Series 1

STANDARD FEATURES

- 30 cm ceramic hob
- Front touch control
- Ø 145 mm Highlite Element 1200W
- Ø 180 mm Highlite Element 1800W
- Child lock
- Hot surface indicator

DVHS1.01 Domino Series 1

STANDARD FEATURES

- 30 cm ceramic hob
- Front knob control
- Ø 145 mm Highlite Element 1200W
- Ø 180 mm Highlite Element 1800W
- Hot surface indicator light

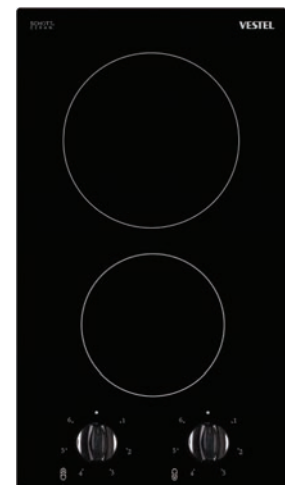

DGHS1.03 Domino Series 1

STANDARD FEATURES

- 30 cm gas on glass hob
- Domino series 1 design
- Black glass
- 2 gas burners
- Flame safety device

OPTIONAL FEATURES

- Cast iron pan supports
- Cast iron burner caps
- Inox burner pans
- One touch ignition



DGHS1.04 Domino Series 1

STANDARD FEATURES

30 cm gas on glass hob
Domino series 1 design
Black glass
Wok burner
Flame safety device

OPTIONAL FEATURES

Mat enamel pan support
Mat enamel burner pan
Inox burner pan
One touch ignition

DGHS1.01 Domino Series 1

STANDARD FEATURES

30 cm gas on glass hob
Domino series 1 design
Black glass
2 gas burners
Enamel pan supports
Enamel burner caps
Enamel burner pans
Flame safety device

OPTIONAL FEATURES

One touch ignition



DGHS1.02 Domino Series 1

STANDARD FEATURES

30 cm gas on glass hob
Domino series 1 design
Black glass
2 gas burners
Enamel burner pans
Flame safety device

OPTIONAL FEATURES

Cast iron pan supports
Cast iron burner caps
One touch ignition

TABLE TOP HOB SPECIFICATIONS

BUILT-IN / TABLE-TOP HOB SPECIFICATION SHEET	TT Gas/ Comlined/ Gas Securit Hobs				TT Electric Hobs			
	60 CM	60 CM	60 CM	60 CM	60 CM	60 CM	60 CM	
	Flat / Surface	Smoothline	New Gen.	PlusX	Flat / Surface	Smoothline	New Gen.	
Available Colours								
White		Standard	Standard	Standard	Optional	Standard	Standard	Standard
Brown		Optional	Optional	-	Optional	Optional	Optional	-
Terre de France		Optional	Optional	-	Optional	Optional	Optional	-
Black		Optional	Optional	Optional	Standard	Optional	Optional	Optional
Dark Green		Optional	Optional	-	Optional	Optional	Optional	-
Stainless Steel		Optional	Optional	Optional	Optional	Optional	Optional	Optional
Product Dimensions								
Height (max., varies from model to model)	mm	95,5 - 104,5	95,5 - 104,5	95,5 - 104,5	104	56,5 - 104,5	56,5 - 104,5	56,5 - 104,5
Width	mm	585	585	580	597	585	585	585
Depth (max., do not include gas connection detail)	mm	540	540	540	526	540	540	540
Hob Features								
Hob		Enamel / Stainless Steel	Enamel / Stainless Steel	Enamel / Stainless Steel	Securit	Enamel / Stainless Steel	Enamel / Stainless Steel	Enamel / Stainless Steel
Rapid Gas Burner Ø10cm	W	3000	3000	3000	3000	-	-	-
Semi-rapid Gas Burner Ø7.5cm	W	1750	1750	1750	1750	-	-	-
Auxiliary Gas Burner Ø5.5cm	W	1000	1000	1000	1000	-	-	-
Wok (Triple Flame) Gas Burner Mono Ø14cm	W	3800	3600	3600	3600	-	-	-
Wok (Triple Flame) Gas Burner Dual Ø14cm	W	-	-	-	-	-	-	-
Wok (Triple Flame) Gas Burner Ø11cm	W	-	-	-	-	-	-	-
Ø 145 mm Hotplate	W	-	1000	-	1000	1000	1000	1000
Ø 180 mm Hotplate	W	1500	-	1500	-	1500	1500	1500
Ø 145 mm Rapid Hotplate	W	-	1500	-	-	1500	1500	1500
Ø 180 mm Rapid Hotplate	W	2000	-	2000	-	2000	2000	2000
Hotplate Operation Indicator Light		Standard	Standard	Standard	Standard	Standard	Standard	Standard
Side Knob Control		Standard	Standard	Standard	-	Standard	Standard	Standard
Front Knob Control		-	-	-	Standard	-	-	-
Bevelled Edges		-	-	-	-	-	-	-
Logo		Standard	Standard	Standard	Standard	Standard	Standard	Standard
Special Decoration on Glass		-	-	-	-	-	-	-
Stainless Steel Burner Pan		-	-	-	-	-	-	-
Table Top Installation (not built-in)		Standard	Standard	Standard	Standard	Standard	Standard	Standard
Glass Lid		Optional	Optional	Optional	-	Optional	Optional	Optional
Burner Safety Valves		Standard	Standard	Standard	Standard	-	-	-
Button Ignition		Standard	Optional	Optional	Optional	-	-	-
One-touch-Ignition through knobs		Optional	Optional	Optional	Optional	-	-	-
Enamel Pan Supports		Standard	Standard	Standard	Standard	-	-	-
Cast Iron Pan Supports		Optional	Optional	Optional	Optional	-	-	-
Cast Iron Burner Caps		Optional	Optional	Optional	Optional	-	-	-
Coffee Adaptor		Optional	Optional	Optional	Optional	-	-	-
Wok Adaptor		Optional	Optional	Optional	Optional	-	-	-
Gas Conversion Kit		Standard	Standard	Standard	Standard	-	-	-
Others								
Total Gas Power (Depends on Model) Maximum	kW	8,3	8,1	8,1	8,1	-	-	-
Total Electric Power (Depends on Model) Maximum	kW	-	-	-	1	6	6	6
Voltage	V	230V~	230V~	230V~	230V~	230 / 400V 3N~	230 / 400V 3N~	230 / 400V 3N~
RoHS Compliance		Standard	Standard	Standard	Standard	Standard	Standard	Standard
CE Compliance		Standard	Standard	Standard	Standard	Standard	Standard	Standard
Carton Box Packaging		Standard	Standard	Standard	Standard	Standard	Standard	Standard
Packed Product Dimensions (WxDxH)	mm	643 x 645 x 132	643 x 645 x 132	x	x	643 x 645 x 132	643 x 645 x 132	x
Packed Product Dimensions (WxDxH) Box	mm	662 x 648 x 140	662 x 648 x 140	662 x 648 x 140	645 x 648 x 140	662 x 648 x 140	662 x 648 x 140	662 x 648 x 140
Net Weight (Depends on Model) Maximum	kg	13	13	14	15	13,5	13,5	14,5
Gross Weight (Depends on Model) Maximum	kg	14,25	14,25	15	16	14,75	14,75	15,5

Table Top Hob Designs



New Generation Gas On Glass Design



New Generation Design



Standard Design

Table Top Hob Aesthetics



New Generation Gas On Glass Table Top Hob Aesthetic



New Generation Table Top Hob Aesthetic



Standard Design "S-Type" Table Top Hob Aesthetic



Standard Design "R-Type" Table Top Hob Aesthetic



Standard Design "Smootline" Table Top Hob Aesthetic



Standard Design "Surface" Table Top Hob Aesthetic

Table Top Frame Color



White Painted



Black Painted



Inox Painted



Silver Painted



Stainless Steel
only available for gas on glass table top hob



TTGGH-S2.01

STANDARD FEATURES

60cm gas on glass table top hob
4 gas burners
Front knob control
Enamel burner pan
Enamel burner caps and pan supports
Flame Safety Device

OPTIONAL FEATURES

White optical glass cooktop
White table top frame
One touch ignition
Inox cladded knobs

TTGGH-S2.02

STANDARD FEATURES

60cm gas on glass table top hob
3 gas burners and 145mm hotplate
Front knob control
Black glass cooktop
Black table top frame
Enamel burner pan supports
Flame Safety Device

OPTIONAL FEATURES

Cast Iron burner caps
Cast Iron pan supports
One touch ignition
Stainless steel table top frame
Inox cladded knobs



TTGGH-S2.03

STANDARD FEATURES

60cm gas on glass table top hob
4 gas burners
Front knob control
Black glass cooktop
Black table top frame
Enamel burner pan supports
Flame Safety Device

OPTIONAL FEATURES

Wok Burner
Cast Iron burner caps
Cast Iron pan supports
One touch ignition
Inox cladded knobs



TTGH-S2.01



STANDARD FEATURES

60 cm table top gas hob
New generation table top hob design
4 gas burners
Side knob control
Enamel cooktop
Enamel burner pan supports
Flame Safety Device

OPTIONAL FEATURES

One touch ignition

TTEH-S2.01

STANDARD FEATURES

60 cm table top electric hob
New generation table top hob design
4 solid hotplates
(2x145mm)+(2x180mm)
Side knob control
Enamel cooktop

OPTIONAL FEATURES

Rapid Hotplates (145mm and 180 mm)



TTGH-S2.02



STANDARD FEATURES

60 cm table top gas hob
New generation table top hob design
4 gas burners
Side knob control
Flame Safety Device

OPTIONAL FEATURES

Stainless steel cooktop
Wok Burner
One touch ignition
Cast iron pan support
Cast iron burner caps
Glass cover lid
Inox painted knobs

TTGH-S1.01



STANDARD FEATURES

60 cm table top gas hob
 Standard type table top hob design
 Flat R-type cooktop aesthetics
 3 gas burners
 Ø180mm hotplate
 Side knob control
 Enamel pan supports and burner caps
 Flame Safety Device

OPTIONAL FEATURES

Stainless steel cooktop
 Inox painted table top frame
 One touch ignition
 Black Knobs

TTEH-S1.02

STANDARD FEATURES

60 cm table top electrical hob
 Standard type table top hob design
 Flat S-type cooktop aesthetics
 4 solid hotplates
 (2x145mm)+(2x180mm)
 Side knob control

OPTIONAL FEATURES

Stainless steel cooktop
 Inox clad knobs
 Inox painted table top frame



TTGH-S1.02



STANDARD FEATURES

60 cm table top gas hob
 Standard type table top hob design
 Smootline cooktop aesthetics
 3 gas burners
 Ø145mm hotplate
 Side knob control
 Enamel cooktop
 Enamel burner pan supports
 Flame Safety Device

OPTIONAL FEATURES

One touch ignition
 Inox painted knobs

TTGH-S1.03



STANDARD FEATURES

60 cm table top gas hob
 Standard type table top hob design
 Smootline cooktop aesthetics
 4 gas burners
 Side knob control
 Enamel burner caps and pan supports
 Flame Safety Device

OPTIONAL FEATURES

Stainless steel cooktop
 One touch ignition
 Inox painted knobs
 Inox painted table top frame

TTGH-S1.04

STANDARD FEATURES

60 cm table top gas hob
 Standard type table top hob design
 Flat R-type cooktop aesthetics
 4 gas burners
 Side knob control
 Enamel cooktop
 Enamel burner caps and pan supports
 Flame Safety Device

OPTIONAL FEATURES

One touch ignition
 Glass lid



TTGH-S1.05



STANDARD FEATURES

60 cm table top gas hob
 Standard type table top hob design
 Surface cooktop aesthetics
 4 gas burners
 Side knob control
 Flame Safety Device

OPTIONAL FEATURES

Stainless steel cooktop
 Wok Burner
 Cast Iron burner caps and pan supports
 One touch ignition
 Inox painted table top frame
 Glass lid
 Black knobs

REFRIGERATORS // SPECIFICATIONS

BUILT IN												
Model	3200		3200 TURBO		2610		2400		2500		1800	
Refrigerator Class	7		7		7		7		1		7	
Climatic Class	BGN (16 °C-32°C)		BGT/N (16 °C-43°C)		BGN (16 °C-32°C)		BGN (16 °C-32°C)		BGN (16 °C-32°C)		BGN (16 °C-32°C)	
Energy Class	A+	A	B	A+	A++	A++	A+	A++	A+	A++	A+	A+
Volume Total (gross)	lt	276	276	276	217	217	195	195	206	206	153	153
Volume Total (net)	lt	261	261	260	214	214	192	192	204	204	150	150
Volume refrigerator (gross)	lt	192	192	192	179	179	178	178	206	206	136	136
Volume refrigerator (net)	lt	189	189	188	176	176	175	175	204	204	133	133
Chiller Volume (net)	lt	-	-	-	-	-	-	-	-	-	-	-
Volume Freezer (gross)	lt	84	84	84	38	38	17	17	0	0	17	17
Volume Freezer (net)	lt	72	72	72	38	38	17	17	0	0	17	17
Performance (star rating)		4	4	4	4	4	4	4	-	-	4	4
Energy consumption	kWh/24h	0,715	0,936	1,408	0,622	0,488	0,450	0,573	0,272	0,346	0,414	0,529
Energy consumption	kWh/year	261	342	514	227	178	164	209	99	126	151	193
Freezing Capacity	kg/24h	4	5	4	2	2	2	2	-	-	2	2
Temperature Rise Time (-18°C to -9°C)	mins	660	660	550	960	960	664	664	-	-	720	720
Noise Emission	dB (A)	41	41	42	42	42	43	42	41	39	41	41
Defrost System Type Frigde/Freezer		Automatic / Manual	Automatic / Manual	Automatic / Manual	Automatic / Manual	Automatic / Manual	Automatic / Manual	Automatic / Manual	Automatic	Automatic	Automatic / Manual	Automatic / Manual
Built in		YES	YES	YES	YES	YES	YES	YES	YES	YES	YES	YES
Product dimensions (WxDxH)	mm	540x545x1770	540x545x1770	540x545x1770	540x545x1445	540x545x1445	540x545x1225	540x545x1225	540x545x1225	540x545x1225	540x545x1020	540x545x1020
Packaged dims (WxDxH) (double-wave carton pack) / standard	mm	584x600x1834	584x600x1834	584x600x1834	584x600x1509	584x600x1509	584x600x1289	584x600x1289	584x600x1289	584x600x1289	584x600x1084	584x600x1084
Loading Quantity / 40ft HC	pcs	100	100	100	133	133	160	160	160	160	160	160
Refrigerating Gas		R600a	R600a	R600a	R600a	R600a	R600a	R600a	R600a	R600a	R600a	R600a

BUILT IN												
Model	1900		1400		1500		1450		1700		1650	
Refrigerator Class	1		7		1		8		1		8	
Climatic Class	BGN (16 °C-32°C)	BGT/N (16 °C-43°C)	BGN (16 °C-32°C)		BGN (16°C-32°C)	BGT/N (16°C-43°C)	BGT/SN (10 °C-43°C)	BGST/N (16 °C-38°C)	BGSN (10 °C-32°C)		BGSN (10 °C-32°C)	
Energy Class	A++	A+	A++	A+	A++	A+	A++	A+	A++	A+	A+	A
Volume Total (gross)	lt	162	162	126	126	135	135	109	109	136	136	107
Volume Total (net)	lt	160	160	123	123	134	134	99	99	133	133	93
Volume refrigerator (gross)	lt	162	162	109	109	135	135	0	0	136	136	0
Volume refrigerator (net)	lt	160	160	106	106	134	134	0	0	133	133	0
Chiller Volume (net)	lt	-	-	-	-	-	-	-	-	-	-	-
Volume Freezer (gross)	lt	0	0	17	17	0	0	109	109	0	0	107
Volume Freezer (net)	lt	0	0	17	17	0	0	99	99	0	0	93
Performance (star rating)		-	-	4	4	-	-	4	4	-	-	4
Energy consumption	kWh/24h	0,261	0,343	0,392	0,499	0,255	0,332	0,433	0,534	0,247	0,316	0,484
Energy consumption	kWh/year	95	125	143	182	93	121	158	195	90	115	177
Freezing Capacity	kg/24h	-	-	2	2	-	-	8	8	-	-	9
Temperature Rise Time (-18°C to -9°C)	mins	-	-	650	650	-	-	660	660	-	-	1080
Noise Emission	dB (A)	41	39	41	41	39	41	40	39	44	44	44
Defrost System Type Frigde/Freezer		Automatic	Automatic	Automatic / Manual	Automatic / Manual	Automatic	Automatic	Manual	Manual	Automatic	Automatic	Manual
Built in		YES	YES	YES	YES	YES	YES	YES	YES	YES	YES	YES
Product dimensions (WxDxH)	mm	540x545x1020	540x545x1020	540x545x875	540x545x875	540x545x875	540x545x875	540x545x875	540x545x875	595x548x818	595x548x818	595x548x818
Packaged dims (WxDxH) (double-wave carton pack) / standard	mm	584x600x1084	584x600x1084	584x600x939	584x600x939	584x600x939	584x600x939	584x600x939	584x600x939	659x586x883	659x586x883	659x586x883
Loading Quantity / 40ft HC	pcs	160	160	205	205	205	205	205	205	214	214	214
Refrigerating Gas		R600a	R600a	R600a	R600a	R600a	R600a	R600a	R600a	R600a	R600a	R600a

REFRIGERATORS // SPECIFICATIONS

BUILT IN													
Model	3320				3310		1600	2791E		2795E		2795M	
Refrigerator Class	7				7		7	8		1		1	
Climatic Class	BGN (16°C-32°C)				BGT/SN (10°C-43°C)		BGSN (10°C-32°C)	BGT/SN (10°C-43°C)		BGT/SN (10°C-43°C)		BGT/SN (10°C-43°C)	
Energy Class	A++		A+		A++		A+	A++		A+		A++	
Volume Total (gross)	lt	235	235	235	235	235	120	221	221	303	303	303	303
Volume Total (net)	lt	223	223	216	216	216	115	197	197	300	300	300	300
Volume refrigerator (gross)	lt	160	160	160	160	160	102	0	0	303	303	303	303
Volume refrigerator (net)	lt	158	158	158	158	158	98	0	0	300	300	300	300
Chiller Volume (net)	lt	-	-	-	-	-	-	---	---	---	---	---	---
Volume Freezer (gross)	lt	75	75	75	75	75	18	221	221	-	-	-	-
Volume Freezer (net)	lt	65	65	58	58	58	17	197	197	-	-	-	-
Performance (star rating)		4	4	4	4	4	4	4*	4*	---	---	---	---
Energy consumption	kWh/24h	0,523	0,665	0,584	0,743	0,468	0,638	0,813	0,309	0,397	0,309	0,397	
Energy consumption	kWh/year	191	243	213	271	171	233	297	113	145	113	145	
Freezing Capacity	kg/24h	3	3	2,6	2,6	2	9	9	---	---	---	---	
Temperature Rise Time (-18°C to -9°C)	mins	1140	1140	750	750	626	TBD	540	-	-	-	-	
Noise Emission	dB(A)	41	41	43	43	44	TBD	TBD	TBD	TBD	TBD	TBD	
Defrost System Type Frigde/Freezer		Automatic/Manuel	Automatic/Manuel	Automatic	Automatic	Automatic/Manuel	Automatic	Automatic	Manual	Manual	Manual	Manual	
Built in		YES	YES	YES	YES	YES	YES	YES	YES	YES	YES	YES	
Product dimensions (WxDxH)	mm	540x545x1770	540x545x1770	540x545x1770	540x545x1770	595x548x818	540x545x1770	540x545x1770	540x545x1770	540x545x1770	540x545x1770	540x545x1770	
Packaged dims (WxDxH) (double-wave carton pack) / standard	mm	584x600x1834	584x600x1834	584x600x1834	584x600x1834	659x586x883	584x600x1834	584x600x1834	584x600x1834	584x600x1834	584x600x1834	584x600x1834	
Loading Quantity / 40ft HC	pcs	100	100	100	100	214	100	100	100	100	100	100	
Refrigerating Gas		R600a	R600a	R600a	R600a	R600a	R600a	R600a	R600a	R600a	R600a	R600a	

BUILT IN														
Model	2761M				2761E		2751M		2751E		2750M		2760M	
Refrigerator Class	7				7		7		7		7		7	
Climatic Class	BGN (16°C-32°C)				BGN (16°C-32°C)		BGN (16°C-32°C)		BGN (16°C-32°C)		BGN (16°C-32°C)		BGN (16°C-32°C)	
Energy Class	A++		A+		A++		A+		A++		A+		A++	
Volume Total (gross)	lt	251	251	251	251	245	245	245	245	245	245	251	251	
Volume Total (net)	lt	237	237	237	237	227	227	227	227	235	235	243	243	
Volume refrigerator (gross)	lt	179	179	179	179	146	146	146	146	146	146	179	179	
Volume refrigerator (net)	lt	179	179	179	179	146	146	146	146	146	146	179	179	
Chiller Volume (net)	lt	---	---	---	---	---	---	---	---	---	---	---	---	
Volume Freezer (gross)	lt	72	72	72	72	99	99	99	99	99	99	72	72	
Volume Freezer (net)	lt	58	58	58	58	81	81	81	81	89	89	64	64	
Performance (star rating)		4*	4*	4*	4*	4*	4*	4*	4*	4*	4*	4*	4*	
Energy consumption	kWh/24h	0,547	0,698	0,547	0,698	0,569	0,726	0,569	0,726	0,556	0,709	0,539	0,684	
Energy consumption	kWh/year	200	255	200	255	208	265	208	265	203	259	197	250	
Freezing Capacity	kg/24h	3	3	3	3	3	3	3	3	3	3	3	3	
Temperature Rise Time (-18°C to -9°C)	mins	TBD	TBD	TBD	TBD	TBD	TBD	TBD	TBD	TBD	TBD	TBD	TBD	
Noise Emission	dB(A)	TBD	TBD	TBD	TBD	TBD	TBD	TBD	TBD	TBD	TBD	TBD	TBD	
Defrost System Type Frigde/Freezer		Automatic	Automatic	Automatic	Automatic	Automatic	Automatic	Automatic	Automatic	Automatic	Automatic	Automatic	Automatic	
Built in		YES	YES	YES	YES	YES	YES	YES	YES	YES	YES	YES	YES	
Product dimensions (WxDxH)	mm	540x545x1770	540x545x1770	540x545x1770	540x545x1770	540x545x1770	540x545x1770	540x545x1770	540x545x1770	540x545x1770	540x545x1770	540x545x1770	540x545x1770	
Packaged dims (WxDxH) (double-wave carton pack) / standard	mm	584x600x1834	584x600x1834	584x600x1834	584x600x1834	584x600x1834	584x600x1834	584x600x1834	584x600x1834	584x600x1834	584x600x1834	584x600x1834	584x600x1834	
Loading Quantity / 40ft HC	pcs	100	100	100	100	100	100	100	100	100	100	100	100	
Refrigerating Gas		R600a	R600a	R600a	R600a	R600a	R600a	R600a	R600a	R600a	R600a	R600a	R600a	

DISHWASHERS // SPECIFICATIONS

SEMI-INTEGRATED X&C SERIES 60cm Models	X11	X1A	X12	X1B	X13	X1C	X14	X1D
General Characteristics								
Number of Place Settings	12	12	12	12	12	12	12	12
Number of programs	2	2	3	3	4	4	5	5
Temperatures (°C)	Temperatures (°C)	Temperatures (°C)	Temperatures (°C)	Temperatures (°C)	Temperatures (°C)	Temperatures (°C)	Temperatures (°C)	Temperatures (°C)
Control type	full-electronic	full-electronic	full-electronic	full-electronic	full-electronic	full-electronic	full-electronic	full-electronic
Hidden heating element	Yes	Yes	Yes	Yes	Yes	Yes	Yes	Yes
Filter type	Metal / Plastic	Metal / Plastic	Metal / Plastic	Metal / Plastic	Metal / Plastic	Metal / Plastic	Metal / Plastic	Metal / Plastic
Turbidity sensor	No	No	No	No	No	No	No	No
Drying system	Mini Active/ Super Active	Mini Active/ Super Active	Mini Active/ Super Active	Mini Active/ Super Active	Mini Active/ Super Active	Mini Active/ Super Active	Mini Active/ Super Active	Mini Active/ Super Active
Overflow & leakage protection	Yes	Yes	Yes	Yes	Yes	Yes	Yes	Yes
Heater protection	Yes	Yes	Yes	Yes	Yes	Yes	Yes	Yes
Circulation Pump	Asynchronous	Asynchronous	Asynchronous	Asynchronous	Asynchronous	Asynchronous	Asynchronous	Asynchronous
Programs								
Prewash	No	No	No	No	No	No	No	No
Eco 50°C	Yes	Yes	Yes	Yes	Yes	Yes	Yes	Yes
Intensive 65°C	Yes	Yes	Yes	Yes	Yes	Yes	Yes	Yes
Quick 30' 40°C	No	No	No	No	Yes	Yes	Yes	Yes
Super 50' 65°C	No	No	Yes	Yes	Yes	Yes	Yes	Yes
Super 55' 60°C	No	No	No	No	No	No	No	No
Delicate 40°C	No	No	No	No	No	No	No	No
Normal 55°C	No	No	No	No	No	No	No	No
Auto Delicate 30°C - 50°C	No	No	No	No	No	No	No	No
Auto Normal 50°C - 60°C	No	No	No	No	No	No	No	No
Auto Intensive 60°C - 70°C	No	No	No	No	No	No	No	No
Hygiene 60°C	No	No	No	No	No	No	No	No
Hygiene 70°C	No	No	No	No	No	No	Yes	Yes
Extra Intensive 70°C (Prewash Button + Intensive 65°C)	No	No	No	No	No	No	No	No
Extra Hygiene 70°C (Prewash Button + Hygiene 60°C)	No	No	No	No	No	No	No	No
User Interface								
Start/Pause	Yes	Yes	Yes	Yes	Yes	Yes	Yes	Yes
Prewash button	No	No	No	No	No	No	No	No
DISPLAY (delay start (1-2-3...-19hr), remaining time)	No	Yes	No	Yes	No	Yes	No	Yes
Option button1 (Delay time)	Yes (3hr, 6hr, 9hr)	No	Yes (3hr, 6hr, 9hr)	No	Yes (3hr, 6hr, 9hr)	No	Yes (3hr, 6hr, 9hr)	No
Option button1 (Half load with 1 mode)	Yes	Yes	Yes	Yes	Yes	Yes	Yes	Yes
Half load button (with 3 modes)	No	No	No	No	No	No	No	No
Tablet button	No	No	No	No	No	No	No	No
Rinse-aid indicator	Yes	Yes	Yes	Yes	Yes	Yes	Yes	Yes
Salt indicator	Yes	Yes	Yes	Yes	Yes	Yes	Yes	Yes
Washing cycle indicators	Yes	Yes	Yes	Yes	Yes	Yes	Yes	Yes
Child Lock	No	Yes	No	Yes	No	Yes	No	Yes
Baskets & Accessories								
3rd basket	No	No	No	No	No	No	No	No
Upper basket types [mesh type / peg type]	(o)	(o)	(o)	(o)	(o)	(o)	(o)	(o)
Adjustable upper basket when empty	(o)	(o)	(o)	(o)	(o)	(o)	(o)	(o)
Adjustable upper basket when loaded	(o)	(o)	(o)	(o)	(o)	(o)	(o)	(o)
Number of mug shelves	2 (std) / 4 (o)	2 (std) / 4 (o)	2 (std) / 4 (o)	2 (std) / 4 (o)	2 (std) / 4 (o)	2 (std) / 4 (o)	2 (std) / 4 (o)	2 (std) / 4 (o)
Adjustable mug shelves (peg)	Yes	Yes	Yes	Yes	Yes	Yes	Yes	Yes
Adjustable mug shelves (mesh)	(o)	(o)	(o)	(o)	(o)	(o)	(o)	(o)
Foldable racks on upper basket (peg)	fixed (std) / 2 or 4 or 6 (o)	fixed (std) / 2 or 4 or 6 (o)	fixed (std) / 2 or 4 or 6 (o)	fixed (std) / 2 or 4 or 6 (o)	fixed (std) / 2 or 4 or 6 (o)	fixed (std) / 2 or 4 or 6 (o)	fixed (std) / 2 or 4 or 6 (o)	fixed (std) / 2 or 4 or 6 (o)
Foldable racks on lower basket	(o)	(o)	(o)	(o)	(o)	(o)	(o)	(o)
Wire basket handles	(o)	(o)	(o)	(o)	(o)	(o)	(o)	(o)
Plastic basket handles	(o)	(o)	(o)	(o)	(o)	(o)	(o)	(o)
Removable cutlery basket (Single piece)	(o)	(o)	(o)	(o)	(o)	(o)	(o)	(o)
Removable cutlery basket (Universal)	No	No	No	No	No	No	No	No
Removable cutlery basket (Modular) (2)	(o)	(o)	(o)	(o)	(o)	(o)	(o)	(o)
Removable cutlery basket (Sliding) (3)	(o)	(o)	(o)	(o)	(o)	(o)	(o)	(o)
Multi func. kit (Extra mug shelves + higher rear part on lower basket)	(o)	(o)	(o)	(o)	(o)	(o)	(o)	(o)
Bottle holder on lower basket	(o)	(o)	(o)	(o)	(o)	(o)	(o)	(o)
Wine stem support & Spoon rack on upper basket (2)	(o)	(o)	(o)	(o)	(o)	(o)	(o)	(o)
Top nozzle	No	No	No	No	No	No	No	No
Aquastop external hose	(o)	(o)	(o)	(o)	(o)	(o)	(o)	(o)
Interior light	No	No	No	No	No	No	No	No
Performance (4)								
Noise Level (dB(A))	57/54/52/49/47/45	57/54/52/49/47/45	57/54/52/49/47/45	57/54/52/49/47/45	57/54/52/49/47/45	57/54/52/49/47/45	57/54/52/49/47/45	57/54/52/49/47/45
Energy efficiency class	A++	A++	A++	A++	A++	A++	A++	A++
Cleaning performance	A	A	A	A	A	A	A	A
Drying performance	A	A	A	A	A	A	A	A
Water consumption (lt)	12	12	12	12	12	12	12	12
Annual water consumption (lt/year)	3360	3360	3360	3360	3360	3360	3360	3360
Program duration (min)	165	165	165	165	165	165	165	165
Energy consumption (kWh)	0,90	0,90	0,90	0,90	0,90	0,90	0,90	0,90
Annual energy consumption (kWh/year)	258	258	258	258	258	258	258	258
Voltage (V) / Frequency (Hz)	220-240 / 50	220-240 / 50	220-240 / 50	220-240 / 50	220-240 / 50	220-240 / 50	220-240 / 50	220-240 / 50
Fuse Rating (A)	10	10	10	10	10	10	10	10
Dimensions								
Height (cm)	82,0	82,0	82,0	82,0	82,0	82,0	82,0	82,0
Width (cm)	59,8	59,8	59,8	59,8	59,8	59,8	59,8	59,8
Depth (cm)	57,0	57,0	57,0	57,0	57,0	57,0	57,0	57,0
Height adjustment (+cm)	5	5	5	5	5	5	5	5
Packed dimensions (Height x Width x Depth) (cm)	85,1 x 64,4 x 66,1	85,1 x 64,4 x 66,1	85,1 x 64,4 x 66,1	85,1 x 64,4 x 66,1	85,1 x 64,4 x 66,1	85,1 x 64,4 x 66,1	85,1 x 64,4 x 66,1	85,1 x 64,4 x 66,1
Stacking quantity (pcs)	5	5	5	5	5	5	5	5
Gross/Net weight (kg/5)	43 /41	43 /41	43 /41	43 /41	43 /41	43 /41	43 /41	43 /41
Container loading (40'HC/ 40' 20')	162 /108 /54	162 /108 /54	162 /108 /54	162 /108 /54	162 /108 /54	162 /108 /54	162 /108 /54	162 /108 /54

DISHWASHERS // SPECIFICATIONS

SEMI-INTEGRATED X&C SERIES 60cm Models	X15	X1E	X16	X1F	C21	C31	C41
General Characteristics							
Number of Place Settings	12	12	12	12	12	12/13	12/15
Number of programs	6	6	7	7	6	7	9+
Temperatures (°C)	Temperatures (°C)	Temperatures (°C)	Temperatures (°C)	Temperatures (°C)	Temperatures (°C)	Temperatures (°C)	Temperatures (°C)
Control type	full-electronic	full-electronic	full-electronic	full-electronic	full-electronic	full-electronic	full-electronic
Hidden heating element	Yes	Yes	Yes	Yes	Yes	Yes	Yes
Filter type	Metal / Plastic	Metal / Plastic	Metal / Plastic	Metal / Plastic	Metal / Plastic	Metal / Plastic	Metal / Plastic
Turbidity sensor	No	No	No	No	No	No	Yes
Drying system	Mini Active/ Super Active	Mini Active/ Super Active	Mini Active/ Super Active	Mini Active/ Super Active	Mini Active/ Super Active	Mini Active/ Super Active/ Turbo(1)	Super Active/ Turbo(1)
Overflow & leakage protection	Yes	Yes	Yes	Yes	Yes	Yes	Yes
Heater protection	Yes	Yes	Yes	Yes	Yes	Yes	Yes
Circulation Pump	Asynchronous	Asynchronous	Asynchronous	Asynchronous	Asynchronous	Asynchronous	Asynchronous
Programs							
Prewash	Yes	Yes	Yes	Yes	Yes (separate function button)	Yes (separate function button)	Yes (separate function button)
Eco 50°C	Yes	Yes	Yes	Yes	Yes	Yes	Yes
Intensive 65°C	Yes	Yes	Yes	Yes	Yes	Yes	No
Quick 30' 40°C	Yes	Yes	Yes	Yes	Yes	Yes	Yes
Super 50' 65°C	Yes	Yes	Yes	Yes	Yes	Yes	No
Super 55' 60°C	No	No	No	No	No	No	Yes
Delicate 40°C	No	No	Yes	Yes	No	Yes	No
Normal 55°C	No	No	No	No	No	No	No
Auto Delicate 30°C - 50°C	No	No	No	No	No	No	Yes
Auto Normal 50°C - 60°C	No	No	No	No	No	No	Yes
Auto Intensive 60°C - 70°C	No	No	No	No	No	No	Yes
Hygiene 60°C	No	No	No	No	No	No	Yes
Hygiene 70°C	Yes	Yes	Yes	Yes	No	No	No
Extra Intensive 70°C (Prewash Button + Intensive 65°C)	No	No	No	No	Yes	Yes	No
Extra Hygiene 70°C (Prewash Button + Hygiene 60°C)	No	No	No	No	No	No	Yes
User Interface							
Start/Pause	Yes	Yes	Yes	Yes	Yes	Yes	Yes
Prewash button	No	No	No	No	Yes	Yes	Yes
DISPLAY (delay start (1-2-3...-19hr), remaining time)	No	Yes	No	Yes	No	No	Yes
Option button1 (Delay time)	Yes (3hr, 6hr, 9hr)	No	Yes (3hr, 6hr, 9hr)	No	Yes (3hr, 6hr, 9hr, 12hr)	Yes (3hr, 6hr, 9hr, 12hr)	No
Option button1 (Half load with 1 mode)	Yes	Yes	Yes	Yes	No	No	No
Half load button (with 3 modes)	No	No	No	No	No	Yes	Yes
Tablet button	No	No	No	No	No	No	Yes
Rinse-aid indicator	Yes	Yes	Yes	Yes	Yes	Yes	Yes
Salt indicator	Yes	Yes	Yes	Yes	Yes	Yes	Yes
Washing cycle indicators	Yes	Yes	Yes	Yes	Yes	Yes	Yes
Child Lock	No	Yes	No	Yes	Yes	Yes	Yes
Baskets & Accessories							
3rd basket	No	No	No	No	No	No(12ps), Yes (13ps)	No(12ps), Yes (15ps)
Upper basket types [mesh type / peg type]	(o)	(o)	(o)	(o)	(o)	(o)	(o)
Adjustable upper basket when empty	(o)	(o)	(o)	(o)	(o)	(o)	(o)
Adjustable upper basket when loaded	(o)	(o)	(o)	(o)	(o)	(o)	(o)
Number of mug shelves	2 (std) / 4 (o)	2 (std) / 4 (o)	2 (std) / 4 (o)	2 (std) / 4 (o)	2 (std) / 4 (o)	2 (std) / 4 (o)	2 (std) / 4 (o)
Adjustable mug shelves (peg)	Yes	Yes	Yes	Yes	Yes	Yes	Yes
Adjustable mug shelves (mesh)	(o)	(o)	(o)	(o)	(o)	(o)	(o)
Foldable racks on upper basket (peg)	fixed (std) / 2 or 4 or 6 (o)	fixed (std) / 2 or 4 or 6 (o)	fixed (std) / 2 or 4 or 6 (o)	fixed (std) / 2 or 4 or 6 (o)	fixed (std) / 2 or 4 or 6 (o)	fixed (std) / 2 or 4 or 6 (o)	fixed (std) / 2 or 4 or 6 (o)
Foldable racks on lower basket	(o)	(o)	(o)	(o)	(o)	(o)	(o)
Wire basket handles	(o)	(o)	(o)	(o)	(o)	(o)	(o)
Plastic basket handles	(o)	(o)	(o)	(o)	(o)	(o)	(o)
Removable cutlery basket (Single piece)	(o)	(o)	(o)	(o)	(o)	(o)(12ps) / No(13ps)	(o)(12ps) / No(15ps)
Removable cutlery basket (Universal)	No	No	No	No	No	No(12ps) / (o)(13ps)	No(12ps) / (o)(15ps)
Removable cutlery basket (Modular) (2)	(o)	(o)	(o)	(o)	(o)	(o)	(o)
Removable cutlery basket (Sliding) (3)	(o)	(o)	(o)	(o)	(o)	(o)	(o)(12ps) / No(15ps)
Multi func. kit (Extra mug shelves + higher rear part on lower basket)	(o)	(o)	(o)	(o)	(o)	(o)	(o)
Bottle holder on lower basket	(o)	(o)	(o)	(o)	(o)	(o)	(o)
Wine stem support & Spoon rack on upper basket (2)	(o)	(o)	(o)	(o)	(o)	(o)	(o)
Top nozzle	No	No	No	No	No	(o)(12ps) / Yes(13ps)	(o)(12ps) / Yes(15ps)
Aquastop external hose	(o)	(o)	(o)	(o)	(o)	(o)	(o)
Interior light	No	No	No	No	No	No	(o)
Performance (4)							
Noise Level (dB(A))	57/54/52/49/47/45	57/54/52/49/47/45	57/54/52/49/47/45	57/54/52/49/47/45	57/54/52/49/47/45	54/52/49/47/45	54/52/49/47/45
Energy efficiency class	A++	A++	A++	A++	A++	A++	A++
Cleaning performance	A	A	A	A	A	A	A
Drying performance	A	A	A	A	A	A	A
Water consumption (lt)	12	12	12	12	12	9	9
Annual water consumption (lt/year)	3360	3360	3360	3360	3360	2520	2520
Program duration (min)	165	165	165	165	165	166	166
Energy consumption (kWh)	0.90	0.90	0.90	0.90	0.90	0.90 / 0.91	0.90 / 0.94
Annual energy consumption (kWh/year)	258	258	258	258	258	258 / 261	258 / 267
Voltage (V) / Frequency (Hz)	220-240 / 50	220-240 / 50	220-240 / 50	220-240 / 50	220-240 / 50	220-240 / 50	220-240 / 50
Fuse Rating (A)	10	10	10	10	10	10	10
Dimensions							
Height (cm)	82,0	82,0	82,0	82,0	82,0	82,0	82,0
Width (cm)	59,8	59,8	59,8	59,8	59,8	59,8	59,8
Depth (cm)	57,0	57,0	57,0	57,0	57,0	57,0	57,0
Height adjustment (+cm)	5	5	5	5	5	5	5
Packed dimensions (Height x Width x Depth) (cm)	85,1 x 64,4 x 66,1	85,1 x 64,4 x 66,1	85,1 x 64,4 x 66,1	85,1 x 64,4 x 66,1	85,1 x 64,4 x 66,1	85,1 x 64,4 x 66,1	85,1 x 64,4 x 66,1
Stacking quantity (pcs)	5	5	5	5	5	5	5
Gross/Net weight (kg/5)	43 /41	43 /41	43 /41	43 /41	43 /41	43 /41	43 /41
Container loading (40"HC/ 40' 20")	162 /108 /54	162 /108 /54	162 /108 /54	162 /108 /54	162 /108 /54	162 /108 /54	162 /108 /54

Notes

- (o) : Optional
- (1) : Turbo fan drying system & 3rd basket are default for 15ps models & 13 ps for C31 model
- (2) : Modular cutlery basket for 12 PS must be selected with wine stem support & spoon rack. Also wine stem support & spoon rack can be selected only for mesh type upper basket option.
- (3) : Can be selected for lower basket with fixed type or with 4 foldable wire.
- (4) : Based on the tests performed with Eco 50°C program in accordance with EN 50242.
- (5) : Gros/Net Weights are shown as reference in the table. It should be calculated based on the final product features created from this general spect table.

DISHWASHERS // SPECIFICATIONS

SEMI-INTEGRATED Y SERIES 60cm Models	Y11	Y1A	Y12	Y1B	Y13	Y1C	Y14	Y1D
General Characteristics								
Number of Place Settings	12	12	12	12	12	12	12	12
Number of programs	2	2	3	3	4	4	5	5
Temperatures (°C)	50-65	50-65	50-65	50-65	40-50-65	40-50-65	40-50-65-70	40-50-65-70
Control type	full-electronic	full-electronic	full-electronic	full-electronic	full-electronic	full-electronic	full-electronic	full-electronic
Hidden heating element	Yes	Yes	Yes	Yes	Yes	Yes	Yes	Yes
Filter type	Metal / Plastic	Metal / Plastic	Metal / Plastic	Metal / Plastic	Metal / Plastic	Metal / Plastic	Metal / Plastic	Metal / Plastic
Turbidity sensor	No	No	No	No	No	No	No	No
Drying system	Mini Active/ Super Active	Mini Active/ Super Active	Mini Active/ Super Active	Mini Active/ Super Active	Mini Active/ Super Active	Mini Active/ Super Active	Mini Active/ Super Active	Mini Active/ Super Active
Overflow & leakage protection	Yes	Yes	Yes	Yes	Yes	Yes	Yes	Yes
Heater protection	Yes	Yes	Yes	Yes	Yes	Yes	Yes	Yes
Circulation Pump	Asynchronous	Asynchronous	Asynchronous	Asynchronous	Asynchronous	Asynchronous	Asynchronous	Asynchronous
Programs								
Prewash	No	No	No	No	No	No	No	No
Eco	Yes	Yes	Yes	Yes	Yes	Yes	Yes	Yes
Intensive 65°C	Yes	Yes	Yes	Yes	Yes	Yes	Yes	Yes
Steam Wash	No	No	No	No	No	No	No	No
Quick 30' 40°C	No	No	No	No	Yes	Yes	Yes	Yes
Super 50' 65°C	No	No	Yes	Yes	Yes	Yes	Yes	Yes
Delicate 40°C	No	No	No	No	No	No	Yes	Yes
Daily 60°C	No	No	No	No	No	No	No	No
Normal 55°C	No	No	No	No	No	No	No	No
Auto Delicate 30°C - 50°C	No	No	No	No	No	No	No	No
Auto Normal 50°C - 60°C	No	No	No	No	No	No	No	No
Auto Intensive 60°C - 70°C	No	No	No	No	No	No	No	No
User Interface								
Start/Pause	Yes	Yes	Yes	Yes	Yes	Yes	Yes	Yes
DISPLAY (delay start (1-2-3-...-19hr), remaining time)	No	Yes	No	Yes	No	Yes	No	Yes
Delay timer	Yes (3hr,6hr,9hr)	Yes	Yes (3hr,6hr,9hr)	Yes	Yes (3hr,6hr,9hr)	Yes	Yes (3hr,6hr,9hr)	Yes
Program selection button	Yes	Yes	Yes	Yes	Yes	Yes	Yes	Yes
Half load (with 1 mode)	Yes	Yes	Yes	Yes	Yes	Yes	Yes	Yes
Half load button (with 3 modes)	No	No	No	No	No	No	No	No
Tablet button	No	Yes	No	Yes	No	Yes	No	Yes
Extra Hygiene option	No	Yes	No	Yes	No	Yes	No	Yes
Extra Rinse option	No	Yes	No	Yes	No	Yes	No	Yes
Extra Dry option	No	Yes	No	Yes	No	Yes	No	Yes
Rinse-aid indicator	Yes	Yes	Yes	Yes	Yes	Yes	Yes	Yes
Salt indicator	Yes	Yes	Yes	Yes	Yes	Yes	Yes	Yes
Washing cycle indicators	Yes	Yes	Yes	Yes	Yes	Yes	Yes	Yes
Child Lock	No	Yes	No	Yes	No	Yes	No	Yes
Baskets & Accessories								
3rd basket	No	No	No	No	No	No	No	No
Upper basket types [mesh type / peg type]	(o)	(o)	(o)	(o)	(o)	(o)	(o)	(o)
Adjustable upper basket when empty	(o)	(o)	(o)	(o)	(o)	(o)	(o)	(o)
Adjustable upper basket when loaded	(o)	(o)	(o)	(o)	(o)	(o)	(o)	(o)
Number of mug shelves	2 (std) / 4 (o)	2 (std) / 4 (o)	2 (std) / 4 (o)	2 (std) / 4 (o)	2 (std) / 4 (o)	2 (std) / 4 (o)	2 (std) / 4 (o)	2 (std) / 4 (o)
Adjustable mug shelves (peg)	Yes	Yes	Yes	Yes	Yes	Yes	Yes	Yes
Adjustable mug shelves (mesh)	(o)	(o)	(o)	(o)	(o)	(o)	(o)	(o)
Foldable racks on upper basket (peg)	fixed (std) / 2 or 4 or 6 (o)	fixed (std) / 2 or 4 or 6 (o)	fixed (std) / 2 or 4 or 6 (o)	fixed (std) / 2 or 4 or 6 (o)	fixed (std) / 2 or 4 or 6 (o)	fixed (std) / 2 or 4 or 6 (o)	fixed (std) / 2 or 4 or 6 (o)	fixed (std) / 2 or 4 or 6 (o)
Foldable racks on lower basket	(o)	(o)	(o)	(o)	(o)	(o)	(o)	(o)
Wire basket handles	(o)	(o)	(o)	(o)	(o)	(o)	(o)	(o)
Plastic basket handles	(o)	(o)	(o)	(o)	(o)	(o)	(o)	(o)
Removable cutlery basket (Single piece)	(o)	(o)	(o)	(o)	(o)	(o)	(o)	(o)
Removable cutlery basket (Universal)	No	No	No	No	No	No	No	No
Removable cutlery basket (Modular) (2)	(o)	(o)	(o)	(o)	(o)	(o)	(o)	(o)
Removable cutlery basket (Sliding) (3)	(o)	(o)	(o)	(o)	(o)	(o)	(o)	(o)
Multi func. kit (Extra mug shelves + higher rear part on lower basket)	(o)	(o)	(o)	(o)	(o)	(o)	(o)	(o)
Bottle holder on lower basket	(o)	(o)	(o)	(o)	(o)	(o)	(o)	(o)
Wine stem support & Spoon rack on upper basket (2)	(o)	(o)	(o)	(o)	(o)	(o)	(o)	(o)
Top nozzle	No	No	No	No	No	No	No	No
Aquastop external hose	(o)	(o)	(o)	(o)	(o)	(o)	(o)	(o)
Interior light	No	No	No	No	No	No	No	No
Performance (4)								
Noise Level (dB(A))	57/54/52/49/47/45	57/54/52/49/47/45	57/54/52/49/47/45	57/54/52/49/47/45	57/54/52/49/47/45	57/54/52/49/47/45	57/54/52/49/47/45	57/54/52/49/47/45
Energy efficiency class	A++	A++	A++	A++	A++	A++	A++	A++
Cleaning performance	A	A	A	A	A	A	A	A
Drying performance	A	A	A	A	A	A	A	A
Water consumption (lt)	12	12	12	12	12	12	12	12
Annual water consumption (lt/year)	3360	3360	3360	3360	3360	3360	3360	3360
Program duration (min)	165	165	165	165	165	165	165	165
Energy consumption (kWh)	0,90	0,90	0,90	0,90	0,90	0,90	0,90	0,90
Annual energy consumption (kWh/year)	258	258	258	258	258	258	258	258
Voltage (V) / Frequency (Hz)	220-240 / 50	220-240 / 50	220-240 / 50	220-240 / 50	220-240 / 50	220-240 / 50	220-240 / 50	220-240 / 50
Fuse Rating (A)	10	10	10	10	10	10	10	10
Dimensions								
Height (cm)	82,0	82,0	82,0	82,0	82,0	82,0	82,0	82,0
Width (cm)	59,8	59,8	59,8	59,8	59,8	59,8	59,8	59,8
Depth (cm)	57,0	57,0	57,0	57,0	57,0	57,0	57,0	57,0
Height adjustment (+cm)	5	5	5	5	5	5	5	5
Packed dimensions (Height x Width x Depth) (cm)	85,1 x 64,4 x 66,1	85,1 x 64,4 x 66,1	85,1 x 64,4 x 66,1	85,1 x 64,4 x 66,1	85,1 x 64,4 x 66,1	85,1 x 64,4 x 66,1	85,1 x 64,4 x 66,1	85,1 x 64,4 x 66,1
Stacking quantity (pcs)	5	5	5	5	5	5	5	5
Gross/Net weight (kg/5)	43 /41	43 /41	43 /41	43 /41	43 /41	43 /41	43 /41	43 /41
Container loading (40'/HC/ 40'/ 20')	162 /108 /54	162 /108 /54	162 /108 /54	162 /108 /54	162 /108 /54	162 /108 /54	162 /108 /54	162 /108 /54

DISHWASHERS//SPECIFICATIONS

SEMI-INTEGRATED Y SERIES 60cm Models	Y15	Y1E	Y1F	Y21	Y22	Y23	Y24
General Characteristics							
Number of Place Settings	12	12	12	12/15	12/15	12/15	12/15
Number of programs	6	6	7	6	7	8	9
Temperatures (°C)	40-50-65-70	40-50-65-70	40-50-65-70	40-50-65	40-50-55-65	40-50-55-60-70	Auto-30-40-50-55-60-70
Control type	full-electronic	full-electronic	full-electronic	full-electronic	full-electronic	full-electronic	full-electronic
Hidden heating element	Yes	Yes	Yes	Yes	Yes	Yes	Yes
Filter type	Metal / Plastic	Metal / Plastic	Metal / Plastic	Metal / Plastic	Metal / Plastic	Metal / Plastic	Metal / Plastic
Turbidity sensor	No	No	No	No	No	No	Yes
Drying system	Mini Active/ Super Active	Mini Active/ Super Active	Mini Active/ Super Active	Super Active/ Turbo(1)	Super Active/ Turbo(1)	Super Active/ Turbo(1)	Super Active/ Turbo(1)
Overflow & leakage protection	Yes	Yes	Yes	Yes	Yes	Yes	Yes
Heater protection	Yes	Yes	Yes	Yes	Yes	Yes	Yes
Circulation Pump	Asynchronous	Asynchronous	Asynchronous	Asynchronous	Asynchronous	Asynchronous	Asynchronous
Programs							
Prewash	Yes	Yes	Yes	Yes	Yes	Yes	Yes
Eco	Yes	Yes	Yes	Yes	Yes	Yes	Yes
Intensive 65°C	Yes	Yes	Yes	Yes	Yes	Yes	No
Steam Wash	No	No	No	No	No	No	Yes
Quick 30' 40°C	Yes	Yes	Yes	Yes	Yes	Yes	Yes
Super 50' 65°C	Yes	Yes	Yes	Yes	Yes	Yes	Yes
Delicate 40°C	Yes	Yes	Yes	Yes	Yes	Yes	No
Daily 60°C	No	No	Yes	No	Yes	Yes	Yes
Normal 55°C	No	No	No	No	Yes	Yes	No
Auto Delicate 30°C - 50°C	No	No	No	No	No	No	Yes
Auto Normal 50°C - 60°C	No	No	No	No	No	No	Yes
Auto Intensive 60°C - 70°C	No	No	No	No	No	No	Yes
User Interface							
Start/Pause	Yes	Yes	Yes	Yes	Yes	Yes	Yes
DISPLAY (delay start (1-2-3-...-19hr), remaining time)	No	Yes	Yes	Yes	Yes	Yes	Yes
Delay timer	Yes (3hr,6hr,9hr)	Yes	Yes	Yes	Yes	Yes	Yes
Program selection button	Yes	Yes	Yes	Yes	Yes	Yes	Yes
Half load (with 1 mode)	Yes	Yes	Yes	No	No	No	No
Half load button (with 3 modes)	No	No	No	Yes	Yes	Yes	Yes
Tablet button	No	Yes	Yes	Yes	Yes	Yes	Yes
Extra Hygiene option	No	Yes	Yes	Yes	Yes	Yes	Yes
Extra Rinse option	No	Yes	Yes	Yes	Yes	Yes	Yes
Extra Dry option	No	Yes	Yes	Yes	Yes	Yes	Yes
Rinse-aid indicator	Yes	Yes	Yes	Yes	Yes	Yes	Yes
Salt indicator	Yes	Yes	Yes	Yes	Yes	Yes	Yes
Washing cycle indicators	Yes	Yes	Yes	Yes	Yes	Yes	Yes
Child Lock	No	Yes	Yes	Yes	Yes	Yes	Yes
Baskets & Accessories							
3rd basket	No	No	No	No(12ps), Yes (15ps)	No(12ps), Yes (15ps)	No(12ps), Yes (15ps)	No(12ps), Yes (15ps)
Upper basket types [mesh type / peg type]	(o)	(o)	(o)	(o)	(o)	(o)	(o)
Adjustable upper basket when empty	(o)	(o)	(o)	(o)	(o)	(o)	(o)
Adjustable upper basket when loaded	(o)	(o)	(o)	(o)	(o)	(o)	(o)
Number of mug shelves	2 (std) / 4 (o)	2 (std) / 4 (o)	2 (std) / 4 (o)	2 (std) / 4 (o)	2 (std) / 4 (o)	2 (std) / 4 (o)	2 (std) / 4 (o)
Adjustable mug shelves (peg)	Yes	Yes	Yes	Yes	Yes	Yes	Yes
Adjustable mug shelves (mesh)	(o)	(o)	(o)	(o)	(o)	(o)	(o)
Foldable racks on upper basket (peg)	fixed (std) / 2 or 4 or 6 (o)	fixed (std) / 2 or 4 or 6 (o)	fixed (std) / 2 or 4 or 6 (o)	fixed (std) / 2 or 4 or 6 (o)	fixed (std) / 2 or 4 or 6 (o)	fixed (std) / 2 or 4 or 6 (o)	fixed (std) / 2 or 4 or 6 (o)
Foldable racks on lower basket	(o)	(o)	(o)	(o)	(o)	(o)	(o)
Wire basket handles	(o)	(o)	(o)	(o)	(o)	(o)	(o)
Plastic basket handles	(o)	(o)	(o)	(o)	(o)	(o)	(o)
Removable cutlery basket (Single piece)	(o)	(o)	(o)	(o)(12ps) / No(15ps)	(o)(12ps) / No(15ps)	(o)(12ps) / No(15ps)	(o)(12ps) / No(15ps)
Removable cutlery basket (Universal)	No	No	No	No(12ps) / (o)(15ps)	No(12ps) / (o)(15ps)	No(12ps) / (o)(15ps)	No(12ps) / (o)(15ps)
Removable cutlery basket (Modular) (2)	(o)	(o)	(o)	(o)	(o)	(o)	(o)
Removable cutlery basket (Sliding) (3)	(o)	(o)	(o)	(o)(12ps) / No(15ps)	(o)(12ps) / No(15ps)	(o)(12ps) / No(15ps)	(o)(12ps) / No(15ps)
Multi func. kit (Extra mug shelves + higher rear part on lower basket)	(o)	(o)	(o)	(o)	(o)	(o)	(o)
Bottle holder on lower basket	(o)	(o)	(o)	(o)	(o)	(o)	(o)
Wine stem support & Spoon rack on upper basket (2)	(o)	(o)	(o)	(o)	(o)	(o)	(o)
Top nozzle	No	No	No	(o)(12ps) / Yes(15ps)	(o)(12ps) / Yes(15ps)	(o)(12ps) / Yes(15ps)	(o)(12ps) / Yes(15ps)
Aquastop external hose	(o)	(o)	(o)	(o)	(o)	(o)	(o)
Interior light	No	No	No	(o)	(o)	(o)	(o)
Performance (4)							
Noise Level (dB(A))	57/54/52/49/47/45	57/54/52/49/47/45	57/54/52/49/47/45	57/54/52/49/47/45	54/52/49/47/45	54/52/49/47/45	54/52/49/47/45
Energy efficiency class	A++	A++	A++	A++	A++	A++	A++
Cleaning performance	A	A	A	A	A	A	A
Drying performance	A	A	A	A	A	A	A
Water consumption (lt)	12	12	12	9	9	9	9
Annual water consumption (lt/year)	3360	3360	3360	2520	2520	2520	2520
Program duration (min)	165	165	165	171	171	171	171
Energy consumption (kWh)	0,90	0,90	0,90	0,90 / 0,94	0,90 / 0,94	0,90 / 0,94	0,90 / 0,94
Annual energy consumption (kWh/year)	258	258	258	258 / 267	258 / 267	258 / 267	258 / 267
Voltage (V) / Frequency (Hz)	220-240 / 50	220-240 / 50	220-240 / 50	220-240 / 50	220-240 / 50	220-240 / 50	220-240 / 50
Fuse Rating (A)	10	10	10	10	10	10	10
Dimensions							
Height (cm)	82,0	82,0	82,0	82,0	82,0	82,0	82,0
Width (cm)	59,8	59,8	59,8	59,8	59,8	59,8	59,8
Depth (cm)	57,0	57,0	57,0	57,0	57,0	57,0	57,0
Height adjustment (+cm)	5	5	5	5	5	5	5
Packed dimensions (Height x Width x Depth) (cm)	85,1 x 64,4 x 66, 1	85,1 x 64,4 x 66, 1	85,1 x 64,4 x 66, 1	85,1 x 64,4 x 66, 1	85,1 x 64,4 x 66, 1	85,1 x 64,4 x 66, 1	85,1 x 64,4 x 66, 1
Stacking quantity (pcs)	5	5	5	5	5	5	5
Gross/Net weight (kg/5)	43 /41	43 /41	43 /41	43 /41	43 /41	43 /41	43 /41
Container loading (40'HQ/ 40' 20')	162 /108 /54	162 /108 /54	162 /108 /54	162 /108 /54	162 /108 /54	162 /108 /54	162 /108 /54

Notes

- (o) : Optional
- (1) : Turbo fan drying system & 3rd basket are default for 15ps models
- (2) : Modular cutlery basket for 12 PS must be selected with wine stem support & spoon rack. Also wine stem support & spoon rack can be selected only for mesh type upper basket option.
- (3) : Can be selected for lower basket with fixed type or with 4 foldable wire.
- (4) : Based on the tests performed with Eco program in accordance with EN 50242.
- (5) : Gros/Net Weights are shown as reference in the table. It should be calculated based on the final product features created from this general spect table.

DISHWASHERS // SPECIFICATIONS

SEMI-INTEGRATED T SERIES 60cm Models	T11	T12	T13	T21	T24	T25
General Characteristics						
Number of Place Settings	12	12	12	12/15	12/15	14
Number of programs	3	4	6	8	8	8
Temperatures (°C)	50-65	40-50-65	40-50-65	Auto-30-40-50-60-70	Auto-30-40-50-60-70	Auto-30-40-50-60-70
Control type	full-electronic	full-electronic	full-electronic	full-electronic	full-electronic	full-electronic
Hidden heating element	Yes	Yes	Yes	Yes	Yes	Yes
Filter type	Metal / Plastic	Metal / Plastic	Metal / Plastic	Metal / Plastic	Metal	Metal
Turbidity sensor	No	No	No	Yes	Yes	Yes
Drying system	Mini Active/ Super Active	Mini Active/ Super Active	Mini Active/ Super Active	Super Active/ Turbo(1)	Turbo	Turbo
Overflow & leakage protection	Yes	Yes	Yes	Yes	Yes	Yes
Heater protection	Yes	Yes	Yes	Yes	Yes	Yes
Circulation Pump	Asynchronous	Asynchronous	Asynchronous	Asynchronous	BLDC	BLDC
Auto Door Technology	No	No	No	No	Yes	Yes
Water Box Technology	No	No	No	No	No	Yes
Triple Wash	No	No	No	No	No	(o)
Direct Wash	No	No	No	No	No	(o)
Programs						
Prewash	No	No	Yes	Yes	No	No
Mini 18'	No	No	No	No	Yes	Yes
Eco 50°C	Yes	Yes	Yes	Yes	Yes	Yes
Intensive 65°C	Yes	Yes	Yes	No	No	No
Quick 30' 40°C	No	Yes	Yes	Yes	Yes	Yes
Super 50' 65 °C	Yes	Yes	Yes	Yes	Yes	Yes
Delicate 40°C	No	No	Yes	No	No	No
Daily 60°C	No	No	No	Yes	No	No
Auto Delicate 30°C - 50°C	No	No	No	Yes	Yes	Yes
Auto Normal 50°C - 60°C	No	No	No	Yes	No	No
Auto Intensive 60°C - 70°C	No	No	No	Yes	Yes (50°C-70°C)	Yes (50°C-70°C)
Hygiene 60°C	No	No	No	No	No	No
Hygiene 70°C	No	No	No	No	Yes	Yes
Dual Pro Wash 60°C	No	No	No	No	Yes	Yes
Extra Intensive 70°C (Prewash Button + Intensive 65°C)	No	No	No	No	No	No
Extra Hygiene 70°C (Prewash Button + Hygiene 60°C)	No	No	No	No	No	No
User Interface						
Start/Pause	Yes	Yes	Yes	Yes	Yes	Yes
DISPLAY (delay start (1-2-3-...-24hr), remaining time)	No	Yes	Yes	Yes	Yes	Yes
Program selection button	Yes	Yes	Yes	Yes	Yes	Yes
Delay timer button	No	Yes	Yes	Yes	Yes	Yes
Hygiene button	No	No	Yes	Yes	No	No
Tablet button	No	No	Yes	Yes	Yes	Yes
Half load button (1 mode)	Yes	Yes	Yes	No	No	No
Half load button (with 3 modes)	No	No	No	Yes	Yes	Yes
Energy Save button	No	No	No	No	Yes	Yes
Extra Rinse option	No	No	No	Yes	No	No
Extra Dry option	No	No	No	Yes	No	No
Extra Silent option	No	No	No	No	Yes	Yes
Extra Fast option	No	No	No	No	Yes	Yes
Rinse-aid indicator	Yes	Yes	Yes	Yes	Yes	Yes
Salt indicator	Yes	Yes	Yes	Yes	Yes	Yes
Washing cycle indicators	Yes	Yes	Yes	Yes	Yes	Yes
Child Lock	Yes	Yes	Yes	Yes	Yes	Yes
Baskets & Accessories						
3rd basket	No	No	No	No(12ps), Yes (15ps)	No(12ps), Yes (15ps)	Yes (14ps)
Upper basket types [mesh type / peg type]	(o)	(o)	(o)	(o)	(o)	Peg
Adjustable upper basket when empty	(o)	(o)	(o)	(o)	(o)	Yes
Adjustable upper basket when loaded	(o)	(o)	(o)	(o)	(o)	(o)
Number of mug shelves	2 (std) / 4 (o)	2 (std) / 4 (o)	2 (std) / 4 (o)	2 (std) / 4 (o)	2 (std) / 4 (o)	2 (std) / 4 (o)
Adjustable mug shelves (peg)	Yes	Yes	Yes	Yes	Yes	Yes
Adjustable mug shelves (mesh)	(o)	(o)	(o)	(o)	(o)	No
Foldable racks on upper basket (peg)	fixed (std) / 2 or 4 or 6 (o)	fixed (std) / 2 or 4 or 6 (o)	fixed (std) / 2 or 4 or 6 (o)	fixed (std) / 2 or 4 or 6 (o)	fixed (std) / 2 or 4 or 6 (o)	4 or 6 (o)
Foldable racks on lower basket	(o)	(o)	(o)	(o)	(o)	Yes
Wire basket handles	(o)	(o)	(o)	(o)	(o)	No
Plastic basket handles	(o)	(o)	(o)	(o)	(o)	Yes
Removable cutlery basket (Single piece)	(o)	(o)	(o)	(o)(12ps) / No(15ps)	(o)(12ps) / No(15ps)	No
Removable cutlery basket (Universal)	No	No	No	No(12ps) / (o)(15ps)	No(12ps) / (o)(15ps)	(o)
Removable cutlery basket (Modular) (2)	(o)	(o)	(o)	(o)	(o)	(o)
Removable cutlery basket (Sliding) (3)	(o)	(o)	(o)	(o)(12ps) / No(15ps)	(o)(12ps) / No(15ps)	No
Multi func. kit (Extra mug shelves + higher rear part on lower basket)	(o)	(o)	(o)	(o)	(o)	(o)
Bottle holder on lower basket	(o)	(o)	(o)	(o)	(o)	(o)
Wine stem support & Spoon rack on upper basket (2)	(o)	(o)	(o)	(o)	(o)	(o)
Top nozzle	No	No	No	(o)(12ps) / Yes(15ps)	(o)(12ps) / Yes(15ps)	Yes
Aquastop external hose	(o)	(o)	(o)	(o)	(o)	(o)
Interior light	No	No	No	(o)	(o)	No
Performance (4)						
Noise Level (dB(A))	57/54/52/49/47/45	57/54/52/49/47/45	57/54/52/49/47/45	54/52/49/47/45	46 (12ps), 44 (15ps)	44
Energy efficiency class	A++	A++	A++	A++	A+++	A+++%20
Cleaning performance	A	A	A	A	A	A
Drying performance	A	A	A	A	A	A
Water consumption (lt)	12	12	12	9	9	9
Annual water consumption (lt/year)	3360	3360	3360	2520	2520	2520
Program duration (min)	169	169	169	164	201	207
Energy consumption (kWh)	0.90	0.90	0.90	0.90 / 0.94	0.79 / 0.84	0.66
Annual energy consumption (kWh/year)	258	258	258	258 / 267	225 / 239	189
Voltage (V) / Frequency (Hz)	220-240 / 50	220-240 / 50	220-240 / 50	220-240 / 50	220-240 / 50	220-240 / 50
Fuse Rating (A)	10	10	10	10	10	10
Dimensions						
Height (cm)	82,0	82,0	82,0	82,0	82,0	82,0
Width (cm)	59,8	59,8	59,8	59,8	59,8	59,8
Depth (cm)	57,0	57,0	57,0	57,0	57,0	57,0
Height adjustment (+cm)	5	5	5	5	5	5
Packed dimensions (Height x Width x Depth) (cm)	85,1 x 64,4 x 66,1	85,1 x 64,4 x 66,1	85,1 x 64,4 x 66,1	85,1 x 64,4 x 66,1	85,1 x 64,4 x 66,1	85,1 x 64,4 x 66,1
Stacking quantity (pcs)	5	5	5	5	5	5
Gross/Net weight (kg/5)	43 /41	43 /41	43 /41	43 /41	43 /41	43 /41
Container loading (40'HC/ 40' 20')	162 /108 /54	162 /108 /54	162 /108 /54	162 /108 /54	162 /108 /54	162 /108 /54

Notes

- (o) : Optional
- (1) : Turbo fan drying system & 3rd basket are default for 15ps models
- (2) : Modular cutlery basket for 12 PS must be selected with wine stem support & spoon rack. Also wine stem support & spoon rack can be selected only for mesh type upper basket option.
- (3) : Can be selected for lower basket with fixed type or with 4 foldable wire.
- (4) : Based on the tests performed with Eco 50°C program in accordance with EN 50242.
- (5) : Gros/Net Weights are shown as reference in the table. It should be calculated based on the final product features created from this general spect table.

DISHWASHERS//SPECIFICATIONS

SEMI-INTEGRATED T3X (LED) SERIES 60cm Models	T31	T32	T34	T35
General Characteristics				
Number of Place Settings	12/15	12/15	12/15	14
Number of programs	6	8	8	8
Temperatures (°C)	Auto-30-40-50-60-70	Auto-30-40-50-60-70	Auto-30-40-50-60-70	Auto-30-40-50-60-70
Control type	full-electronic	full-electronic	full-electronic	full-electronic
Hidden heating element	Yes	Yes	Yes	Yes
Filter type	Metal / Plastic	Metal / Plastic	Metal	Metal
Turbidity sensor	Yes	Yes	Yes	Yes
Drying system	Super Active/ Turbo(1)	Super Active/ Turbo(1)	Turbo	Turbo
Overflow & leakage protection	Yes	Yes	Yes	Yes
Heater protection	Yes	Yes	Yes	Yes
Circulation Pump	Asynchronous	Asynchronous	BLDC	BLDC
Auto Door Technology	No	No	Yes	Yes
Water Box Technology	No	No	No	Yes
Triple Wash	(o)	(o)	(o)	(o)
Direct Wash	(o)	(o)	(o)	(o)
Programs				
Prewash	Yes	Yes	No	No
Eco 50°C	Yes	Yes	Yes	Yes
Mini 18'	Yes	Yes	Yes	Yes
Quick 30' 40°C	Yes	Yes	Yes	Yes
Super 50' 65°C	Yes	Yes	Yes	Yes
Dual Pro Wash 60°C	No	No	Yes	Yes
Hygiene 70°C	No	No	Yes	Yes
Auto Delicate 30°C - 50°C	No	Yes	Yes	Yes
Auto Normal 50°C - 60°C	No	Yes	No	No
Auto Intensive 60°C - 70°C	Yes	Yes	Yes (50°C - 70°C)	Yes (50°C - 70°C)
User Interface				
Start/Pause button	Yes	Yes	Yes	Yes
Program button	Yes	Yes	Yes	Yes
DISPLAY (delay start (1-2-3-...-24hr), remaining time)	Yes	Yes	Yes	Yes
Delay timer button	Yes	Yes	Yes	Yes
Tablet option	Yes	Yes	Yes	Yes
Half load option (with 3 modes)	Yes	Yes	Yes	Yes
Energy Save option	No	No	Yes	Yes
Extra Hygiene option	Yes	Yes	No	No
Extra Dry option	Yes	Yes	No	No
Extra Silent option	No	No	Yes	Yes
Extra Fast option	No	No	Yes	Yes
Rinse-aid indicator	Yes	Yes	Yes	Yes
Salt indicator	Yes	Yes	Yes	Yes
Washing cycle indicators	Yes	Yes	Yes	Yes
Child Lock	Yes	Yes	Yes	Yes
Baskets & Accessories				
3rd basket	No(12ps), Yes (15ps)	No(12ps), Yes (15ps)	No(12ps), Yes (15ps)	Yes
Upper basket types [mesh type / peg type]	(o)	(o)	(o)	Peg
Adjustable upper basket when empty	(o)	(o)	(o)	Yes
Adjustable upper basket when loaded	(o)	(o)	(o)	(o)
Number of mug shelves	2 (std) / 4 (o)	2 (std) / 4 (o)	2 (std) / 4 (o)	2 (std) / 4 (o)
Adjustable mug shelves (peg)	Yes	Yes	Yes	Yes
Adjustable mug shelves (mesh)	(o)	(o)	(o)	No
Foldable racks on upper basket (peg)	fixed (std) / 2 or 4 or 6 (o)	fixed (std) / 2 or 4 or 6 (o)	fixed (std) / 2 or 4 or 6 (o)	4 or 6 (o)
Foldable racks on lower basket	(o)	(o)	(o)	Yes
Wire basket handles	(o)	(o)	(o)	No
Plastic basket handles	(o)	(o)	(o)	Yes
Removable cutlery basket (Single piece)	(o)(12ps) / No(15ps)	(o)(12ps) / No(15ps)	(o)(12ps) / No(15ps)	No
Removable cutlery basket (Universal)	No(12ps) / (o)(15ps)	No(12ps) / (o)(15ps)	No(12ps) / (o)(15ps)	(o)
Removable cutlery basket (Modular) (2)	(o)	(o)	(o)	(o)
Removable cutlery basket (Sliding) (3)	(o)(12ps)/No(15ps)	(o)(12ps)/No(15ps)	(o)(12ps)/No(15ps)	No
Multi func. kit (Extra mug shelves + higher rear part on lower basket)	(o)	(o)	(o)	(o)
Bottle holder on lower basket	(o)	(o)	(o)	(o)
Wine stem support & Spoon rack on upper basket (2)	(o)	(o)	(o)	(o)
Top nozzle	(o)(12ps) / Yes(15ps)	(o)(12ps) / Yes(15ps)	(o)(12ps) / Yes(15ps)	Yes
Aquastop external hose	(o)	(o)	(o)	(o)
Interior light	(o)	(o)	(o)	No
Performance (4)				
Noise Level (dB(A))	54/52/49/47/45	54/52/49/47/45	46 (12ps), 44 (15ps)	44
Energy efficiency class	A++	A++	A+++	A+++ -9620
Cleaning performance	A	A	A	A
Drying performance	A	A	A	A
Water consumption (lt)	9	9	9	9
Annual water consumption (lt/year)	2520	2520	2520	2520
Program duration (min)	164	164	201	207
Energy consumption (kWh)	0.90 / 0.94	0.90 / 0.94	0.79 / 0.84	0.66
Annual energy consumption (kWh/year)	258 / 267	258 / 267	225 / 239	189
Voltage (V) / Frequency (Hz)	220-240 / 50	220-240 / 50	220-240 / 50	220-240 / 50
Fuse Rating (A)	10	10	10	10
Dimensions				
Height (cm)	82,0	82,0	82,0	82,0
Width (cm)	59,8	59,8	59,8	59,8
Depth (cm)	57,0	57,0	57,0	57,0
Height adjustment (+cm)	5	5	5	5
Packed dimensions (Height x Width x Depth) (cm)	85,1 x 64,4 x 66,1	85,1 x 64,4 x 66,1	85,1 x 64,4 x 66,1	85,1 x 64,4 x 66,1
Stacking quantity (pcs)	5	5	5	5
Gross/Net weight (kg)(5)	43 /41	43 /41	43 /41	43 /41
Container loading (40'HIC/ 40' 20")	162 /108 /54	162 /108 /54	162 /108 /54	162 /108 /54

(o) : Optional
 (1) : Turbo fan drying system & 3rd basket are default for 15ps models
 (2) : Modular cutlery basket for 12 PS must be selected with wine stem support & spoon rack. Also wine stem support & spoon rack can be selected only for mesh type upper basket option.
 (3) : Can be selected for lower basket with fixed type or with 4 foldable wire.
 (4) : Based on the tests performed with Eco 50°C program in accordance with EN 50242.
 (5) : Gros/Net Weights are shown as reference in the table. It should be calculated based on the final product features created from this general spect table.

DISHWASHERS // SPECIFICATIONS

FULLY-INTEGRATED D SERIES 60cm Models	D13	D21	D41	D51	D52	D53
General Characteristics						
Number of Place Settings	12	12	12/15	12	12/15	15
Number of programs	4	5	9+	6	8+	8+
Temperatures (°C)	50-65	40-50-65-70	Auto-30-40-50-60-70	40-50-65	Auto-30-40-50-60-70	Auto-30-40-50-60-70
Control type	full-electronic	full-electronic	full-electronic	Touch control	Touch control	Touch control
Hidden heating element	Yes	Yes	Yes	Yes	Yes	Yes
Filter type	Metal / Plastic	Metal / Plastic	Metal / Plastic	Metal / Plastic	Metal / Plastic	Metal
Turbidity sensor	No	No	Yes	No	Yes	Yes
Drying system	Mini Active/ Super Active	Mini Active/ Super Active	Super Active/ Turbo(1)	Mini Active/ Super Active	Super Active/ Turbo(1)	Turbo
Overflow & leakage protection	Yes	Yes	Yes	Yes	Yes	Yes
Heater protection	Yes	Yes	Yes	Yes	Yes	Yes
Circulation Pump	Asynchronous	Asynchronous	Asynchronous	Asynchronous	Asynchronous	BLDC
Auto Door Technology	No	No	No	No	No	Yes
Programs						
Prewash	Yes	Yes	Yes	No	No	No
Mini 18'	No	No	No	Yes	Yes	Yes
Eco 50°C	Yes	Yes	Yes	Yes	Yes	Yes
Intensive 65°C	Yes	No	No	Yes	No	No
Intensive 70°C	No	Yes	No	No	No	No
Quick 30' 40°C	No	Yes	Yes	Yes	Yes	Yes
Super 50' 65°C	Yes	Yes	No	Yes	Yes	Yes
Super 55' 60°C	No	No	Yes	No	No	No
Delicate 40°C	No	No	No	No	No	No
Normal 55°C	No	No	No	No	No	No
Dual Pro Wash 60°C	No	No	No	No	No	Yes
Auto Delicate 30°C - 50°C	No	No	Yes	No	Yes	Yes
Auto Normal 50°C - 60°C	No	No	Yes	No	Yes	No
Auto Intensive 60°C - 70°C	No	No	Yes	No	Yes	Yes (50°C-70°C)
Hygiene 60°C	No	No	Yes	Yes	Yes	Yes
Hygiene 70°C	No	No	No	No	No	No
Extra Intensive 70°C (Prewash Button + Intensive 65°C)	No	No	No	No	No	No
Extra Hygiene 70°C (Prewash Button + Hygiene 60°C)	No	No	Yes	No	No	No
User Interface						
Program selection button	Yes	Yes	Yes	Yes	Yes	Yes
Prewash button	No	No	Yes	No	No	No
DISPLAY (delay start (1-2-3-...-19hr), remaining time)	No	No	Yes	Yes	Yes	Yes
Delay timer button	No	Yes (3hr,6hr,9hr)	Yes	Yes	Yes	Yes
Half load button (1 mode)	No	No	No	Yes	No	No
Half load button (with 3 modes)	No	No	Yes	No	Yes	Yes
Tablet button	No	No	Yes	Yes	Yes	Yes
Energy Save button	No	No	No	No	No	Yes
Extra Rinse option	No	No	No	No	Yes	No
Extra Silent option	No	No	No	No	No	Yes
Extra Fast option	No	No	No	No	No	Yes
Rinse-aid indicator	Yes	Yes	Yes	Yes	Yes	Yes
Salt indicator	Yes	Yes	Yes	Yes	Yes	Yes
End of Cycle indicator	Yes	Yes	Yes	No	No	No
Buzzer	Yes	Yes	Yes	Yes	Yes	Yes
InfoLED	No	No	No	(o)	(o)	(o)
Baskets & Accessories						
3rd basket	No	No	No(12ps), Yes (15ps)	No	No(12ps), Yes (15ps)	Yes
Upper basket types [mesh type / peg type]	(o)	(o)	(o)	(o)	(o)	Peg
Adjustable upper basket when empty	(o)	(o)	(o)	(o)	(o)	Yes
Adjustable upper basket when loaded	(o)	(o)	(o)	(o)	(o)	(o)
Number of mug shelves	2 (std) / 4 (o)	2 (std) / 4 (o)	2 (std) / 4 (o)	2 (std) / 4 (o)	2 (std) / 4 (o)	4
Adjustable mug shelves (peg)	Yes	Yes	Yes	Yes	Yes	Yes
Adjustable mug shelves (mesh)	(o)	(o)	(o)	(o)	(o)	No
Foldable racks on upper basket (peg)	fixed (std) / 2 or 4 or 6 (o)	fixed (std) / 2 or 4 or 6 (o)	fixed (std) / 2 or 4 or 6 (o)	fixed (std) / 2 or 4 or 6 (o)	fixed (std) / 2 or 4 or 6 (o)	4 or 6 (o)
Foldable racks on lower basket	(o)	(o)	(o)	(o)	(o)	Yes
Wire basket handles	(o)	(o)	(o)	(o)	(o)	No
Plastic basket handles	(o)	(o)	(o)	(o)	(o)	Yes
Removable cutlery basket (Single piece)	(o)	(o)	(o)(12ps) / No(15ps)	(o)	(o)(12ps) / No(15ps)	No
Removable cutlery basket (Universal)	No	No	No(12ps) / (o)(15ps)	No	No(12ps) / (o)(15ps)	(o)
Removable cutlery basket (Modular) (2)	(o)	(o)	(o)	(o)	(o)	(o)
Removable cutlery basket (Sliding) (3)	(o)	(o)	(o)(12ps) / No(15ps)	(o)	(o)(12ps) / No(15ps)	No
Multi func. kit (Extra mug shelves + higher rear part on lower basket)	(o)	(o)	(o)	(o)	(o)	(o)
Bottle holder on lower basket	(o)	(o)	(o)	(o)	(o)	(o)
Wine stem support & Spoon rack on upper basket (2)	(o)	(o)	(o)	(o)	(o)	(o)
Top nozzle	No	No	(o)(12ps) / Yes(15ps)	No	(o)(12ps) / Yes(15ps)	Yes
Aquastop external hose	(o)	(o)	(o)	(o)	(o)	(o)
Interior light	No	(o)	(o)	(o)	(o)	(o)
Performance (4)						
Noise Level (dB(A))	57/54/52/49/47/45	57/54/52/49/47/45	54/52/49/47/45	57/54/52/49/47/45	54/52/49/47/45	44
Energy efficiency class	A++	A++	A++	A++	A++	A+++
Cleaning performance	A	A	A	A	A	A
Drying performance	A	A	A	A	A	A
Water consumption (lt)	12	12	9	12	9	9
Annual water consumption (lt/year)	3360	3360	2520	3360	2520	2520
Program duration (min)	187	187	162	187	171	195
Energy consumption (kWh)	0,90	0,90	0,90 / 0,94	0,90	0,90 / 0,94	0,79 / 0,84
Annual energy consumption (kWh/year)	258	258	258 / 267	258	258 / 267	225 / 239
Voltage (V) / Frequency (Hz)	220-240 / 50	220-240 / 50	220-240 / 50	220-240 / 50	220-240 / 50	220-240 / 50
Fuse Rating (A)	10	10	10	10	10	10
Dimensions						
Height (cm)	82,0	82,0	82,0	82,0	82,0	82,0
Width (cm)	59,8	59,8	59,8	59,8	59,8	59,8
Depth (cm)	55,0	55,0	55,0	55,0	55,0	55,0
Height adjustment (+cm)	5	5	5	5	5	5
Packed dimensions (Height x Width x Depth) (cm)	85,1 x 64,4 x 66,1	85,1 x 64,4 x 66,1	85,1 x 64,4 x 66,1	85,1 x 64,4 x 66,1	85,1 x 64,4 x 66,1	85,1 x 64,4 x 66,1
Stacking quantity (pcs)	5	5	5	5	5	5
Gross/Net weight (kg/5)	40/38	40/38	40/38	40/38	40/38	40/38
Container loading (40"/H/C/ 40"/ 20")	162/108/54	162/108/54	162/108/54	162/108/54	162/108/54	162/108/54

Notes

- (o) : Optional
- (1) : Turbo fan drying system & 3rd basket are default for 15ps models
- (2) : Modular cutlery basket for 12 PS must be selected with wine stem support & spoon rack. Also wine stem support & spoon rack can be selected only for mesh type upper basket option.
- (3) : Can be selected for lower basket with fixed type or with 4 foldable wire.
- (4) : Based on the tests performed with Eco 50°C program in accordance with EN 50242.
- (5) : Gros/Net Weights are shown as reference in the table. It should be calculated based on the final product features created from this general spect table.

DISHWASHERS//SPECIFICATIONS

SEMI-INTEGRATED SLIM X&T SERIES 45cm Models	X13	X1C	X15	X1E	T14	T15	T21	T22	T24
General Characteristics									
Number of Place Settings	10	10	10	10	10	10	10	10	10
Number of programs	4	4	6	6	7	7	8	8	8
Temperatures (°C)	50-65	50-65	40-50-65-70	40-50-65-70	40-50-65-70	40-50-65-70	Auto-30-40-50-60-65-70	Auto-30-40-50-60-65-70	Auto-30-40-50-60-65-70
Control type	full-electronic	full-electronic	full-electronic	full-electronic	full-electronic	full-electronic	full-electronic	full-electronic	full-electronic
Hidden heating element	Yes	Yes	Yes	Yes	Yes	Yes	Yes	Yes	Yes
Filter type	Metal	Metal	Metal	Metal	Metal	Metal	Metal	Metal	Metal
Turbidity sensor	No	No	No	No	No	No	Yes	Yes	Yes
Drying system	Natural/ Super Active	Natural/ Super Active	Natural/ Super Active	Natural/ Super Active	Natural/ Super Active	Natural/ Super Active	Natural/ Super Active	Turbo	Turbo
Overflow & leakage protection	Yes	Yes	Yes	Yes	Yes	Yes	Yes	Yes	Yes
Heater protection	Yes	Yes	Yes	Yes	Yes	Yes	Yes	Yes	Yes
Circulation Pump	Asynchronous	Asynchronous	Asynchronous	Asynchronous	Asynchronous	Asynchronous	Asynchronous	Asynchronous	BLDC
Programs									
Prewash	Yes	Yes	Yes	Yes	Yes	Yes	Yes	Yes	Yes
Eco 50°C	Yes	Yes	Yes	Yes	Yes	Yes	Yes	Yes	Yes
Intensive 65°C	Yes	Yes	Yes	Yes	Yes	Yes	No	No	No
Quick 30' 40°C	No	No	Yes	Yes	Yes	Yes	Yes	Yes	Yes
Super 50' 65°C	Yes	Yes	Yes	Yes	Yes	Yes	Yes	Yes	Yes
Delicate 40°C	No	No	No	No	Yes	Yes	No	No	No
Normal 55°C	No	No	No	No	No	No	No	No	No
Dual Pro Wash 60°C	No	No	No	No	No	No	No	No	Yes
Auto Delicate 30°C - 50°C	No	No	No	No	No	No	Yes	Yes	Yes
Auto Normal 50°C - 60°C	No	No	No	No	No	No	Yes	Yes	No
Auto Intensive 60°C - 70°C	No	No	No	No	No	No	Yes	Yes	Yes (50°C - 70°C)
Hygiene 60°C	No	No	No	No	No	No	No	No	No
Hygiene 70°C	No	No	Yes	Yes	Yes	Yes	Yes	Yes	Yes
Extra Intensive 70°C (Prewash Button + Intensive 65°C)*	No	No	No	No	No	No	No	No	No
User Interface									
Start/Pause	Yes	Yes	Yes	Yes	Yes	Yes	Yes	Yes	Yes
Program selection button	No	No	No	No	Yes	Yes	Yes	Yes	Yes
DISPLAY (delay start (1-2-3-...-24hr), remaining time)	No	Yes (up to 19hr)	No	Yes (up to 19hr)	Yes	No	Yes	Yes	Yes
Option button1 (Delay timer)	Yes (3hr,6hr,9hr)	No	Yes (3hr,6hr,9hr)	No	No	Yes (3hr,6hr,9hr)	No	No	No
Option button1 (Half load with 1 mode)	Yes	Yes	Yes	Yes	Yes	No	No	No	No
Half load button (with 3 modes)	No	No	No	No	No	No	Yes	Yes	Yes
Extra Rinse button	No	No	No	No	Yes	No	Yes	Yes	No
Extra Drying button	No	No	No	No	No	No	Yes	Yes	No
Tablet button	No	No	No	No	Yes	No	Yes	Yes	No
Energy Save option	No	No	No	No	No	No	No	No	Yes
Extra Silent option	No	No	No	No	No	No	No	No	Yes
Extra Fast option	No	No	No	No	No	No	No	No	Yes
Rinse-aid indicator	Yes	Yes	Yes	Yes	Yes	Yes	Yes	Yes	Yes
Salt indicator	Yes	Yes	Yes	Yes	Yes	Yes	Yes	Yes	Yes
Washing cycle indicators	Yes	Yes	Yes	Yes	Yes	Yes	Yes	Yes	Yes
Child Lock	No	Yes	No	Yes	Yes	Yes	Yes	Yes	Yes
Baskets & Accessories									
3rd Basket	No	No	No	No	No	No	No	(o)	Yes
Adjustable upper basket when empty	Yes	Yes	Yes	Yes	Yes	Yes	Yes	Yes	Yes
Adjustable upper basket when loaded	(o)	(o)	(o)	(o)	(o)	(o)	(o)	(o)	(o)
Number of mug shelves	4 (std)	4 (std)	4 (std)	4 (std)	4 (std)	4 (std)	4 (std)	4 (std)	4 (std)
Plastic basket handles	(o)	(o)	(o)	(o)	(o)	(o)	(o)	(o)	Yes
Foldable racks on lower basket	(o)	(o)	(o)	(o)	(o)	(o)	(o)	(o)	(o)
Foldable racks on upper basket	(o)	(o)	(o)	(o)	(o)	(o)	(o)	(o)	(o)
Removable cutlery basket (Universal)	Yes	Yes	Yes	Yes	Yes	Yes	Yes	(o)	(o)
Top nozzle	Yes	Yes	Yes	Yes	Yes	Yes	Yes	Yes	Yes
Aquastop external hose	(o)	(o)	(o)	(o)	(o)	(o)	(o)	(o)	(o)
Interior light	No	No	No	No	No	No	(o)	(o)	(o)
Performance (1)									
Noise Level (dB(A))	57/54/52/49/47/45	57/54/52/49/47/45	57/54/52/49/47/45	57/54/52/49/47/45	57/54/52/49/47/45	57/54/52/49/47/45	54/52/49/47/45	52/49/47/45	44
Energy efficiency class	A++(3)	A++(3)	A++(3)	A++(3)	A++(3)	A++(3)	A++(3)	A++	A+++
Cleaning performance	A	A	A	A	A	A	A	A	A
Drying performance	A	A	A	A	A	A	A	A	A
Water consumption (lt)	11(4)	11(4)	11(4)	11(4)	11(4)	11(4)	9	9	9
Annual water consumption (lt/year)	3080	3080	3080	3080	3080	3080	2520	2520	2520
Program duration (min)	172	172	172	172	172	172	164	198	185
Energy consumption (kWh)	0,73	0,73	0,73	0,73	0,73	0,73	0,73	0,73	0,65
Annual energy consumption (kWh/year)	211	211	211	211	211	211	211	211	188
Voltage (V) / Frequency (Hz)	220-240 / 50	220-240 / 50	220-240 / 50	220-240 / 50	220-240 / 50	220-240 / 50	220-240 / 50	220-240 / 50	220-240 / 50
Fuse Rating (A)	10	10	10	10	10	10	10	10	10
Dimensions									
Height (cm)	82,0	82,0	82,0	82,0	82,0	82,0	82,0	82,0	82,0
Width (cm)	45,0	45,0	45,0	45,0	45,0	45,0	45,0	45,0	45,0
Depth (cm)	57,0	57,0	57,0	57,0	57,0	57,0	57,0	57,0	57,0
Height adjustment (+cm)	5	5	5	5	5	5	5	5	5
Packed dimensions (Height x Width x Depth) (cm)	86,1 x 49,4 x 66,1	86,1 x 49,4 x 66,1	86,1 x 49,4 x 66,1	86,1 x 49,4 x 66,1	86,1 x 49,4 x 66,1	86,1 x 49,4 x 66,1	86,1 x 49,4 x 66,1	86,1 x 49,4 x 66,1	86,1 x 49,4 x 66,1
Stacking quantity (pcs)	5	5	5	5	5	5	5	5	5
Gross/Net weight (kg)(2)	34 /32	34 /32	34 /32	34 /32	34 /32	34 /32	34 /32	34 /32	34 /32
Container loading (40°C/ 40°/ 20°)	216 /144 /72	216 /144 /72	216 /144 /72	216 /144 /72	216 /144 /72	216 /144 /72	216 /144 /72	216 /144 /72	216 /144 /72

Notes
 (o) : Optional
 (1) : Based on the tests performed with Eco 50°C program in accordance with EN 50242.
 (2) : Gros/Net Weights are shown as reference in the table. It should be calculated based on the final product features created from this general spect table.
 (3) : A+ until April 2017
 (4) : 13 lt until April 2017

DISHWASHERS // SPECIFICATIONS

FULLY-INTEGRATED SLIM D SERIES 45cm Models	D12	D22	D32	D42	D41	D51	D52	D53
General Characteristics								
Number of Place Settings	10	10	10	10	10	12	12/15	15
Number of programs	3	6	8	8	8	6	8+	8+
Temperatures (°C)	50-65	40-50-65-70	40-50-60-65-70	Auto-30-40-50-60-65-70	Auto-30-40-50-60-65-70	40-50-65	Auto-30-40-50-60-70	Auto-30-40-50-60-70
Control type	full-electronic	full-electronic	full-electronic	full-electronic	full-electronic	Touch control	Touch control	Touch control
Hidden heating element	Yes	Yes	Yes	Yes	Yes	Yes	Yes	Yes
Filter type	Metal	Metal	Metal	Metal	Metal	Metal	Metal	Metal
Turbidity sensor	No	No	No	Yes	Yes	No	Yes	Yes
Drying system	Natural/ Super Active	Natural/ Super Active	Natural/ Super Active	Natural/ Super Active	Turbo	Natural/ Super Active	Turbo	Turbo
Overflow & leakage protection	Yes	Yes	Yes	Yes	Yes	Yes	Yes	Yes
Heater protection	Yes	Yes	Yes	Yes	Yes	Yes	Yes	Yes
Circulation Pump	Asynchronous	Asynchronous	Asynchronous	Asynchronous	Asynchronous	Asynchronous	Asynchronous	BLDC
Auto Door Technology	No	No	No	No	No	No	No	Yes
Programs								
Prewash	Yes	Yes	Yes	Yes	Yes	No	No	No
Mini 18'	No	No	No	No	No	Yes	Yes	Yes
Eco 50°C	Yes	Yes	Yes	Yes	Yes	Yes	Yes	Yes
Intensive 65°C	Yes	Yes	Yes	No	No	Yes	No	No
Quick 30' 40°C	No	Yes	Yes	Yes	Yes	Yes	Yes	Yes
Super 50' 65°C	No	Yes	Yes	Yes	Yes	Yes	Yes	Yes
Delicate 40°C	No	No	Yes	No	No	No	No	No
Normal 55°C	No	No	No	No	No	No	No	Yes
Daily 60°C	No	No	Yes	No	No	No	No	No
Auto Delicate 30°C - 50°C	No	No	No	Yes	Yes	No	Yes	Yes
Auto Normal 50°C - 60°C	No	No	No	Yes	Yes	No	Yes	No
Auto Intensive 60°C - 70°C	No	No	No	Yes	Yes	No	Yes	Yes (50°C-70°C)
Hygiene 60°C	No	No	No	No	No	Yes	Yes	Yes
Hygiene 70°C	No	Yes	Yes	Yes	Yes	No	No	No
User Interface								
Program selection button	Yes	Yes	Yes	Yes	Yes	Yes	Yes	Yes
DISPLAY (delay start (1-2-3...-19hr), remaining time)	No	No	Yes	Yes	Yes	Yes	Yes	Yes
Delay timer button	No	Yes (3hr,6hr,9hr)	Yes	Yes	Yes	Yes	Yes	Yes
Half load button (1 mode)	No	Yes	Yes	No	No	Yes	No	No
Half load button (with 3 modes)	No	No	No	Yes	Yes	No	Yes	Yes
Tablet button	No	No	Yes	Yes	Yes	Yes	Yes	Yes
Extra Rinse button	No	No	No	No	No	No	Yes	No
Extra Silent option	No	No	No	No	No	No	No	Yes
Extra Fast option	No	No	No	No	No	No	No	Yes
Rinse-aid indicator	Yes	Yes	Yes	Yes	Yes	Yes	Yes	Yes
Salt indicator	Yes	Yes	Yes	Yes	Yes	Yes	Yes	Yes
End of cycle indicator	Yes	Yes	Yes	Yes	Yes	No	No	No
Buzzer	Yes	Yes	Yes	Yes	Yes	Yes	Yes	Yes
InfoLED	No	No	No	No	No	(o)	(o)	(o)
Baskets & Accessories								
3rd Basket	No	No	No	No	Yes	No	(o)	Yes
Adjustable upper basket when empty	Yes	Yes	Yes	Yes	Yes	Yes	Yes	Yes
Adjustable upper basket when loaded	(o)	(o)	(o)	(o)	(o)	(o)	(o)	(o)
Number of mug shelves	4 (std)	4 (std)	4 (std)	4 (std)	4 (std)	4 (std)	4 (std)	4 (std)
Plastic basket handles	(o)	(o)	(o)	(o)	(o)	(o)	(o)	(o)
Foldable racks on lower basket	(o)	(o)	(o)	(o)	(o)	(o)	(o)	(o)
Foldable racks on upper basket	(o)	(o)	(o)	(o)	(o)	(o)	(o)	(o)
Removable cutlery basket (Universal)	Yes	Yes	Yes	Yes	(o)	Yes	(o)	(o)
Top nozzle	Yes	Yes	Yes	Yes	Yes	Yes	Yes	Yes
Aquastop external hose	(o)	(o)	(o)	(o)	(o)	(o)	(o)	(o)
Interior light	No	No	No	(o)	(o)	(o)	(o)	(o)
Performance (1)								
Noise Level (dB(A))	57/54/52/49/47/45	57/54/52/49/47/45	57/54/52/49/47/45	54/52/49/47/45	52/49/47/45	57/54/52/49/47/45	54/52/49/47/45	44
Energy efficiency class	A++(3)	A++(3)	A++(3)	A++(3)	A++	A+	A++	A+++
Cleaning performance	A	A	A	A	A	A	A	A
Drying performance	A	A	A	A	A	A	A	A
Water consumption (lt)	11(4)	11(4)	11(4)	12	9	12	9	9
Annual water consumption (lt/year)	3080	3080	3080	3360	2520	3360	2520	2520
Program duration (min)	186	186	186	167	191	186	191	185
Energy consumption (kWh)	0,73	0,73	0,73	0,73	0,73	0,83	0,73	0,65
Annual energy consumption (kWh/year)	211	211	211	211	211	237	211	188
Voltage (V) / Frequency (Hz)	220-240 / 50	220-240 / 50	220-240 / 50	220-240 / 50	220-240 / 50	220-240 / 50	220-240 / 50	220-240 / 50
Fuse Rating (A)	10	10	10	10	10	10	10	10
Dimensions								
Height (cm)	82,0	82,0	82,0	82,0	82,0	82,0	82,0	82,0
Width (cm)	45,0	45,0	45,0	45,0	45,0	45,0	45,0	45,0
Depth (cm)	55,0	55,0	55,0	55,0	55,0	55,0	55,0	55,0
Height adjustment (+cm)	5	5	5	5	5	5	5	5
Packed dimensions (Height x Width x Depth) (cm)	86,1 x 49,4 x 66,1	86,1 x 49,4 x 66,1	86,1 x 49,4 x 66,1	86,1 x 49,4 x 66,1	86,1 x 49,4 x 66,1	86,1 x 49,4 x 66,1	86,1 x 49,4 x 66,1	86,1 x 49,4 x 66,1
Stacking quantity (pcs)	5	5	5	5	5	5	5	5
Gross/Net weight (kg/2)	34 /32	34 /32	34 /32	34 /32	34 /32	34 /32	34 /32	34 /32
Container loading (40'H/C/ 40' / 20')	216 /144 /72	216 /144 /72	216 /144 /72	216 /144 /72	216 /144 /72	216 /144 /72	216 /144 /72	216 /144 /72

Notes

- (o) : Optional
- (1) : Based on the tests performed with Eco 50°C program in accordance with EN 50242.
- (2) : Gross/Net Weights are shown as reference in the table. It should be calculated based on the final product features created from this general spect table.
- (3) : A+ until April 2017
- (4) : 13 lt until April 2017

OVENS&HOBS // SPECIFICATIONS

60cm BUILT-IN OVEN SPECIFICATION SHEET		60cm ELECTRIC BUILT-IN OVEN	60cm PYROLYTIC BUILT-IN OVEN	60cm ELECTRIC POLYVALENTE BUILT-IN OVEN
Dimensions				
Product Height	mm	595	595	595
Product Width	mm	595	595	595
Product Depth (with / without Control Panel)	mm	575 / 550	575 / 550	575 / 550
Cabinet Dimensions (Width / Height / Depth) -If control panel located inside the cabinet	mm	600 / 600 / 590	600 / 600 / 590	600 / 600 / 590
Cabinet Dimensions (Width / Height / Depth) -If control panel not located inside the cabinet	mm	560 / 590 / 555	560 / 590 / 555	560 / 590 / 555
Oven Features				
Oven Type		Electric	Electric (Pyrolytic)	Electric
Oven Volume (without/with fan)	lt	61 / 56 - 72 / 65	56 (old platform) 65 (new platform)	61 / 56 - 72 / 65
Cavity Dimensions (without/with fan)	mm	430 x 429 x 335 / 430 x 391 x 335 - 450 x 451 x 352 / 450 x 413x 352	430 x 391 x 335 (old platform) 450 x 404 x 352 (new platform)	430 x 429 x 335 / 430 x 391 x 335 - 450 x 451 x 352 / 450 x 413x 352
Oven Light (25W)		Optional	Standard	Optional
Easy to Clean Enamel		Standard	-	Standard
Catalytic Enamel Panels (Left, right and rear)		Optional	-	Optional
Pyrolytic Enamel		-	Standard	-
Wire Side Racks		Optional	Optional	Optional
Telescopic Rails (1 or 2 racks)		Optional	Optional	Optional
Top Heating Element	W	1200	1200	1200
Bottom Heating Element	W	1100	1100	1100
Thermostat		Standard	Electronic	Standard
Grill (Thermostatic)	W	1400	1400	1400
Double Grill (Thermostatic)	W	2600	2600	2600
Fan	W	23	23	23
Fan with Ring Heating Element	W	2000	2000	2000
Automatic Boost Function		available for some control unit	available for some control unit	available for some control unit
Turnspit		Optional	Optional	Optional
Oven Functions		Up to 9	Up to 7	Up to 9
Thermostat Operation Indicator Light		Standard	Standard	Standard
Oven Operation Indicator Light		Standard	-	-
Hotplate Operation Indicator Light (in case of polyvalente oven)		-	-	Standard
Oven Door lock indicator light		-	Standard	-
Minute Minder		Optional	-	Optional
Mechanical Timer		Optional	-	Optional
Analog Timer		Optional	-	Optional
Digital Clock		Optional	-	Optional
Digital Programmer		Optional	Standard	Optional
Digital Programmer with touch interface		Optional	-	Optional
Full Touch LED Display		Optional	Optional	Optional
Knob Control LED Display and Touch Interface (Visio Touch)		Optional	Optional	-
Knob Control LED Display (Visio Display)		Optional	-	-
Smart LCD (Ready Cook)		Optional	-	-
Monochrome LCD		Optional	-	-
Baking Tray (Shallow Tray)		Optional	1	Optional
Roasting Tray (Deep Tray)		1	Optional	1
Glass Tray		Optional	Optional	Optional
Chromed Grid with Stoper		1	1	1
Wire grid for deep tray		Optional	Optional	Optional
Broil Pan with Handle Set		Optional	Optional	Optional
Self Cleaning Period	hours	-	1,5 / 1	-
Energy Consumption during Self Cleaning Function	kwh	-	2,6	-
Available Colours				
White		Standard	Standard	Standard
Black		Optional	Optional	Optional
Stainless Steel		Optional	Optional	Optional
Terre De France		Optional	Optional	Optional
Mink		Optional	Optional	Optional
Claret Red		Optional	Optional	Optional
Cream		Optional	Optional	Optional
Rustik (Black / White / Cream)		Optional	Optional	Optional
Silver		Optional	Optional	Optional
Control Panel				
Metal		Standard	Standard	Standard
Glass		Optional	Optional	Optional
Various Types of Inox Add-on on Glass Control Panel		Optional	Optional	Optional
Oven Door				
Full outer glass and small inner glass with metal frame (4 glasses)		-	Standard	-
Full inner glass and full glass front face (4 glasses) Oven Door		-	Optional	-
Full outer glass and inner metal door (small glass) Oven Door		Standard	-	Standard
Full outer glass and inner glass Oven Door		Optional	-	Optional
Full outer glass and full inner glass Oven Door		Optional	-	Optional
Cool touch Oven door		Optional	-	Optional
Mirror Oven Door Glass		Optional	-	Optional
Removable Oven Door		Standard	Standard	Standard
Various Types of Inox Add-on on Oven Door Glass		Optional	Optional	Optional
Child Lock on Oven Door		Optional	Standard (Electromechanic)	Optional
Others				
Total Power (Depends on Model) Maximum	kW	3,1	2,6	3,1
Tangential Cooling Fan (in case of built-in oven with cooling fan)	W	11,5	23 / 40 (double level)	11,5
Tangential Cooling Fan Noise Level	dBA	49	53 (for pyrolytic function) 49 (for cooking function)	49
Voltage	V	230	230	230
Electric Cooker Energy Rating (Depends on Model)		A++/A+ / A / B	A / B	A / B
Cavity Insulation		White / Yellow	White (with Aluminum foil)	White / Yellow
Pop-in / Pop-out Knob		Optional	Optional	Optional
Hob controls on Control Panel (in case of polyvalente oven)		Standard	-	Standard
Main Cable		Standard	Standard	Standard
Shrink Packed Product Dimensions (Width / Depth / Height)	mm	680 x 630 x 640	680 x 630 x 640	680 x 630 x 640
Carton Box Packaging		Optional	Optional	Optional
RoHS Compliance		Standard	Standard	Standard
CE Compliance		Standard	Standard	Standard
Net Weight (Depends on Model) Maximum	kg	35	34	35
Gross Weight (Depends on Model) Maximum	kg	37,7	36,2	37,7
Container Loading Quantity (20 ft Container)	pcs	81	81	81
Container Loading Quantity (40 ft Container)	pcs	162	162	162
Container Loading Quantity (40 ft HC Container)	pcs	216	216	216

OVENS&HOBS//SPECIFICATIONS

60cm BUILT-IN OVEN SPECIFICATION SHEET		60cm ELECTRIC BUILT-IN OVEN (75L)	60cm ELECTRIC POLYVALENTE BUILT-IN OVEN (75L)
Dimensions			
Product Height	mm	595	595
Product Width	mm	595	595
Product Depth (with / without Control Panel)	mm	575 / 550	575 / 550
Cabinet Dimensions (Width / Height / Depth) -If control panel located inside the cabinet	mm	600 / 600 / 590	600 / 600 / 580
Cabinet Dimensions (Width / Height / Depth) -If control panel not located inside the cabinet	mm	560 / 590 / 555	560 / 580 / 555
Oven Features			
Oven Type		Electric	Electric
Oven Volume (without/with fan)	lt	80 / 73(mold runners) - 85 / 78(wire rack)	80 / 73(mold runners) - 85 / 78(wire rack)
Cavity Dimensions (without/with fan)	mm	450 x 451 x 392 / 450 x 413x 392	450 x 451 x 392 / 450 x 413x 392
Oven Light (25W)		Standard	Standard
Easy to Clean Enamel		Standard	Standard
Catalytic Enamel Panels (Left, right and rear)		Optional	Optional
Wire Side Racks		Optional	Optional
Telescopic Rails (1 or 2 racks)		Optional	Optional
Top Heating Element	W	1200	1200
Bottom Heating Element	W	1100	1100
Thermostat		Standard	Standard
Grill (Thermostatic)	W	1400	1400
Double Grill (Thermostatic)	W	2600	2600
Fan	W	23	23
Fan with Ring Heating Element	W	2000	2000
Automatic Boost Function		available for some control unit	available for some control unit
Turnspit		Optional	Optional
Oven Functions		Up to 9	Up to 9
Thermostat Operation Indicator Light		Standard	Standard
Oven Operation Indicator Light		Standard	-
Hotplate Operation Indicator Light (in case of polyvalente oven)		-	Standard
Minute Minder		Optional	Optional
Mechanical Timer		Optional	Optional
Digital Clock		Optional	Optional
Digital Programmer		Optional	Optional
Digital Programmer with touch interface		Optional	Optional
Knob Control LED Display and Touch Interface (Visio Touch)		Optional	-
Knob Control LED Display (Visio Display)		Optional	-
Smart LCD (Ready Cook)		Optional	-
Monochrome LCD		Optional	-
Baking Tray (Shallow Tray)		Optional	Optional
Roasting Tray (Deep Tray)		1	1
Glass Tray		Optional	Optional
Chromed Grid with Stoper		1	1
Wire grid for deep tray		Optional	Optional
Broil Pan with Handle Set		Optional	Optional
Available Colours			
White		Standard	Standard
Black		Optional	Optional
Stainless Steel		Optional	Optional
Terre De France		Optional	Optional
Mink		Optional	Optional
Claret Red		Optional	Optional
Cream		Optional	Optional
Rustik (Black / White / Cream)		Optional	Optional
Silver		Optional	Optional
Control Panel			
Metal		Standard	Standard
Glass		Optional	Optional
Various Types of Inox Add-on on Glass Control Panel		Optional	Optional
Oven Door			
Full outer glass and full inner glass Oven Door		Standard	Standard
Mirror Oven Door Glass		Optional	Optional
Removable Oven Door		Standard	Standard
Various Types of Inox Add-on on Oven Door Glass		Optional	Optional
Others			
Total Power (Depends on Model) Maximum	kW		
Tangential Cooling Fan (in case of built-in oven with cooling fan)	W	11,5	11,5
Tangential Cooling Fan Noise Level	dBA	49	49
Voltage	V	230	230
Electric Cooker Energy Rating (Depends on Model)		A-B	A-B
Cavity Insulation		White / Yellow	White / Yellow
Pop-in / Pop-out Knob		Optional	Optional
Hob controls on Control Panel (in case of combi oven)		Standard	Standard
Main Cable		Standard	Standard
Shrink Packed Product Dimensions (Width / Depth / Height)	mm	680 x 630 x 640	680 x 630 x 640
Carton Box Packaging		Optional	Optional
RoHS Compliance		Standard	Standard
CE Compliance		Standard	Standard
Net Weight (Depends on Model) Maximum	kg	36	36
Gross Weight (Depends on Model) Maximum	kg	38,2	38,2
Container Loading Quantity (20 ft Container)	pcs	81	81
Container Loading Quantity (40 ft Container)	pcs	162	162
Container Loading Quantity (40 ft HC Container)	pcs	216	216

BUILT-IN / TABLE-TOP HOB SPECIFICATION SHEET		BI Gas/Combined Hobs							
		60 CM	60 CM	60 CM	60 CM	60 CM	60 CM	70 CM	70 CM
		Flat / Surface	Extenda	Classic	Model I	PlusX	Division	Model I	PlusX
Available Colours									
White		Standard	Standard	Standard	Standard	Standard	-	Standard	Standard
Brown		Optional	Optional	Optional	Optional	Optional	-	Optional	Optional
Terre de France		Optional	Optional	Optional	Optional	Optional	-	Optional	Optional
Black		Optional	Optional	Optional	Optional	Optional	-	Optional	Optional
Dark Green		Optional	Optional	Optional	Optional	Optional	-	Optional	Optional
Stainless Steel		Optional	Optional	Optional	Optional	Optional	Standard	Optional	Optional
Product Dimensions									
Height (max., varies from model to model)	mm	40	40	40	39,5	42	42	39,5	42
Width	mm	580	580	580	590	580	580	680	700
Depth (max., do not include gas connection detail)	mm	510	510	510	515	515	510	515	515
Cut-out Dimensions									
Width	mm	560	560	560	560	560	560	560	560
Depth	mm	490	490	490	490	490	490	490	490
Hob Features									
Hob		Enamel / Stainless Steel	Enamel / Stainless Steel	Enamel / Stainless Steel	Enamel / Stainless Steel	Enamel / Stainless Steel	Stainless Steel	Enamel / Stainless Steel	Enamel / Stainless Steel
Rapid Gas Burner Ø10cm	W	3000	3000	3000	3000	3000	3000	3000	3000
Semi-rapid Gas Burner Ø7.5cm	W	1750	1750	1750	1750	1750	1750	1750	1750
Auxiliary Gas Burner Ø5.5cm	W	1000	1000	1000	1000	1000	1000	1000	1000
Wok (Triple Flame) Gas Burner Mono Ø14cm	W	3800	3800	3600	3600	-	-	3600	3600
Wok (Triple Flame) Gas Burner Dual Ø14cm	W	-	-	-	-	-	-	-	-
Wok (Triple Flame) Gas Burner Ø11cm	W	-	-	-	-	3200	-	-	-
Ø 145 mm Hotplate	W	-	-	1000	1000	1000	-	1000	1000
Ø 180 mm Hotplate	W	1500	1500	-	-	-	-	-	-
Ø 145 mm Rapid Hotplate	W	-	-	-	-	-	-	-	-
Ø 180 mm Rapid Hotplate	W	-	-	-	-	-	-	-	-
Ø145 mm Highlite Element	W	-	-	-	-	-	-	-	-
Ø180 mm Highlite Element	W	-	-	-	-	-	-	-	-
Ø210 mm Highlite Element	W	-	-	-	-	-	-	-	-
Ø180 mm Dual Highlite Element	W	-	-	-	-	-	-	-	-
Ø145 mm Oval Highlite Element	W	-	-	-	-	-	-	-	-
Ø210 mm Dual Highlite Element	W	-	-	-	-	-	-	-	-
Ø210 mm Triple Highlite Element	W	-	-	-	-	-	-	-	-
Ø290 mm Dual/Triple Highlite Element	W	-	-	-	-	-	-	-	-
Ø 160 mm Induction Zone(Serie 1 and Serie 2)	W	-	-	-	-	-	-	-	-
Ø 200 mm Induction Zone(Serie 1)	W	-	-	-	-	-	-	-	-
Ø 210 mm Induction Zone(Serie 2)	W	-	-	-	-	-	-	-	-
Ø 250 mm Induction Zone(Serie 1)	W	-	-	-	-	-	-	-	-
Ø 290 mm Induction Zone(Serie 2)	W	-	-	-	-	-	-	-	-
Boost Function		-	-	-	-	-	-	-	-
Pot Dedection		-	-	-	-	-	-	-	-
Automatic Heatup		-	-	-	-	-	-	-	-
Timer function for vitro ceramic hobs (If touch control with some hob configuration selected)		-	-	-	-	-	-	-	-
Mode function for induction ceramic hobs (If touch control with some hob configuration selected)		-	-	-	-	-	-	-	-
Bridge zone for induction ceramic hobs (If touch control with some hob configuration selected)		-	-	-	-	-	-	-	-
Child Lock for vitro ceramic hobs (If touch control selected)		-	-	-	-	-	-	-	-
Mechanical Child Lock (Main Switch)		-	-	-	-	-	-	-	-
Hot Surface Indicator Light		-	-	-	-	-	-	-	-
Hotplate Operation Indicator Light		Standard	Standard	Standard	Standard	Standard	-	Standard	Standard
Side Knob Control		Standard	Standard	Standard	-	-	-	-	-
Side Touch Control		-	-	-	-	-	-	-	-
Front Knob Control		-	-	-	Standard	Standard	-	Standard	Standard
Double Side Front Control		-	-	-	-	-	Standard	-	-
Front Triangular Touch Control		-	-	-	-	-	-	-	-
Front Slider Touch Control		-	-	-	-	-	-	-	-
Front Touch Control		-	-	-	-	-	-	-	-
Bevelled Edges		-	-	-	-	-	-	-	-
Logo		Standard	Standard	Standard	Standard	Standard	Standard	Standard	Standard
Special Decoration on Glass		-	-	-	-	-	-	-	-
Vitroceramic Glass Artwork		-	-	-	-	-	-	-	-
Inox Frame		-	-	-	-	-	-	-	-
Stainless Steel Burner Pan		-	-	-	-	-	-	-	-
Table Top Installation (not built-in)		Optional	Optional	Optional	-	-	-	-	-
Glass Lid		-	-	-	-	-	-	-	-
Burner Safety Valves		Standard	Standard	Standard	Standard	Standard	Standard	Standard	Standard
Button Ignition		Optional	Optional	Optional	Optional	Optional	-	Optional	Optional
One-touch-Ignition through knobs		Optional	Optional	Optional	Optional	Optional	Standard	Optional	Optional
Enamel Pan Supports		Standard	Standard	Standard	Standard	Standard	-	Standard	Standard
Cast Iron Pan Supports		Optional	Optional	-	Optional	Optional	Standard	Optional	Optional
Cast Iron Burner Caps		Optional	Optional	-	Optional	Optional	Optional	Optional	Optional
Coffee Adaptor		Optional	Optional	Optional	Optional	Optional	Optional	Optional	Optional
Wok Adaptor		Optional	Optional	Optional	Optional	Optional	-	Optional	Optional
Vitroceramic Glass Cleaning Spatula		-	-	-	-	-	-	-	-
Gas Conversion Kit		Standard	Standard	Standard	Standard	Standard	Standard	Standard	Standard
Others									
Total Gas Power (Depends on Model) Maximum	kW	8,3	8,3	8,1	8,1	7,7	7,5	11,1	11,1
Total Electric Power (Depends on Model) Maximum	kW	1,5	1,5	1	1	1	-	1	1
Voltage	V	230V~	230V~	230V~	230V~	230V~	230V~	230V~	230V~
RoHS Compliance		Standard	Standard	Standard	Standard	Standard	Standard	Standard	Standard
CE Compliance		Standard	Standard	Standard	Standard	Standard	Standard	Standard	Standard
Carton Box Packaging		Standard	Standard	Standard	Standard	Standard	Standard	Standard	Standard
Packed Product Dimensions (WxDxH)	mm	626 x 580 x 140	x	626 x 560 x 130	641 x 576 x 161	x	x	731 x 576 x 161	x
Loading Quantity 20 ft (Wrapped Carton)	pcs	576	x	612	448	x	x	420	x
Loading Quantity 40 ft (Wrapped Carton)	pcs	1216	x	1292	1008	x	x	896	x
Loading Quantity 40 HC (Wrapped Carton)	pcs	1368	x	1444	1152	x	x	1024	x
Packed Product Dimensions (WxDxH) Box	mm	640 x 584 x 152	647 x 582 x 164	635 x 564 x 142	x	647 x 582 x 164	647 x 582 x 164	x	769 x 582 x 164
Loading Quantity 20 ft (Carton Box)	pcs	405	378	576	x	378	378	x	378
Loading Quantity 40 ft (Carton Box)	pcs	900	840	1152	x	840	840	x	840
Loading Quantity 40 HC (Carton Box)	pcs	1020	960	1296	x	960	960	x	960
Net Weight (Depends on Model) Maximum	kg	9	9,5	6,6	9,8	9,5	11	10,7	12,5
Gross Weight (Depends on Model) Maximum	kg	9,75	10,5	7,5	10,6	10,5	12	11,6	13,5

OVENS&HOBS//SPECIFICATIONS

BUILT-IN / TABLE-TOP HOB SPECIFICATION SHEET		BI Gas Securit Hobs							
		60 CM	60 CM	60 CM	60 CM	60 CM	70 CM	70 CM	90 CM
		Securit II	Trio	Model I	PlusX	Division	Model I	PlusX	
Available Colours									
White		Optional	Optional	Optional	Optional	-	Optional	Optional	Optional
Brown		Optional	Optional	Optional	Optional	-	Optional	Optional	Optional
Terre de France		Optional	Optional	Optional	Optional	-	Optional	Optional	Optional
Black		Standard	Standard	Standard	Standard	Standard	Standard	Standard	Standard
Dark Green		Optional	Optional	Optional	Optional	-	Optional	Optional	Optional
Stainless Steel		-	-	-	-	-	-	-	-
Product Dimensions									
Height (max., varies from model to model)	mm	44	44	39,5	44	44	39,5	44	47
Width	mm	594	594	590	594	594	680	700	882
Depth (max., do not include gas connection detail)	mm	523	523	515	523	523	515	520	520
Cut-out Dimensions									
Width	mm	560	560	560	560	560	560	560	850
Depth	mm	490	490	490	490	490	490	490	480
Hob Features									
Hob		Securit	Securit	Securit	Securit	Securit	Securit	Securit	Securit
Rapid Gas Burner Ø10cm	W	3000	3000	3000	3000	3000	3000	3000	3000
Semi-rapid Gas Burner Ø7.5cm	W	1750	1750	1750	1750	1750	1750	1750	1750
Auxiliary Gas Burner Ø5.5cm	W	1000	1000	1000	1000	1000	1000	1000	1000
Wok (Triple Flame) Gas Burner Mono Ø14cm	W	3800	3600	3800	3600	-	3800	3600	4500
Wok (Triple Flame) Gas Burner Dual Ø14cm	W	-	-	-	-	-	-	-	4500
Wok (Triple Flame) Gas Burner Ø11cm	W	-	-	-	-	-	-	-	-
Ø 145 mm Hotplate	W	-	-	-	1000	-	-	-	-
Ø 180 mm Hotplate	W	-	-	-	-	-	-	-	-
Ø 145 mm Rapid Hotplate	W	-	-	-	-	-	-	-	-
Ø 180 mm Rapid Hotplate	W	-	-	-	-	-	-	-	-
Ø145 mm Highlite Element	W	-	-	-	-	-	-	-	-
Ø180 mm Highlite Element	W	-	-	-	-	-	-	-	-
Ø210 mm Highlite Element	W	-	-	-	-	-	-	-	-
Ø180 mm Dual Highlite Element	W	-	-	-	-	-	-	-	-
Ø145 mm Oval Highlite Element	W	-	-	-	-	-	-	-	-
Ø210 mm Dual Highlite Element	W	-	-	-	-	-	-	-	-
Ø210 mm Triple Highlite Element	W	-	-	-	-	-	-	-	-
Ø290 mm Dual/Triple Highlite Element	W	-	-	-	-	-	-	-	-
Ø 160 mm Induction Zone(Serie 1 and Serie 2)	W	-	-	-	-	-	-	-	-
Ø 200 mm Induction Zone(Serie 1)	W	-	-	-	-	-	-	-	-
Ø 210 mm Induction Zone(Serie 2)	W	-	-	-	-	-	-	-	-
Ø 250 mm Induction Zone(Serie 1)	W	-	-	-	-	-	-	-	-
Ø 290 mm Induction Zone(Serie 2)	W	-	-	-	-	-	-	-	-
Boost Function		-	-	-	-	-	-	-	-
Pot Dedection		-	-	-	-	-	-	-	-
Automatic Heatup		-	-	-	-	-	-	-	-
Timer function for vitro ceramic hobs (If touch control with some hob configuration selected)		-	-	-	-	-	-	-	-
Mode function for induction ceramic hobs (If touch control with some hob configuration selected)		-	-	-	-	-	-	-	-
Bridge zone for induction ceramic hobs (If touch control with some hob configuration selected)		-	-	-	-	-	-	-	-
Child Lock for vitro ceramic hobs (If touch control selected)		-	-	-	-	-	-	-	-
Mechanical Child Lock (Main Switch)		-	-	-	-	-	-	-	Optional
Hot Surface Indicator Light		-	-	-	-	-	-	-	-
Hotplate Operation Indicator Light		-	-	Standard	Standard	-	-	-	-
Side Knob Control		Standard	Standard	-	-	-	-	-	-
Side Touch Control		-	-	-	-	-	-	-	-
Front Knob Control		-	-	Standard	Standard	-	Standard	Standard	Standard
Double Side Front Control		-	-	-	-	Standard	-	-	-
Front Triangular Touch Control		-	-	-	-	-	-	-	-
Front Slider Touch Control		-	-	-	-	-	-	-	-
Front Touch Control		-	-	-	-	-	-	-	-
Bevelled Edges		-	-	-	-	-	-	-	Optional
Logo		Optional	Optional	Standard	Standard	Standard	Standard	Standard	Standard
Special Decoration on Glass		Optional	Optional	-	-	-	-	-	-
Vitrocemamic Glass Artwork		-	-	-	-	-	-	-	-
Inox Frame		-	-	Standard	-	-	Standard	-	Optional
Stainless Steel Burner Pan		Optional	Optional	Optional	Optional	-	Optional	Optional	Optional
Table Top Installation (not built-in)		-	-	-	-	-	-	-	-
Glass Lid		-	-	-	-	-	-	-	-
Burner Safety Valves		Standard	Standard	Standard	Standard	Standard	Standard	Standard	Standard
Button Ignition		Optional	Optional	Optional	-	-	Optional	-	-
One-touch-Ignition through knobs		Optional	Optional	Optional	Optional	Standard	Optional	Optional	Standard
Enamel Pan Supports		Standard	Standard	Standard	Standard	Standard	Standard	Standard	-
Cast Iron Pan Supports		Optional	Optional	Optional	Optional	Standard	Optional	Optional	Standard
Cast Iron Burner Caps		Optional	Optional	Optional	Optional	Optional	Optional	Optional	Standard
Coffee Adaptor		Optional	Optional	Optional	Optional	Optional	Optional	Optional	Optional
Wok Adaptor		Optional	Optional	Optional	Optional	-	Optional	Optional	Optional
Vitrocemamic Glass Cleaning Spatula		-	-	-	-	-	-	-	-
Gas Conversion Kit		Standard	Standard	Standard	Standard	Standard	Standard	Standard	Optional
Others									
Total Gas Power (Depends on Model) Maximum	kW	8,3	8,1	8,3	8,1	7,5	11,3	11,1	12
Total Electric Power (Depends on Model) Maximum	kW	-	-	-	1	-	-	-	-
Voltage	V	230V-	230V-	230V-	230V-	230V-	230V-	230V-	230V-
RoHS Compliance		Standard	Standard	Standard	Standard	Standard	Standard	Standard	Standard
CE Compliance		Standard	Standard	Standard	Standard	Standard	Standard	Standard	Standard
Carton Box Packaging		Standard	Standard	Standard	Standard	Standard	Standard	Standard	Standard
Packed Product Dimensions (WxDxH)	mm	622 x 580 x 140	622 x 580 x 140	641 x 576 x 161	x	x	731 x 576 x 161	x	x
Loading Quantity 20 ft (Wrapped Carton)		576 (without wok burner)	432 (with wok burner)	576	448	x	x	420	x
Loading Quantity 40 ft (Wrapped Carton)		1216 (without wok burner)	912 (with wok burner)	1216	1008	x	x	896	x
Loading Quantity 40 HC (Wrapped Carton)		1368 (without wok burner)	912 (with wok burner)	1368	1152	x	x	1024	x
Packed Product Dimensions (WxDxH) Box	mm	x	x	x	647 x 582 x 164	647 x 582 x 164	x	769 x 582 x 164	935 x 582 x 164
Loading Quantity 20 ft (Carton Box)	pcs	x	x	x	378	378	x	378	252
Loading Quantity 40 ft (Carton Box)	pcs	x	x	x	840	840	x	840	560
Loading Quantity 40 HC (Carton Box)	pcs	x	x	x	960	960	x	960	640
Net Weight (Depends on Model) Maximum	kg	9,5	9,5	10,7	11,5	-	13,7	13,8	20,5
Gross Weight (Depends on Model) Maximum	kg	10,25	10,25	11,13	12,5	-	14,2	14,8	21,5

BUILT-IN / TABLE-TOP HOB SPECIFICATION SHEET	BI Electric Hobs		BI Vitro Ceramic Hobs		BI Induction Ceramic Hobs		
	60 CM	60 CM	78 CM	60 CM	78 CM	90CM	
	Flat / Surface	C Serie	C Serie	Vestel Induction	Vestel Induction	Vestel Induction	
Available Colours							
White	Standard	Optional	Optional	Optional	Optional	Optional	
Brown	Optional	-	-	-	-	-	
Terre de France	Optional	-	-	-	-	-	
Black	Optional	Standard	Standard	Standard	Standard	Standard	
Dark Green	Optional	-	-	-	-	-	
Stainless Steel	Optional	-	-	-	-	-	
Product Dimensions							
Height (max., varies from model to model)	mm	40	41- 47,5	41	56	56	56
Width	mm	580	590	780	590	590	890
Depth (max., do not include gas connection detail)	mm	510	520	520	520	520	520
Cut-out Dimensions							
Width	mm	560	560	750	560	750	860
Depth	mm	490	490	490	490	490	490
Hob Features							
Hob		Enamel / Stainless Steel	Vitro Ceramic	Vitro Ceramic	Induction Ceramic	Induction Ceramic	Induction Ceramic
Rapid Gas Burner Ø10cm	W	Enamel / Stainless Steel	Vitro Ceramic	Vitro Ceramic	Induction Ceramic	Induction Ceramic	Induction Ceramic
Semi-rapid Gas Burner Ø7,5cm	W	-	-	-	-	-	-
Auxiliary Gas Burner Ø5,5cm	W	-	-	-	-	-	-
Wok (Triple Flame) Gas Burner Mono Ø14cm	W	-	-	-	-	-	-
Wok (Triple Flame) Gas Burner Dual Ø14cm	W	-	-	-	-	-	-
Wok (Triple Flame) Gas Burner Ø11cm	W	-	-	-	-	-	-
Ø 145 mm Hotplate	W	-	-	-	-	-	-
Ø 180 mm Hotplate	W	1000	-	-	-	-	-
Ø 145 mm Rapid Hotplate	W	1500	-	-	-	-	-
Ø 180 mm Rapid Hotplate	W	1500	-	-	-	-	-
Ø145 mm Highlite Element	W	2000	-	-	-	-	-
Ø180 mm Highlite Element	W	-	1200	1200	-	-	-
Ø210 mm Highlite Element	W	-	1800	1800	-	-	-
Ø180 mm Dual Highlite Element	W	-	2300	2300	-	-	-
Ø145 mm Oval Highlite Element	W	-	1700	1700	-	-	-
Ø210 mm Dual Highlite Element	W	-	1800	1800	-	-	-
Ø210 mm Triple Highlite Element	W	-	2200	2200	-	-	-
Ø290 mm Dual/Triple Highlite Element	W	-	2300	2300	-	-	-
Ø 160 mm Induction Zone(Serie 1 and Serie 2)	W	-	2700	-	-	-	-
Ø 200 mm Induction Zone(Serie 1)	W	-	-	-	Nominal 2100 W max. Boost 2500 W	Nominal 2100 W max. Boost 2500 W	Nominal 2100 W max. Boost 2500 W
Ø 210 mm Induction Zone(Serie 2)	W	-	-	-	Nominal 2100 W max. Boost 2500 W	-	-
Ø 250 mm Induction Zone(Serie 1)	W	-	-	-	Nominal 2800 W max. Boost 3500 W	Nominal 2800 W max. Boost 3500 W	Nominal 2800 W max. Boost 3500 W
Ø 290 mm Induction Zone(Serie 2)	W	-	-	-	Nominal 2800 W max. Boost 3500 W	-	-
Boost Function		-	-	-	Standard	Standard	Standard
Pot Dedection		-	-	-	Standard	Standard	Standard
Automatic Heatup		-	-	-	-	-	-
Timer function for vitro ceramic hobs (If touch control with some hob configuration selected)		-	Optional	Optional	Optional	Optional	Standard
Mode function for induction ceramic hobs (If touch control with some hob configuration selected)		-	-	-	Optional	Optional	-
Bridge zone for induction ceramic hobs (If touch control with some hob configuration selected)		-	-	-	Optional	-	-
Child Lock for vitro ceramic hobs (If touch control selected)		-	Standard	Standard	Standard	Standard	Standard
Mechanical Child Lock (Main Switch)		-	-	-	-	-	-
Hot Surface Indicator Light		-	Standard	Standard	Standard	Standard	Standard
Hotplate Operation Indicator Light		Standard	-	-	-	-	-
Side Knob Control		Standard	Standard	-	-	-	-
Side Touch Control		-	Optional	-	-	-	-
Front Knob Control		-	-	-	-	-	-
Double Side Front Control		-	-	-	-	-	-
Front Triangular Touch Control		-	Optional	Standard	-	-	-
Front Slider Touch Control		-	Optional	Optional	Optional	Optional	-
Front Touch Control		-	-	-	Optional	Optional	Optional
Bevelled Edges		-	Optional	Optional	Optional	Optional	Optional
Logo		Standard	Optional	Optional	Optional	Optional	Optional
Special Decoration on Glass		-	Optional	Optional	Optional	Optional	Optional
Vitroceraamic Glass Artwork		-	Slim / Arc / Point	Slim / Arc / Point	Slim / Plus / Line	Slim / Plus / Line	Slim / Plus / Line
Inox Frame		-	Optional	-	Optional	Optional	Optional
Stainless Steel Burner Pan		-	-	-	-	-	-
Table Top Installation (not built-in)		-	-	-	-	-	-
Glass Lid		-	-	-	-	-	-
Burner Safety Valves		-	-	-	-	-	-
Button Ignition		-	-	-	-	-	-
One-touch-Ignition through knobs		-	-	-	-	-	-
Enamel Pan Supports		-	-	-	-	-	-
Cast Iron Pan Supports		-	-	-	-	-	-
Cast Iron Burner Caps		-	-	-	-	-	-
Coffee Adaptor		-	-	-	-	-	-
Wok Adaptor		-	-	-	-	-	-
Vitroceraamic Glass Cleaning Spatula		-	Optional	Optional	Optional	Optional	Optional
Gas Conversion Kit		-	-	-	-	-	-
Others							
Total Gas Power (Depends on Model) Maximum	kW	-	-	-	-	-	-
Total Electric Power (Depends on Model) Maximum	kW	6	6,5	8,3	7,4	7,4	10,8
Voltage	V	230V- / 400V 2N-	230V- / 400V 3N-	230V- / 400V 3N-	230V- / 400V 3N-	230V- / 400V 3N-	230V- / 400V 3N-
RoHS Compliance		Standard	Standard	Standard	Standard	Standard	Standard
CE Compliance		Standard	Standard	Standard	Standard	Standard	Standard
Carton Box Packaging		Standard	Standard	Standard	Standard	Standard	Standard
Packed Product Dimensions (WxDxH)	mm	626 x 580 x 140	620 x 578 x 133	810 x 578 x 133	626 x 581 x 142	816 x 581 x 142	926 x 581 x 142
Loading Quantity 20 ft (Wrapped Carton)	pcs	576	612	476	432	336	252
Loading Quantity 40 ft (Wrapped Carton)	pcs	1216	1292	952	960	672	560
Loading Quantity 40 HC (Wrapped Carton)	pcs	1368	1444	1064	1080	756	560
Packed Product Dimensions (WxDxH) Box	mm	640 x 584 x 152	631 x 580 x 143	x	643 x 583 x 152	x	941 x 583 x 152
Loading Quantity 20 ft (Carton Box)	pcs	405	576	x	405	x	252
Loading Quantity 40 ft (Carton Box)	pcs	900	1152	x	900	x	560
Loading Quantity 40 HC (Carton Box)	pcs	1020	1296	x	1020	x	560
Net Weight (Depends on Model) Maximum	kg	9,5	9,5	10,15	11	12	16
Gross Weight (Depends on Model) Maximum	kg	10,25	10,25	11	12	13	17

OVENS&HOBS//SPECIFICATIONS

BUILT-IN / TABLE-TOP HOB SPECIFICATION SHEET	TT Gas/ Comnined/ Gas Securit Hobs				TT Electric Hobs			
	60 CM	60 CM	60 CM	60 CM	60 CM	60 CM	60 CM	
	Flat / Surface	Smoothline	New Gen.	PlusX	Flat / Surface	Smoothline	New Gen.	
Available Colours								
White	Standard	Standard	Standard	Optional	Standard	Standard	Standard	
Brown	Optional	Optional	-	Optional	Optional	Optional	-	
Terre de France	Optional	Optional	-	Optional	Optional	Optional	-	
Black	Optional	Optional	Optional	Standard	Optional	Optional	Optional	
Dark Green	Optional	Optional	-	Optional	Optional	Optional	-	
Stainless Steel	Optional	Optional	Optional	Optional	Optional	Optional	Optional	
Product Dimensions								
Height (max., varies from model to model)	mm	95,5 - 104,5	95,5 - 104,5	95,5 - 104,5	104	56,5 - 104,5	56,5 - 104,5	56,5 - 104,5
Width	mm	585	585	580	597	585	585	585
Depth (max., do not include gas connection detail)	mm	540	540	540	526	540	540	540
Cut-out Dimensions								
Width	mm	-	-	-	-	-	-	-
Depth	mm	-	-	-	-	-	-	-
Hob Features								
Hob		Enamel / Stainless Steel	Enamel / Stainless Steel	Enamel / Stainless Steel	Securit	Enamel / Stainless Steel	Enamel / Stainless Steel	Enamel / Stainless Steel
Rapid Gas Burner Ø10cm	W	3000	3000	3000	3000	-	-	-
Semi-rapid Gas Burner Ø7.5cm	W	1750	1750	1750	1750	-	-	-
Auxiliary Gas Burner Ø5.5cm	W	1000	1000	1000	1000	-	-	-
Wok (Triple Flame) Gas Burner Mono Ø14cm	W	3800	3600	3600	3600	-	-	-
Wok (Triple Flame) Gas Burner Dual Ø14cm	W	-	-	-	-	-	-	-
Wok (Triple Flame) Gas Burner Ø11cm	W	-	-	-	-	-	-	-
Ø 145 mm Hotplate	W	-	1000	-	1000	1000	1000	1000
Ø 180 mm Hotplate	W	1500	-	1500	-	1500	1500	1500
Ø 145 mm Rapid Hotplate	W	-	1500	-	-	1500	1500	1500
Ø 180 mm Rapid Hotplate	W	2000	-	2000	-	2000	2000	2000
Ø145 mm Highlite Element	W	-	-	-	-	-	-	-
Ø180 mm Highlite Element	W	-	-	-	-	-	-	-
Ø210 mm Highlite Element	W	-	-	-	-	-	-	-
Ø180 mm Dual Highlite Element	W	-	-	-	-	-	-	-
Ø145 mm Oval Highlite Element	W	-	-	-	-	-	-	-
Ø210 mm Dual Highlite Element	W	-	-	-	-	-	-	-
Ø210 mm Triple Highlite Element	W	-	-	-	-	-	-	-
Ø290 mm Dual/Triple Highlite Element	W	-	-	-	-	-	-	-
Ø 160 mm Induction Zone(Serie 1 and Serie 2)	W	-	-	-	-	-	-	-
Ø 200 mm Induction Zone(Serie 1)	W	-	-	-	-	-	-	-
Ø 210 mm Induction Zone(Serie 2)	W	-	-	-	-	-	-	-
Ø 250 mm Induction Zone(Serie 1)	W	-	-	-	-	-	-	-
Ø 290 mm Induction Zone(Serie 2)	W	-	-	-	-	-	-	-
Boost Funcion	-	-	-	-	-	-	-	-
Pot Dedection	-	-	-	-	-	-	-	-
Automatic Heatup	-	-	-	-	-	-	-	-
Timer function for vitro ceramic hobs (If touch control with some hob configuration selected)	-	-	-	-	-	-	-	-
Mode function for induction ceramic hobs (If touch control with some hob configuration selected)	-	-	-	-	-	-	-	-
Bridge zone for induction ceramic hobs (If touch control with some hob configuration selected)	-	-	-	-	-	-	-	-
Child Lock for vitro ceramic hobs (If touch control selected)	-	-	-	-	-	-	-	-
Mechanical Child Lock (Main Switch)	-	-	-	-	-	-	-	-
Hot Surface Indicator Light	-	-	-	-	-	-	-	-
Hotplate Operation Indicator Light	Standard	Standard	Standard	Standard	Standard	Standard	Standard	
Side Knob Control	Standard	Standard	Standard	-	Standard	Standard	Standard	
Side Touch Control	-	-	-	-	-	-	-	
Front Knob Control	-	-	-	Standard	-	-	-	
Double Side Front Control	-	-	-	-	-	-	-	
Front Triangular Touch Control	-	-	-	-	-	-	-	
Front Slider Touch Control	-	-	-	-	-	-	-	
Front Touch Control	-	-	-	-	-	-	-	
Bevelled Edges	-	-	-	-	-	-	-	
Logo	Standard	Standard	Standard	Standard	Standard	Standard	Standard	
Special Decoration on Glass	-	-	-	-	-	-	-	
Vitroceraamic Glass Artwork	-	-	-	-	-	-	-	
Inox Frame	-	-	-	-	-	-	-	
Stainless Steel Burner Pan	-	-	-	-	-	-	-	
Table Top Installation (not built-in)	Standard	Standard	Standard	Standard	Standard	Standard	Standard	
Glass Lid	Optional	Optional	Optional	-	Optional	Optional	Optional	
Burner Safety Valves	Standard	Standard	Standard	Standard	-	-	-	
Button Ignition	Optional	Optional	Optional	Optional	-	-	-	
One-touch-Ignition through knobs	Optional	Optional	Optional	Optional	-	-	-	
Enamel Pan Supports	Standard	Standard	Standard	Standard	-	-	-	
Cast Iron Pan Supports	Optional	Optional	Optional	Optional	-	-	-	
Cast Iron Burner Caps	Optional	Optional	Optional	Optional	-	-	-	
Coffee Adaptor	Optional	Optional	Optional	Optional	-	-	-	
Wok Adaptor	Optional	Optional	Optional	Optional	-	-	-	
Vitroceraamic Glass Cleaning Spatula	-	-	-	-	-	-	-	
Gas Conversion Kit	Standard	Standard	Standard	Standard	-	-	-	
Others								
Total Gas Power (Depends on Model) Maximum	kW	8,3	8,1	8,1	8,1	-	-	-
Total Electric Power (Depends on Model) Maximum	kW	-	-	-	1	6	6	6
Voltage	V	230V~	230V~	230V~	230V~	230 / 400V 3N~	230 / 400V 3N~	230 / 400V 3N~
RoHS Compliance		Standard	Standard	Standard	Standard	Standard	Standard	Standard
CE Compliance		Standard	Standard	Standard	Standard	Standard	Standard	Standard
Carton Box Packaging		Standard	Standard	Standard	Standard	Standard	Standard	Standard
Packed Product Dimensions (WxDxH)	mm	643 x 645 x 132	643 x 645 x 132	x	x	643 x 645 x 132	643 x 645 x 132	x
Loading Quantity 20 ft (Wrapped Carton)	pcs	408	408	x	x	408	408	x
Loading Quantity 40 ft (Wrapped Carton)	pcs	918	918	x	x	918	918	x
Loading Quantity 40 HC (Wrapped Carton)	pcs	1026	1026	x	x	1026	1026	x
Packed Product Dimensions (WxDxH) Box	mm	662 x 648 x 140 (default for glass lid option)	662 x 648 x 140 (default for glass lid option)	662 x 648 x 140	645 x 648 x 140	662 x 648 x 140 (default for glass lid option)	662 x 648 x 140 (default for glass lid option)	662 x 648 x 140
Loading Quantity 20 ft (Carton Box)	pcs	348	348	348	384	384	384	384
Loading Quantity 40 ft (Carton Box)	pcs	864	864	864	864	864	864	864
Loading Quantity 40 HC (Carton Box)	pcs	972	972	972	972	972	972	972
Net Weight (Depends on Model) Maximum	kg	13	13	14	15	13,5	13,5	14,5
Gross Weight (Depends on Model) Maximum	kg	14.25	14.25	15	16	14.75	14.75	15,5

DOMINO HOB SPECIFICATION SHEET	Domino Gas Hobs		Domino Electirc Hobs		Domino Gas Securit Hobs		Domino Vitro Ceramic Hobs		Domino Induction Ceramic Hobs	
	30 CM		30 CM		30 CM		30 CM		30 CM	
Available Colours										
White		-	-	-	Optional	-	Optional	-	Optional	-
Brown		-	-	-	-	-	-	-	-	-
Terre de France		-	-	-	-	-	-	-	-	-
Black		-	-	-	Standard	-	Standard	-	Standard	-
Dark Green		-	-	-	-	-	-	-	-	-
Stainless Steel		Standard	Standard	-	-	-	-	-	-	-
Product Dimensions										
Height (varies from model to model)	mm	42,5	42,5	47,5	47,5	47,5	47,5	56		
Width	mm	290	290	290	290	290	290	290		
Depth	mm	510	510	520	520	520	520	520		
Cut-out Dimensions										
Width	mm	270	270	270	270	270	270	270		
Depth	mm	490	490	490	490	490	490	490		
Hob Features										
Hob		Stainless Steel	Stainless Steel	Securit	Vitro Ceramic	Induction Ceramic				
Rapid Gas Burner Ø10cm	W	3000	-	3000	-	-	-	-	-	-
Semi-rapid Gas Burner Ø7.5cm	W	-	-	-	-	-	-	-	-	-
Auxillary Gas Burner Ø5.5cm	W	1000	-	1000	-	-	-	-	-	-
Wok (Triple Flame) Gas Burner Ø14cm	W	3600	-	3600	-	-	-	-	-	-
Ø 145 mm Hotplate	W	-	1000	-	-	-	-	-	-	-
Ø 180 mm Hotplate	W	-	1500	-	-	-	-	-	-	-
Ø 145 mm Rapid Hotplate	W	-	-	-	-	-	-	-	-	-
Ø 180 mm Rapid Hotplate	W	-	2000	-	-	-	-	-	-	-
Ø145 mm Highlite Element	W	-	-	-	1200	-	-	-	-	-
Ø180 mm Highlite Element	W	-	-	-	1800	-	-	-	-	-
Ø210 mm Highlite Element	W	-	-	-	-	-	-	-	-	-
Ø180 mm Dual Element	W	-	-	-	1700	-	-	-	-	-
Ø145 mm Oval Element	W	-	-	-	-	-	-	-	-	-
Ø210 mm Dual Element	W	-	-	-	-	-	-	-	-	-
Ø210 mm Triple Element	W	-	-	-	-	-	-	-	-	-
Ø270 mm Triple Element	W	-	-	-	-	-	-	-	-	-
Rectangular Element	W	-	-	-	-	-	-	-	-	-
Ø 160 mm Induction Zone	W	-	-	-	-	-	-	Nominal 1400W max. Boost 1800W	-	-
Ø 200 mm Induction Zone	W	-	-	-	-	-	-	Nominal 2100W max. Boost 2500W	-	-
Oval Induction Zone										
Boost Funcion										Standard
Pot Dedection										Standard
Automatic Heatup										Standard
Timer function for vitro ceramic hobs (if touch control with some hob configuration selected)										Standard
Child Lock for vitro ceramic hobs (if touch control selected)							Standard			Standard
Hot Surface Indicator Light							Standard			Standard
Hotplate Operation Indicator Light			Standard							
Side Knob Control			Standard							
Side Touch Control										
Front Knob Control		Standard			Standard		Standard			
Front Touch Control							Optional			Standard
Front Slim Touch Control										
Bevelled Edges							Optional			Optional
Logo		Standard	Standard		Optional		Optional			Optional
Special Decoration on Glass					Optional		Optional			Optional
Inox Frame					Optional		Optional			Optional
Stainless Steel Burner Pan					Optional					
Table Top Installation (not built-in)										
Glass Lid										
Burner Safety Valves		Optional			Optional					
Button Ignition		Optional								
One-touch-Ignition through knobs		Optional			Optional					
Enamel Pan Supports		Standard			Standard					
Cast Iron Pan Supports		Optional			Optional					
Cast Iron Burner Caps		Optional			Optional					
Coffee Adaptor		Optional			Optional					
Wok Adaptor		Optional			Optional					
Vitroceramic Glass Cleaning Spatula							Optional			Optional
Gas Conversion Kit		Standard			Standard					
Gas Conversion Kit		Standard			Standard					
Others										
Total Power (Depends on Model) Maximum	kW	4	3,5	4	3	3,6				
Voltage	V	230 V ~	230 V ~	230V ~	230 V~	230 V~				
RoHS Compliance		Standard	Standard	Standard	Standard	Standard				
CE Compliance		Standard	Standard	Standard	Standard	Standard				
Carton Box Packaging		Standard	Standard	Standard	Standard	Standard				
Packed Product Dimensions (WxDxH)	mm	x	x	330 x 578 x 140	326 x 578 x 133	332 x 581 x 142				
Packed Product Dimensions (WxDxH) Box	mm	331 x 566 x 143	331 x 566 x 143	x	x	x				
Net Weight (Depends on Model) Maximum	kg	5,5	4,75	4,7	4,7	5,5				
Gross Weight (Depends on Model) Maximum	kg	6	5,4	5	5	6,2				
Container Loading Quantity (20 ft Container)	pcs	1190	1190	1088	1088	864				
Container Loading Quantity (40 ft Container)	pcs	2499	2499	2304	2304	1920				
Container Loading Quantity (40 ft HC Container)	pcs	2793	2793	2592	2592	2160				

OVENS&HOBS//SPECIFICATIONS

































POLY HOB SPECIFICATION SHEET		Electric Built-in Hob	Vitroceramic Built-in Hob	Induction Built-in Hob
		60cm	60cm	60cm
Available Colours				
White		Standard	Optional	-
Brown		Optional	-	-
Terre de France		Optional	-	-
Black		Optional	Standard	Standard
Dark Green		Optional	-	-
Stainless Steel		Optional	-	-
Product Dimensions				
Height	mm	39	41	53
Width	mm	580	590	590
Depth	mm	510	520	520
Cut-out Dimensions				
Width	mm	560	560	560
Depth	mm	490	490	490
Hob Features				
Hob		Enamel	Vitroceramic	Induction
Ø 145 mm Hotplate	W	1000	-	-
Ø 180 mm Hotplate	W	1500	-	-
Ø145 mm Highlite Element	W	-	1200	-
Ø180 mm Highlite Element	W	-	1800	-
Ø180 mm Dual Element	W	-	1700	-
Ø145 mm Oval Element	W	-	1800	-
Ø210 mm Highlite Element	W	-	2300	-
Ø145 mm Radiant Heating Element	W	-	1200	-
Ø180 mm Radiant Heating Element	W	-	1700	-
Ø 160 mm Induction Zone	W	-	-	Nominal 1400 W max. Boost 1800 W
Ø 200 mm Induction Zone	W	-	-	Nominal 2100 W max. Boost 2500 W
Boost Function		-	-	Standard
Pot Dedection		-	-	Standard
Timer (If touch control and some hob configuration selected for vitroceramic hob)		-	-	Standard
Child Lock (If touch control selected for vitroceramic hob)		-	-	Standard
Hot Surface Indicator Light		-	Standard	Standard
Controls on the built-in oven panel		Standard	Standard	Standard
Controller		7 step switch	Energy Regulator/ 7 step switch (with radiant element)	Encoder
Hotplate Operation Indicator Light		Standard	-	-
Bevelled Edges		-	Optional	Optional
Logo		Standard	Optional	Optional
Special Artwork on Glass		-	Optional	Optional
Standart Vitroceramic Glass Artwork		-	Slim Design Arc Design Point Design	Slim Design Arc Design Point Design
Inox Frame		-	Optional	Optional
Vitroceramic Glass Cleaning Spatula		-	Optional	Optional
Others				
Total Power (Depends on Model) Maximum	kW	8,1	9,6	10,5
Voltage	V	230V~	230V~	230V~
RoHS Compliance		Standard	Standard	Standard
CE Compliance		Standard	Standard	Standard
Carton Box Packaging		Standard	Standard	Standard
Packed Product Dimensions (WxDxH)	mm	628x580x137	618x578x132	624x580x142
Net Weight (Depends on Model) Maximum	kg	8,75	7	11
Gross Weight (Depends on Model) Maximum	kg	9,5	8	12

65 It Built-in Oven Energy Class Declerations			
Model Description	Oven Function Designation	Available Energy Class Declerations	Function used for Energy Decleration
Static	(01/02/03/04/13/14/15)	B (yellow insulation) A (white insulation)	Upper + Lower
Turbo Fan	(05/06/07/08/09/16/17/18/19/23/24/50/51/52/53)	B (yellow insulation) A (yellow/white insulation) A+ (white insulation & Smart LCD Control)	Fan + Ring
Fan assisted	(10/11/12/20/21/22/25/26)	B (yellow insulation) A (yellow/white insulation)	Upper + Lower + Fan

*: Owner of this document is Vestel Beyaz Esya A.S.(VBE). VBE has right to make changes on these values without notification by referring this document. - 14.05.2015

60 It Built-in Oven Energy Class Declerations			
Model Description	Oven Function Designation	Available Energy Class Declerations	Function used for Energy Decleration
Static	(01/02/03/04/13/14/15)	B (with / without cooling fan) A (with / without cooling fan)	Upper + Lower
Turbo Fan	(05/06/07/08/09/16/17/18/19/23/24/27/28/29/50/51/52/53)	B (with cooling fan) A (with cooling fan)	Fan + Ring
Fan assisted	(10/11/12/20/21/22/25/26)	B (with cooling fan) A (with cooling fan)	Upper + Lower + Fan

*: Owner of this document is Vestel Beyaz Esya A.S.(VBE). VBE has right to make changes on these values without notification by referring this document. - 14.05.2015

Electric Oven Function for Built-in Ovens							
Function ID	Identity in the Market		Heating Element, Fan, Turnspit, Grill Availability	Oven Functions	Electrical Power at 230V	Number of Functions	Limitations
01	Static oven		(Top + Bottom)	0 / TOP+BOTTOM / BOTTOM / TOP	2300	3	-
02	Static oven		(Top + Bottom) + Grill + Turnspit	0 / TOP+BOTTOM / BOTTOM / TOP / GRILL+TURNSPIT	2300	4	-
03	Static oven		(Top + Bottom) + Grill + Turnspit	0 / TOP+BOTTOM / BOTTOM / GRILL+TURNSPIT / DOUBLE GRILL+TURNSPIT	2600	4	Not available for built-in oven without cooling fan
04	Static oven		(Top + Bottom) + Grill + Turnspit	0 / OVENLIGHT / TOP+BOTTOM / BOTTOM / TOP / GRILL+TURNSPIT / DOUBLE GRILL+TURNSPIT	2600	6	Not available for built-in oven without cooling fan
06	FAN+RING oven		(Fan + Ring) + Grill + Turnspit	0 / DEFROST / FAN+RING / GRILL+TURNSPIT / GRILL+FAN+TURNSPIT	2000	4	Not available for built-in oven without cooling fan
07	Multifunction oven		(Top + Bottom + Fan + Ring) + Grill + Turnspit	0 / DEFROST / FAN+RING / TOP+BOTTOM / TOP+BOTTOM+FAN / GRILL+TURNSPIT / GRILL+FAN+TURNSPIT	2300	6	Not available for built-in oven without cooling fan
08	Multifunction oven		(Top + Bottom + Fan + Ring) + Grill + Turnspit	0 / DEFROST / FAN+RING / TOP+BOTTOM / TOP+BOTTOM+FAN / GRILL+TURNSPIT / DOUBLE GRILL+TURNSPIT	2600	6	Not available for built-in oven without cooling fan
09	Multifunction oven		(Top + Bottom + Fan + Ring) + Grill + Turnspit	0 / OVENLIGHT / DEFROST / FAN+RING / TOP+BOTTOM / TOP+BOTTOM+FAN / PIZZA / GRILL+TURNSPIT / DOUBLE GRILL+TURNSPIT / DOUBLE GRILL+FAN+TURNSPIT	3100	9	Not available for built-in oven without cooling fan
10	Fan assisted oven		(Top + Bottom + Fan) + Grill + Turnspit	0 / DEFROST / TOP+BOTTOM / TOP+BOTTOM+FAN / GRILL+TURNSPIT / GRILL+FAN+TURNSPIT	2300	5	Not available for built-in oven without cooling fan
11	Fan assisted oven		(Top + Bottom + Fan) + Grill + Turnspit	0 / DEFROST / TOP+BOTTOM / TOP+BOTTOM+FAN / GRILL+TURNSPIT / DOUBLE GRILL+TURNSPIT	2600	5	Not available for built-in oven without cooling fan
12	Fan assisted oven		(Top + Bottom + Fan) + Grill + Turnspit	0 / OVENLIGHT / DEFROST / TOP+BOTTOM / TOP+BOTTOM+FAN / BOTTOM+FAN / GRILL+TURNSPIT / DOUBLE GRILL+TURNSPIT / DOUBLE GRILL+FAN+TURNSPIT	2600	8	Not available for built-in oven without cooling fan
13	Static oven		(Top + Bottom) + Grill	0 / TOP+BOTTOM / BOTTOM / TOP / GRILL	2300	4	-
14	Static oven		(Top + Bottom) + Grill	0 / TOP+BOTTOM / BOTTOM / GRILL / DOUBLE GRILL	2600	4	Not available for built-in oven without cooling fan
15	Static oven		(Top + Bottom) + Grill	0 / OVENLIGHT / TOP+BOTTOM / BOTTOM / TOP / GRILL / DOUBLE GRILL	2600	6	Not available for built-in oven without cooling fan
16	FAN+RING oven		(Fan + Ring) + Grill	0 / DEFROST / FAN+RING / GRILL / GRILL+FAN	2000	4	Not available for built-in oven without cooling fan
17	Multifunction oven		(Top + Bottom + Fan + Ring) + Grill	0 / DEFROST / FAN+RING / TOP+BOTTOM / TOP+BOTTOM+FAN / GRILL / GRILL+FAN	2300	6	Not available for built-in oven without cooling fan
18	Multifunction oven		(Top + Bottom + Fan + Ring) + Grill	0 / DEFROST / FAN+RING / TOP+BOTTOM / TOP+BOTTOM+FAN / GRILL / DOUBLE GRILL	2600	6	Not available for built-in oven without cooling fan
19	Multifunction oven		(Top + Bottom + Fan + Ring) + Grill	0 / OVENLIGHT / DEFROST / FAN+RING / TOP+BOTTOM / TOP+BOTTOM+FAN / PIZZA / GRILL / DOUBLE GRILL / DOUBLE GRILL+FAN	3100	9	Not available for built-in oven without cooling fan
20	Fan assisted oven		(Top + Bottom + Fan) + Grill	0 / DEFROST / TOP+BOTTOM / TOP+BOTTOM+FAN / GRILL / GRILL+FAN	2300	5	Not available for built-in oven without cooling fan
21	Fan assisted oven		(Top + Bottom + Fan) + Grill	0 / DEFROST / TOP+BOTTOM / TOP+BOTTOM+FAN / GRILL / DOUBLE GRILL	2600	5	Not available for built-in oven without cooling fan
22	Fan assisted oven		(Top + Bottom + Fan) + Grill	0 / OVENLIGHT / DEFROST / TOP+BOTTOM / TOP+BOTTOM+FAN / BOTTOM+FAN / GRILL / DOUBLE GRILL / DOUBLE GRILL+FAN	2600	8	Not available for built-in oven without cooling fan
23	Multifunction oven		(Top + Bottom + Fan + Ring)	0 / DEFROST / FAN+RING / TOP+BOTTOM / TOP+BOTTOM+FAN	2300	4	Not available for built-in oven without cooling fan
24	Multifunction oven		(Top + Bottom + Fan + Ring) + Turnspit	0 / DEFROST / FAN+RING+TURNSPIT / TOP+BOTTOM+TURNSPIT / TOP+BOTTOM+FAN+TURNSPIT	2300	4	Not available for built-in oven without cooling fan
25	Fan assisted oven		(Top + Bottom + Fan)	0 / DEFROST / TOP+BOTTOM / TOP+BOTTOM+FAN	2300	3	Not available for built-in oven without cooling fan
26	Fan assisted oven		(Top + Bottom + Fan) + Turnspit	0 / DEFROST / TOP+BOTTOM+TURNSPIT / TOP+BOTTOM+FAN+TURNSPIT	2300	3	Not available for built-in oven without cooling fan
27	Fan assisted oven		(Top + Bottom + Fan) + Grill	0 / DEFROST / TOP+BOTTOM / TOP+BOTTOM+FAN / GRILL / DOUBLE GRILL / PYROLYSIS	2600	6	Available for only pyrolytic oven
28	Multifunction oven		(Top + Bottom + Fan + Ring) + Grill	0 / DEFROST / FAN+RING / TOP+BOTTOM / TOP+BOTTOM+FAN / GRILL / DOUBLE GRILL / DOUBLE GRILL + FAN / PYROLYSIS	2600	8	Available for only pyrolytic oven
29	Multifunction oven		(Top + Bottom + Fan + Ring) + Grill + Turnspit	0 / DEFROST / FAN+RING / TOP+BOTTOM / TOP+BOTTOM+FAN / GRILL+TURNSPIT / DOUBLE GRILL+TURNSPIT / DOUBLE GRILL+FAN+TURNSPIT / PYROLYSIS	2600	8	Available for only pyrolytic oven
50	Multifunction oven		(Top + Bottom + Fan + Ring) + Grill + Turnspit	0 / OVENLIGHT / DEFROST / FAN+RING / TOP+BOTTOM / TOP+BOTTOM+FAN / PIZZA / GRILL + TURNSPIT / DOUBLE GRILL+TURNSPIT / DOUBLE GRILL+FAN + TURNSPIT / VAP CLEAN	3100	10	Not available for built-in oven without cooling fan
51	Multifunction oven		(Top + Bottom + Fan + Ring) + Grill	0 / OVENLIGHT / DEFROST / FAN+RING / TOP+BOTTOM / TOP+BOTTOM+FAN / PIZZA / GRILL / DOUBLE GRILL / DOUBLE GRILL+FAN / VAP CLEAN	2300	10	Not available for built-in oven without cooling fan
52	Fan assisted oven		(Top + Bottom + Fan) + Grill	0 / DEFROST / BOTTOM / TOP+BOTTOM / TOP+BOTTOM+FAN / GRILL / GRILL+FAN	2300	6	Not available for built-in oven without cooling fan
53	Fan assisted oven		(Top + Bottom + Fan)	0 / BOTTOM / TOP / TOP+BOTTOM / TOP+BOTTOM+FAN	2300	4	Not available for built-in oven without cooling fan

OVENS&HOBS//SPECIFICATIONS

Induction Hob Configurations for Built-in Hobs and Polyvalente Hobs					
HOB ID	CONFIGURATION	LIMITATIONS	ELEMENT PLACEMENT	GENERATION	CONTROL SYSTEM
18	2 x 160mm,1400/1800W induction element 2 x 200mm, 2100/2500W induction element	Available for both 60cm and 78cm		VESTEL SERI 1	STANDARD
19	2 x 160mm,1400/1800W induction element 2 x 200mm, 2100/2500W induction element with timer	Available for both 60cm and 78cm		VESTEL SERI 1	STANDARD OR SLIDER CONTROL
20	2 x 160mm,1400/1800W induction element 2 x 200mm, 2100/2500W induction element with timer	Available only for POLYVALENTE		VESTEL SERI 1	KNOB CONTROL
20	1 x 160mm,1400/1800W induction element 2 x 200mm, 2100/2500W induction element	Available only for 60cm		VESTEL SERI 1	STANDARD
21	1 x 160mm,1400/1800W induction element 2 x 200mm, 2100/2500W induction element with timer	Available only for 60cm		VESTEL SERI 1	STANDARD OR SLIDER CONTROL
22	1 x 160mm, 1400/1800W induction element 1 x 200mm, 2100/2500W induction element 1 x 250mm, 2800/3500W induction element	Available only for 60cm		VESTEL SERI 1	STANDARD
23	1 x 160mm, 1400/1800W induction element 1 x 200mm, 2100/2500W induction element 1 x 250mm, 2800/3500W induction element with timer	Available only for 60cm		VESTEL SERI 1	STANDARD OR SLIDER CONTROL
24	2 x 160mm, 1400/1800W induction element 1 x 200mm, 2100/2500W induction element	Available only for 30cm		VESTEL SERI 1	STANDARD
25	3 x 160mm, 1400/1800W induction element 1 x 200mm, 2100/2500W induction element with timer	Available only for 30cm		VESTEL SERI 1	STANDARD
26	2 x 160mm, 1400/1800W induction element 2 x 200mm, 2100/2500W induction element 1 x 250mm, 2800/3500W induction element with timer	Available only for 90cm		VESTEL SERI 1	STANDARD
27	3 x 160mm, 1400/1800W induction element 1 x 200mm, 2100/2500W induction element bridge zone,mode function, timer	Available only for 60cm		VESTEL SERI 1	STANDARD
28	1 x 160mm, 1400/1800W induction element 2 x 210mm, 2100/2500W induction element	Available only for 60cm		VESTEL SERI 2	STANDARD
29	1 x 160mm, 1400/1800W induction element 2 x 210mm, 2100/2500W induction element with timer	Available only for 60cm		VESTEL SERI 2	STANDARD OR SLIDER CONTROL
30	1 x 160mm, 1400/1800W induction element 1 x 210mm, 2100/2500W induction element 1 x 290mm, 2800/3500W induction element	Available only for 60cm		VESTEL SERI 2	STANDARD
31	1 x 160mm, 1400/1800W induction element 1 x 210mm, 2100/2500W induction element 1 x 290mm, 2800/3500W induction element with timer	Available only for 60cm		VESTEL SERI 2	STANDARD OR SLIDER CONTROL
32	2 x 160mm, 1400/1800W induction element 2 x 210mm, 2100/2500W induction element	Available only for 60cm		VESTEL SERI 2	STANDARD
33	2 x 160mm, 1400/1800W induction element 2 x 210mm, 2100/2500W induction element with timer	Available only for 60cm		VESTEL SERI 2	STANDARD OR SLIDER CONTROL

78cm Vitroceramic Hob Configurations			
HOB ID	Highlight Element Configuration	ELEMENT PLACEMENT	CONTROL SYSTEM
1	2 x 145 Highlite, 1 x oval, 1 x 180 highlite element		STANDART
*2	2 x 145 Highlite, 1 x oval, 1 x 180 highlite element with timer		
3	2 x 145 Highlite, 1 x dual, 1 x 210 highlite element		STANDART
*4	2 x 145 Highlite, 1 x dual, 1 x 210 highlite element with timer		
*5	2 x 145 Highlite, 1 x 210, 1 x oval highlite element		
*6	2 x 145 Highlite, 1 x 210, 1 x oval highlite element with timer		
9	1 x 145 Highlite, 1 x 180, 1 x dual, 1 x oval highlite element		STANDART
10	1 x 145 Highlite, 1 x 180, 1 x dual, 1 x oval highlite element with timer		STANDART OR SLIDER CONTROL
*11	2 x 145 Highlite, 1 x dual, 1 x oval highlite element		
*12	2 x 145 Highlite, 1 x dual, 1 x oval highlite element with timer		
*13	2 x 145 Highlite, 1 x 210 dual, 1 x oval highlite element		
*14	2 x 145 Highlite, 1 x 210 dual, 1 x oval highlite element with timer		
*17	2 x 145 Highlite, 1 x triple, 1 x dual highlite element		
*18	2 x 145 Highlite, 1 x triple, 1 x dual highlite element with timer		
*19	2 x 145 Highlite, 1 x oval, 1 x triple highlite element		
*20	2 x 145 Highlite, 1 x oval, 1 x triple highlite element with timer		

*: Available upon request with warranty of a certain amount.

60cm Vitroceramic Hob with Front Triangular Touch Control (FRTR)			
HOB ID	CONFIGURATION	ELEMENT PLACEMENT	CONTROL SYSTEM
1	2 x 145, 2 x 180 highlight element		STANDART OR SLIDER CONTROL
2	2 x 145, 1 x 180, 1 x 180 dual highlight element		STANDART
3	2 x 145, 1 x 180, 1 x 210 highlight element		STANDART OR SLIDER CONTROL
4	2 x 145, 1 x 210, 1 x 180 dual highlight element		STANDART
5	2x145,1x180,1xoval highlight		STANDART
6	2 x 145, 1 x 180 dual, 1 x oval highlight element		STANDART
7*	2 x 145, 1 x 210, 1 oval highlight element		STANDART
8	2 x 145, 1 x 180, 1 x 180 dual highlight element with timer		STANDART
9	2 x 145, 1 x 180 dual, 1 x oval highlight element with timer		STANDART
10	2 x 145, 1 x 180, 1 x 210 triple highlight element with timer		STANDART OR SLIDER CONTROL
11	2 x 145, 1 x 180 dual, 1 x 210 triple highlight element		STANDART
12	2 x 145, 1 x oval, 1 x 210 triple highlight element		STANDART
13	1 x 145, 1 x 180, 1 x 290 triple highlight element		STANDART
14*	2 x 145, 1 x 210 dual, 1 x 180 dual highlight element		STANDART
15*	2 x 145, 1 x 210 dual, 1 x 180 dual highlight element with timer		STANDART
22*	1x145, 1x180, 1x210 highlight element		STANDART
23*	1x145, 1x180, 1x210 dual highlight element		STANDART
24*	1x145, 2x180 highlight element		STANDART
25	1 x 145, 1 x 180, 1 x 290 dual highlight element		STANDART
26	1 x 145, 1 x 180, 1 x 290 dual highlight element with timer		STANDART OR SLIDER CONTROL
27	2 x 145, 2 x 180 highlight element, timer		STANDART
35	1 x 145, 1 x 180, 1x290 highlight element, timer		SLIDER CONTROL

*Available upon request

60cm Vitroceramic Hob with Side Touch Control (SDTC)			
HOB ID	CONFIGURATION	ELEMENT PLACEMENT	CONTROL SYSTEM
1	2 x 145, 2 x 180 highlight element		STANDART
2	2 x 145, 1 x 180, 1 x 180 dual highlight element		STANDART
3	2 x 145, 1 x 180, 1 x 210 highlight element		STANDART
4	2 x 145, 1 x 210, 1 x 180 dual highlight element		STANDART
5*	2 x 145, 1 x 180, 1 x oval highlight element		STANDART
6*	2 x 145, 1 x 180 dual, 1 x oval highlight element		STANDART
7*	2 x 145, 1 x 210, 1 oval highlight element		STANDART
9*	2 x 145, 1 x 180 dual, 1 x oval highlight element with timer		STANDART
10*	2 x 145, 1 x 180, 1 x 210 triple highlight element		STANDART
14*	2 x 145, 1 x 210 dual, 1 x 180 dual highlight element		STANDART
15*	2 x 145, 1 x 210 dual, 1 x 180 dual highlight element with timer		STANDART

*Available upon request

60cm Vitroceramic Hob for Combi Built-in Oven (POLY)			
HOB ID	CONFIGURATION	ELEMENT PLACEMENT	CONTROL SYSTEM
4	2 x 145, 2 x 180 highlight element		None
5*	2 x 145, 1 x 180, 1 x 180 dual highlight element		None
6*	2 x 145, 1 x 180, 1 x 210 triple highlight element		None
7*	2 x 145, 1 x 180 dual, 1 x 210 triple highlight element		None
8*	2 x 145, 1 x oval, 1 x 210 triple highlight element		None
9	2 x 145, 1 x 180 dual, 1 x oval highlight element		None
10*	2 x 145, 1 x 180, 1 x oval highlight element		None
11	2 x 145, 1 x 180, 1 x 210 highlight element		None
12*	2 x 145, 1 x 210, 1 x 180 dual highlight element		None
13*	2 x 145, 1 x 210, 1 oval highlight element		None
14*	2 x 145, 1 x oval, 1 x 210 dual highlight element		None

*Available upon request

60cm Vitroceramic Hob with Side Knob Control (SDKB)			
HOB ID	CONFIGURATION	ELEMENT PLACEMENT	LIMITATIONS
1	2 x 145, 2 x 180 highlight element		None
2	2 x 145, 1 x 180, 1 x 180 dual highlight element		None
3	2 x 145, 1 x 180, 1 x 210 highlight element		None
4	2 x 145, 1 x 210, 1 x 180 dual highlight element		None
5*	2 x 145, 1 x 180, 1 x oval highlight element		None
6*	2 x 145, 1 x 180 dual, 1 x oval highlight element		None
7	2 x 145, 1 x 210, 1 oval highlight element		None

*Available upon request

OVENS&HOBS//SPECIFICATIONS

60cm Side Controlled Solid Hotplate and Polyvalente Built-in Electric Hob Configurations			
HOB ID	CONFIGURATION	LIMITATIONS	ELEMENT PLACEMENT
01	2 x 145, 2 x 180 hotplate	None	
02	2 x 145, 1 x 180, 1 x 180 rapid hotplate	None	
03	1 x 145, 1 x 145 rapid, 1 x 180, 1 x 180 rapid hotplate	Not available for polyvalente type hob	
*04	1 x 145, 1 x 145 rapid, 2 x 180 hotplate	Not available for polyvalente type electric hob	

60CM SIDE CONTROLLED SOLID HOTPLATE HOBS ARE AVAILABLE FOR TABLE TOP
 *: Available upon request with warranty of a certain amount.

60cm Side Controlled Gas Hob Configurations			
HOB ID	CONFIGURATION	LIMITATIONS	ELEMENT PLACEMENT
31	1 x Auxiliary, 1 x Semi Rapid, 1 x Rapid Burner, 1 x Hotplate	Not available for gas on glass hob	
40	1 x Auxiliary, 2 x Semi Rapid, 1 x Rapid Burner	None	
41	1 x Auxiliary, 2 x Semi Rapid, 1 x Triple Flame Burner	None	

60CM SIDE CONTROLLED GAS HOBS ARE AVAILABLE FOR TABLE TOP APPLICATION

60cm Front Controlled Gas Hob Configurations			
HOB ID	CONFIGURATION	LIMITATIONS	ELEMENT PLACEMENT
31	1 x Auxiliary, 1 x Semi Rapid, 1 x Rapid Burner, 1 x Hotplate	Model I not available for gas on glass hob	
40	1 x Auxiliary, 2 x Semi Rapid, 1 x Rapid Burner	None	
41	1 x Auxiliary, 2 x Semi Rapid, 1 x Triple Flame Burner	None	

30cm Gas On Glass Hob Configurations		
HOB ID	CONFIGURATION	ELEMENT PLACEMENT
10	1 x Triple Flame Burner	
20	1 x Auxiliary, 1 x Rapid Burner	

60cm Pure Design Combined Hobs Configurations			
HOB ID	CONFIGURATION	LIMITATIONS	ELEMENT PLACEMENT
62	2 Gas Heaters (1 x Rapid & 1 x Semi Rapid) 2 HiLight Heaters (1X180 & 1X145)	Available for only side knob control	
64	2 Gas Heaters (1 x Rapid & 1 x Auxiliary) 2 HiLight Heaters (1X180 & 1X145)	Available for only side knob control	
66	3 Gas Heaters (1 x Semi Rapid & 1 x Auxiliary & 1 x Rapid) 1 HiLight Heater (1X180)	Available for only side knob control	
67	3 Gas Heaters (1 x Semi Rapid & 1 x Auxiliary & 1 x Rapid) 1 HiLight Heater (1X180 DUAL)	Available for only side knob control	
69	2 Gas Heaters (1 x Rapid & 1 x Semi Rapid) 2 Induction Heaters with timer 1X200 (Nominal 2100W max.Boost 2500W) 1X160 (Nominal 1400W max.Boost 1800W)	Available for only side control. Touch control is standard for induction heaters, knob control is standard for gas heaters.	

90cm Front Controlled Gas Hob Configurations			
HOB ID	CONFIGURATION	LIMITATIONS	ELEMENT PLACEMENT
51	1 x Auxiliary, 2 x Semi Rapid, 1 x Rapid, 1 x Triple Flame Burner (MONO)	None	
53	2 x Auxiliary, 2 x Semi Rapid, 1 x Rapid, 1 x Triple Flame Burner (DUAL)	None	

70cm Front Controlled Gas Hob Configurations			
HOB ID	CONFIGURATION	LIMITATIONS	ELEMENT PLACEMENT
50	1 x Auxiliary, 2 x Semi Rapid, 2 x Rapid Burner	Not available for Plus x	
51	1 x Auxiliary, 2 x Semi Rapid, 1 x Rapid, 1 x Triple Flame Burner	None	

30cm Induction Hob Configurations		
HOB ID	CONFIGURATION	ELEMENT PLACEMENT
24	1 x 160 mm, 1400 / B1800W induction element 1 x 200 mm, 2100 / B2500W induction element	
25	1 x 160 mm, 1400 / B1800W induction element 1 x 200 mm, 2100 / B2500W induction element with timer	

30cm Solid Hotplate Hob Configurations			
HOB ID	CONFIGURATION	ELEMENT PLACEMENT	LIMITATIONS
05	1 x 145, 1 x 180 hotplate		None
*06	1x145 rapid hotplate, 1x180 rapid hotplate		
*07	1x145rapid hotplate, 1x180 hotplate		
08	1x145 hotplate, 1x180 rapid hotplate		None

30cm Vitroceramic Hob Configurations		
HOB ID	CONFIGURATION	ELEMENT PLACEMENT
16	1 x 180 Highlight, 1 x 145 Highlight element	
17	1 x 180 Dual, 1 x 145 Highlight element	
19	1 x 180 Highlight, 1 x 145 Highlight element with timer	
20	1 x 180 Dual, 1 x 145 Highlight element with timer	









*: Available upon request with warranty of a certain amount.



































ALL ELEMENT CONFIGURATIONS ARE APPLICABLE FOR BOTH KNOB CONTROL AND TOUCH CONTROL UNIT

















	Built-in Oven Add_on Limitations Table (60lt or 65lt)							
	I Type Add_on		U Type Add_on		O Type Add_on	O Type	Mono Stripe Add_on	O Type
	Inox Control Panel	Glass Control Panel	Inox Control Panel	Glass Control Panel	Inox Control Panel	Glass Control Panel	Inox Control Panel	Glass Control Panel
17 mm					N/A	N/A		
	Laser Cut	Laser Cut	Laser Cut	Laser Cut			Laser Cut	Laser Cut
50 mm								
	Cladding	Cladding	Cladding or Laser Cut	Cladding	Cladding	Cladding or Laser Cut	Laser Cut	Laser Cut
65 mm					N/A	N/A	N/A	N/A
	Cladding	Cladding	Cladding	Cladding				
80 mm	N/A	N/A	N/A	N/A	N/A	N/A		
							Laser Cut	Laser Cut
85 mm	N/A	N/A	N/A	N/A			N/A	N/A
					Cladding	Cladding		
100 mm	N/A	N/A	N/A	N/A	N/A	N/A		
							Laser cut	Laser cut















Duo Stripe Add_on	Trio Stripe Add_on	Corner Add_on	Visio Touch Add_on	Visio Display Add_on	Smart LCD Add_on
Glass Control Panel	Glass Control Panel	Glass Control Panel	Glass Control Panel	Glass Control Panel	Glass Control Panel
Laser Cut	Laser Cut	Laser Cut	Laser Cut	Laser Cut	Laser Cut













OVENS&HOBS//SPECIFICATIONS

Built-in Oven Add_on Limitations Table (75lt)									
	I Type Add_on		U Type Add_on		O Type Add_on O Type		Mono Stripe Add_on O Type		Duo Stripe Add_on
	Inox Control Panel	Glass Control Panel	Inox Control Panel	Glass Control Panel	Inox Control Panel	Glass Control Panel	Inox Control Panel	Glass Control Panel	Inox Control Panel
17 mm	N/A	N/A			N/A	N/A	N/A	N/A	N/A
			Laser Cut	Laser Cut					
40 mm							N/A	N/A	N/A
	Cladding	Cladding	Cladding	Cladding	Cladding	Cladding			
50 mm	N/A	N/A	N/A	N/A	N/A	N/A			
							Laser Cut	Laser Cut	Laser Cut

















		ENAMELLED PAN SUPPORTS					CAST IRON PAN SUPPORTS				
		S-type	V-type	O-type	K-type	D-type	S-type Cast Iron	W-type Cast Iron	K-type Cast Iron	Extenda Cast Iron	
		0°	0°	45°	45°	0°	0°	45°	45°	0°	
SIDE CONTROLLED HOBS	FLAT (R, S type)								N/A	N/A	N/A
	FLAT (T type)								N/A	N/A	
	SURFACE								N/A	N/A	N/A
	SMOOTHLINE				N/A	N/A		N/A	N/A	N/A	N/A
	NEW FREESTANDING								N/A	N/A	N/A
	DIVISION		N/A	N/A	N/A	N/A	N/A		N/A	N/A	N/A

		ENAMELLED PAN SUPPORTS					CAST IRON PAN SUPPORTS				
		S-type	V-type	O-type	K-type	D-type	S-type Cast Iron	W-type Cast Iron	K-type Cast Iron	Extenda Cast Iron	
		0°	0°	45°	45°	0°	0°	45°	45°	0°	
FRONT CONTROLLED HOBS	30 cm Domino			N/A	N/A	N/A	N/A		N/A	N/A	N/A
	60 cm Model1			N/A	N/A		N/A	N/A		N/A	
	70 cm Model1			N/A	N/A	N/A	N/A	N/A		N/A	
	60 cm Plusx			N/A	N/A	N/A	N/A		N/A	N/A	N/A
	70 cm Plusx			N/A	N/A	N/A	N/A		N/A	N/A	N/A

		ENAMELLED PAN SUPPORTS					CAST IRON PAN SUPPORTS			
		Mono, Standard	Mono, Plusx	Mono, Profile	Mono Cast Iron	Mono Cast, Plusx	Line Cast Iron	Deluxe Cast Iron	S-type Cast Iron	
										
SIDE CONTROLLED GAS SECURIT HOBS		45°	45°	45°	45°	45°	0°	45°	0°	
	SECURIT II 4G		✓	✓	✓	✓	✓	N/A	N/A	N/A
	SECURIT II		✓	✓	✓	✓	N/A	N/A	N/A	N/A
	SECURIT II TRIO		✓	✓	✓	N/A	✓	N/A	N/A	N/A
	PURE DESIGN 2GAS+2 VITRO		✓	✓	✓	✓	✓	N/A	N/A	N/A
	PURE DESIGN 3GAS+1 VITRO		✓	✓	✓	✓	✓	N/A	N/A	N/A
	PURE DESIGN 2GAS+2 IND		✓	✓	✓	✓	✓	N/A	N/A	N/A
DIVISION		N/A	N/A	N/A	N/A	N/A	N/A	N/A	✓	

		ENAMELLED PAN SUPPORTS			CAST IRON PAN SUPPORTS					
		Lama Mono, Standart	Plusx Mono, Plusx	Mono, Profile	Mono Cast Iron	Mono Cast, Plusx	Line Cast Iron	Deluxe Cast Iron	S-type Cast Iron	S-type Cast Iron
										
		45°	45°	45°	45°	45°	0°	45°	0°	0°
FRONT CONTROLLED GAS SECURIT HOBS	SECURIT 30 cm DOMINO 	A	A	A	N/A for Wok	A	N/A	N/A	N/A	N/A
	SECURIT 60/70 cm MODEL 1 	A	A	A	A	N/A	N/A	N/A	N/A	N/A
	SECURIT 60/70 cm PLUSX 	A	A	A	A	A	A	N/A	N/A	N/A
	SECURIT 90 cm 	N/A	N/A	N/A	N/A	N/A	N/A	N/A	N/A	N/A

Knob Limitation Table Built-in Cookers					
		BUILT-IN	Side Controlled HOB	Front Controlled HOB	DOMINO S-I / S-II
ALFA		✓	✓	✓	✓
ANTERO		✓	Knob with ring Not applicable to Hob range	Knob with ring Not applicable to Hob range	Knob with ring Not applicable to Hob range
BUYUK ANTERO		✓	✓	✓	✓
BIG MACRO RING		✓	Knob with ring Not applicable to Hob range	Knob with ring Not applicable to Hob range	Knob with ring Not applicable to Hob range
BIG MACRO		✓	✓	✓	Not suitable for Domino range. (Alternative - Small Macro)
BIG RIMO		✓	✓	✓	✓
BIG TRIO		✓	✓	✓	✓
DELTA		✓	✓	✓	✓
DELTA RING		✓	Knob with ring Not applicable to Hob range	Knob with ring Not applicable to Hob range	Knob with ring Not applicable to Domino range
ECLIPSE		✓	✓	✓	✓
ECLIPSE RING		✓	Knob with ring Not applicable to Hob range	Knob with ring Not applicable to Hob range	Knob with ring Not applicable to Domino range
EPSILON		✓	Knob with ring It's not applicable to Hob range	Knob with ring It's not applicable to Hob range	Knob with ring Not applicable to Domino range
FEROUS		✓	No use	No use	No use
GAMA		✓	✓	Height of knob is not suitable for FC range	✓
GAMA RING		✓	Knob with ring Not applicable to Hob range	Knob with ring Not applicable to Hob range	Knob with ring Not applicable to Domino range
JANNU		✓	✓	✓	✓
JANNU RING		✓	Knob with ring Not applicable to Hob range	Knob with ring Not applicable to Hob range	Knob with ring Not applicable to Hob range

Knob Limitation Table Built-in Cookers					
		BUILT-IN	Side Controlled HOB	Front Controlled HOB	DOMINO S-I / S-II
NORD		✓	✓	Height of knob is not suitable for FC range	✓
NORD RING		✓	Knob with ring Not applicable to Hob range	Knob with ring Not applicable to Hob range	Knob with ring Not applicable to Domino range
OMEGA		✓	Knob with ring Not applicable to Hob range	Knob with ring Not applicable to Hob range	Knob with ring Not applicable to Domino range
PIPO		✓	Pop in-Pop out mechanism is not available for Hob range.	Pop in-Pop out mechanism is not available for Hob range.	Pop in-Pop out mechanism is not available for Domino range.
RIMO		✓	Knob with ring Not applicable to Hob range	Knob with ring Not applicable to Hob range	Knob with ring Not applicable to Domino range
RUSTIC RISUS (without ring)		✓	✓	Height of knob is not suitable for FC range	✓
RUSTIC RISUS (with ring)		✓	Knob with ring Not applicable to Hob range	Knob with ring Not applicable to Hob range	Knob with ring Not applicable to Domino range
SMALL MACRO (with ring)		✓	Knob with ring Not applicable to Hob range	Knob with ring Not applicable to Hob range	Knob with ring Not applicable to Domino range
SMALL MACRO (without ring)		✓	Not suitable for Hob range. (Alternative - Big Macro)	Not suitable for Hob range. (Alternative - Big Macro)	✓
SPECTRUM		✓	Knob with ring Not applicable to Hob range	Knob with ring Not applicable to Hob range	Knob with ring Not applicable to Domino range
TRIO		✓	Knob with ring Not applicable to Hob range	Knob with ring Not applicable to Hob range	Knob with ring Not applicable to Domino range
VESTA		✓	✓	Height of knob is not suitable for FC range	✓
VARIO		✓	✓	✓	✓
VARIO RING		✓	Knob with ring Not applicable to Hob range	Knob with ring Not applicable to Hob range	Knob with ring Not applicable to Domino range
ZENITH		✓	No use	No use	No use
ZETA		✓	✓	✓	✓
ZETA RING		✓	No use	No use	No use

INSTALLATIONS

INSTALLATION OF BUILT-IN OVEN

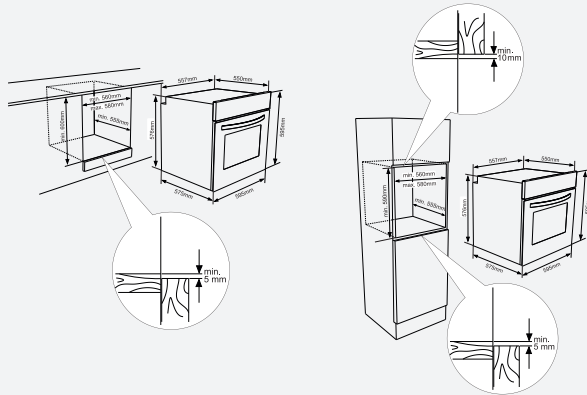

INSTALLATION OF COMBI VITROCERAMIC HOB AND BUILT-IN OVEN

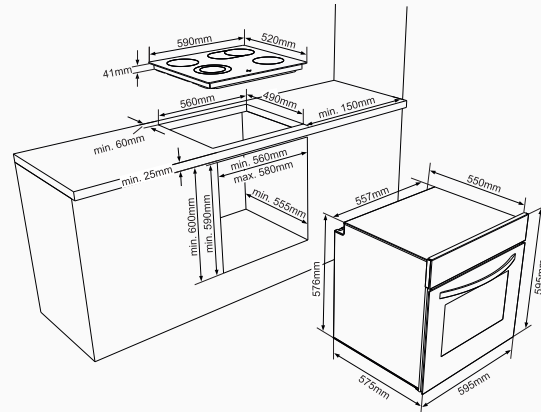

INSTALLATION OF COMBI ELECTRIC HOB AND BUILT-IN OVEN

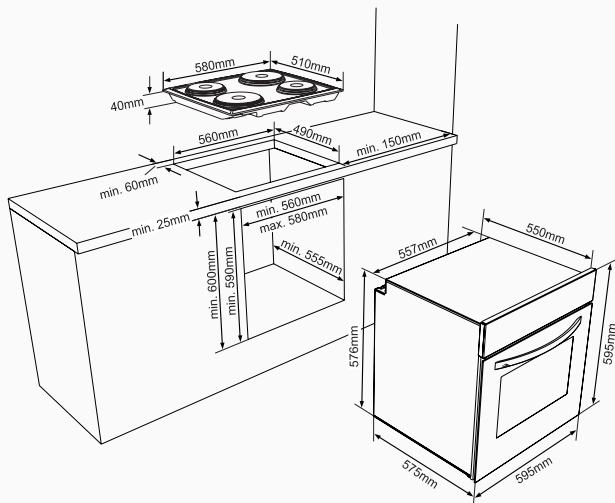

INSTALLATION OF COMBI INDUCTION HOB AND BUILT-IN OVEN

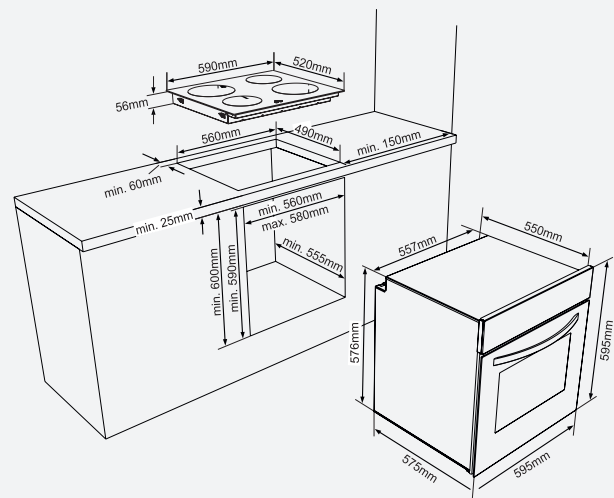

INSTALLATION OF NEW GENERATION 90CM INDUCTION HOB

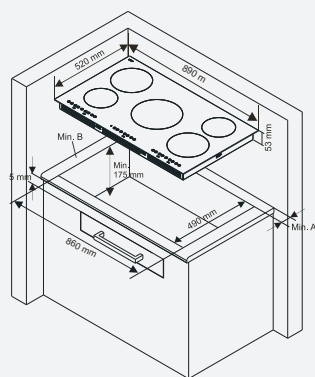

Neighbourhood walls	A [mm]	B [mm]
Wood	60	150
Concrete or ceramic tiled	25	40

* In the case of installation over built in oven, distance should be min. 10 mm.

90CM GAS ON GLASS HOB WITH FRONT CONTROL INSTALLATION

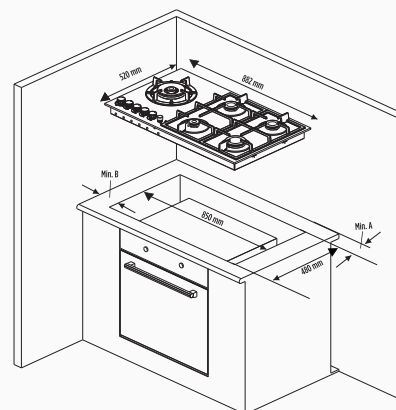

Neighbourhood walls	Min. A	Min. B
Combustible	80 mm	180 mm
Non-combustible	60 mm	80 mm

INSTALLATION OF NEW GENERATION 78CM INDUCTION HOB

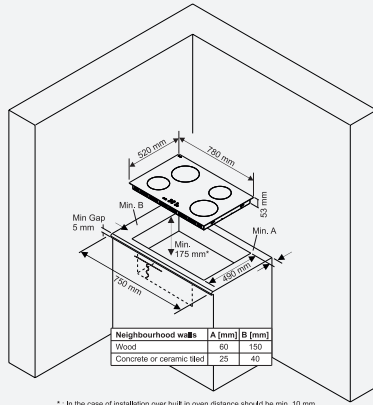

* In the case of installation over built in oven, distance should be min. 10 mm.

INSTALLATION OF 78CM INDUCTION HOB

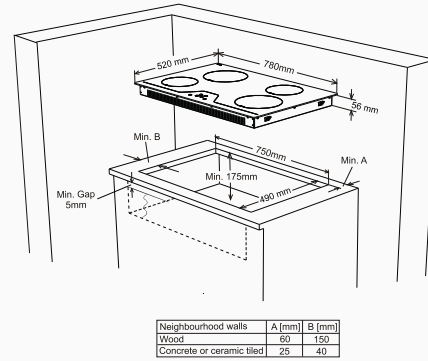

INSTALLATION OF 78CM VITROCERAMIC HOB WITH FRONT TOUCH CONTROL

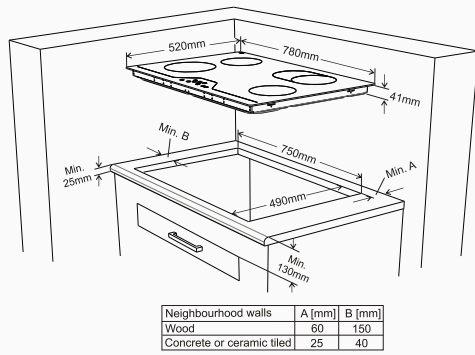

70CM GAS HOB WITH FRONT CONTROLLED PLUSX DESIGN

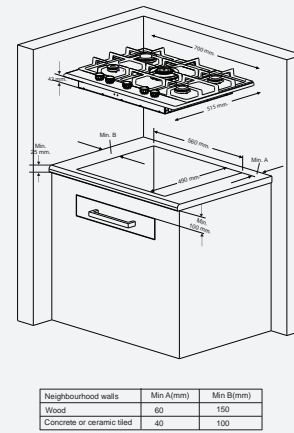

INSTALLATION OF 70CM GAS ON GLASS HOB WITH FRONT CONTROLLED PLUSX DESIGN

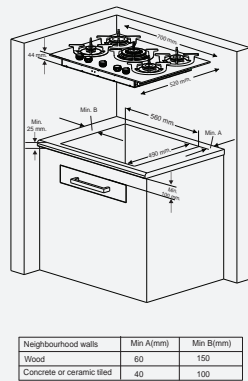

INSTALLATION OF 70CM GAS ON GLASS HOB WITH FRONT CONTROL

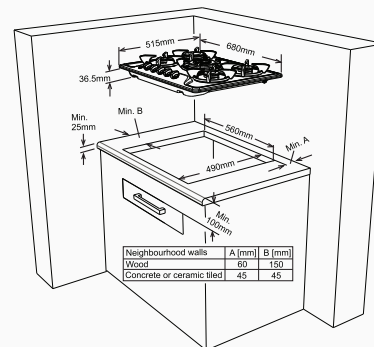

INSTALLATIONS

INSTALLATION OF 70CM GAS HOB WITH FRONT CONTROL

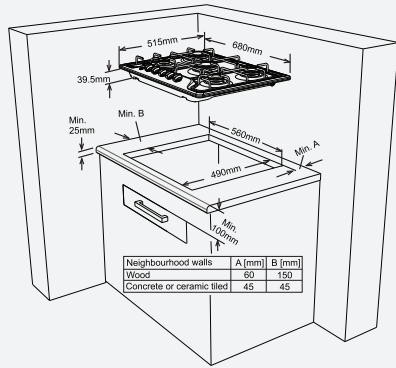

INSTALLATION OF NEW GENERATION 60CM INDUCTION HOB

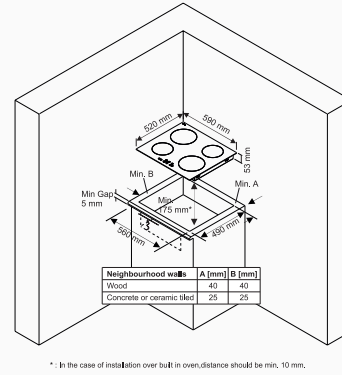

INSTALLATION OF 60CM INDUCTION HOB

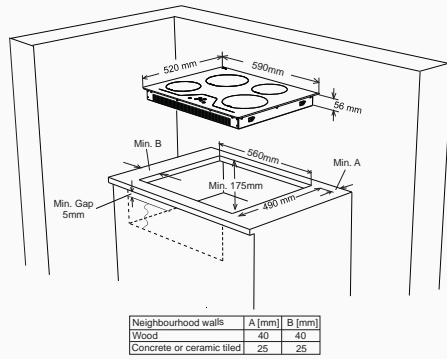

INSTALLATION OF 60CM VITROCERAMIC HOB WITH TRIANGULAR TOUCH CONTROL

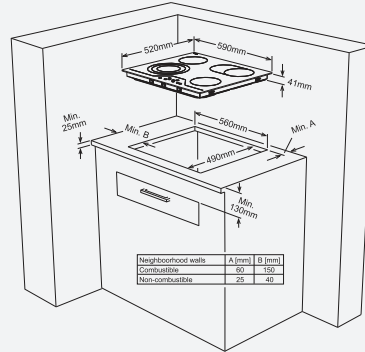

INSTALLATION OF 60CM VITROCERAMIC HOB WITH SIDE KNOB CONTROL

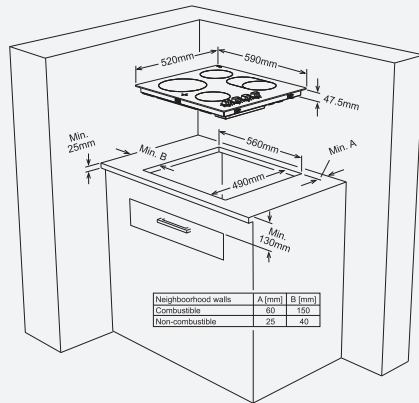

INSTALLATION OF 60CM VITROCERAMIC HOB WITH FRONT TRIANGULAR TOUCH CONTROL (1X180, 1X45, 1X270, TRIPLE ZONE)

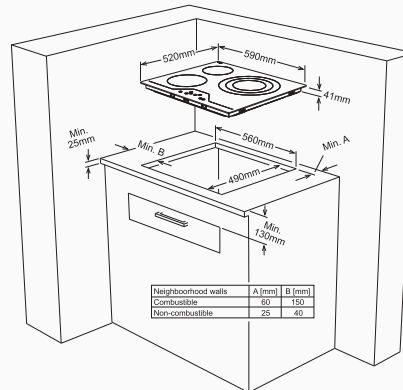

60CM GAS & VITROCERAMIC ON GLASS HOB WITH SIDE CONTROL PURE DESIGN

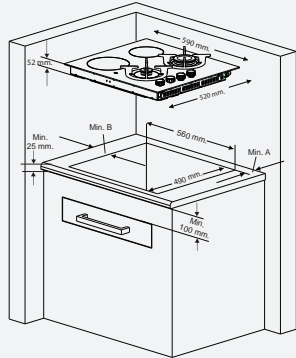

Neighbourhood walls	Min A(mm)	Min B(mm)
Wood	60	150
Concrete or ceramic tiled	40	50

60CM GAS & INDUCTION ON GLASS HOB WITH SIDE CONTROL PURE DESIGN

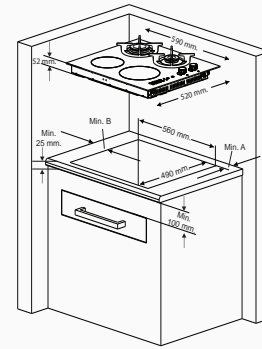

Neighbourhood walls	Min A(mm)	Min B(mm)
Wood	60	150
Concrete or ceramic tiled	40	50

60CM GAS ON GLASS HOB WITH FRONT CONTROLLED PLUSX DESIGN

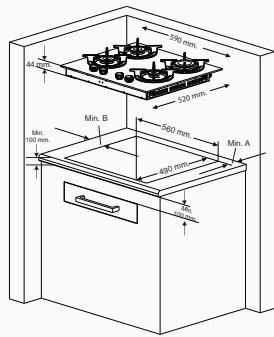

Neighbourhood walls	Min A(mm)	Min B(mm)
Wood	60	150
Concrete or ceramic tiled	40	50

INSTALLATION OF 60CM GAS HOB WITH FRONT CONTROLLED PLUSX DESIGN

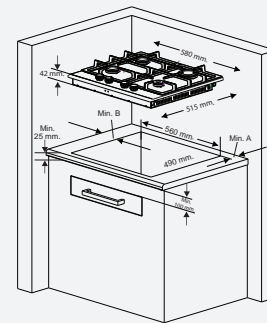

Neighbourhood walls	Min A(mm)	Min B(mm)
Wood	60	150
Concrete or ceramic tiled	40	50

INSTALLATION OF 60CM GAS ON GLASS HOB WITH SIDE CONTROL SERIE 2

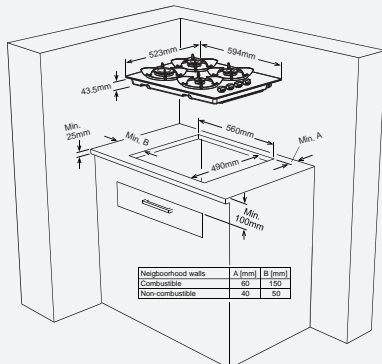

Neighbourhood walls	A (mm)	B (mm)
Combustible	60	150
Non-combustible	40	50

INSTALLATION OF 60CM GAS ON GLASS HOB WITH SIDE CONTROL

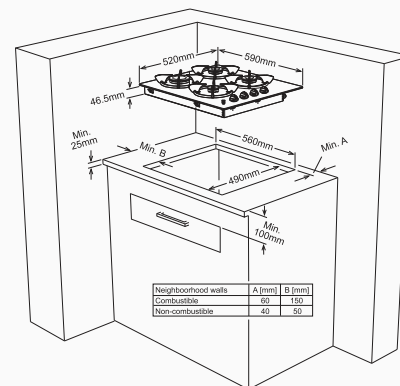

Neighbourhood walls	A (mm)	B (mm)
Combustible	60	150
Non-combustible	40	50

INSTALLATIONS

INSTALLATION OF 60CM GAS ON GLASS HOB WITH FRONT CONTROL

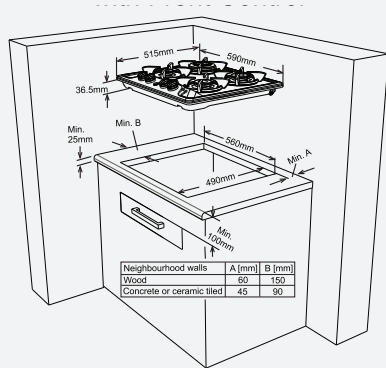

INSTALLATION OF 60CM GAS HOB WITH SIDE CONTROL

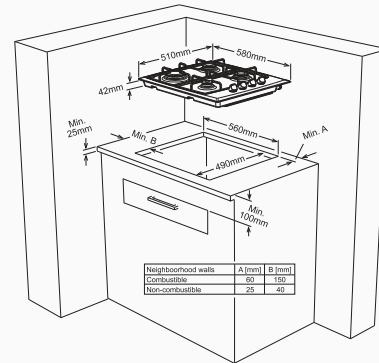

INSTALLATION OF 60CM GAS HOB WITH FRONT CONTROL

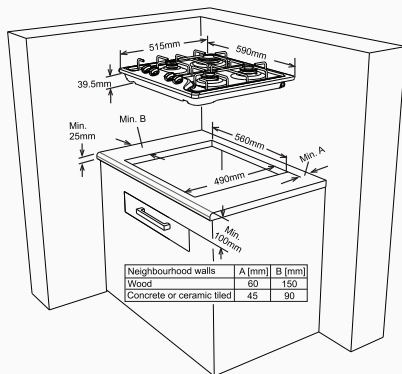

INSTALLATION OF 60CM ELECTRIC HOB WITH SIDE CONTROL

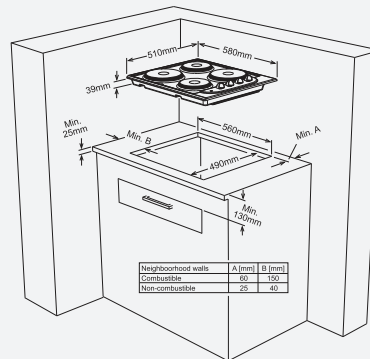

INSTALLATION OF NEW GENERATION 30CM INDUCTION DOMINO HOB WITH TOUCH CONTROL

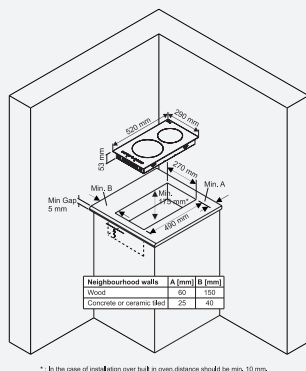

* In the case of installation over built-in oven, distance should be min. 10 mm.

INSTALLATION OF 30CM INDUCTION DOMINO HOB WITH TOUCH CONTROL

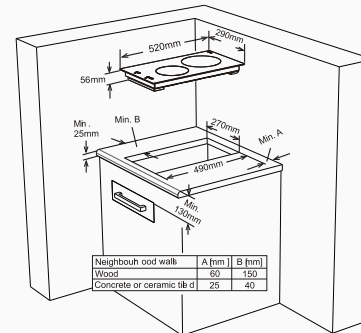

INSTALLATION OF 30CM VITROCERAMIC DOMINO HOB WITH TOUCH CONTROL

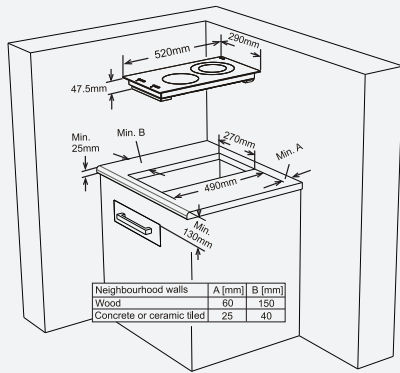

INSTALLATION OF 30CM VITROCERAMIC DOMINO HOB WITH KNOB CONTROL

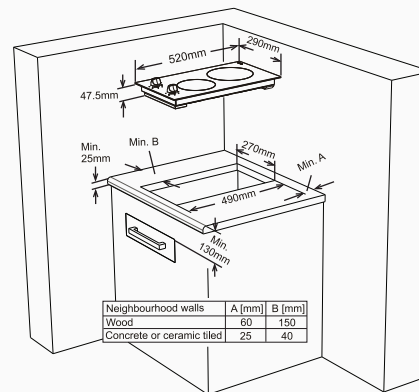

INSTALLATION OF 30CM GAS ON GLASS DOMINO HOB

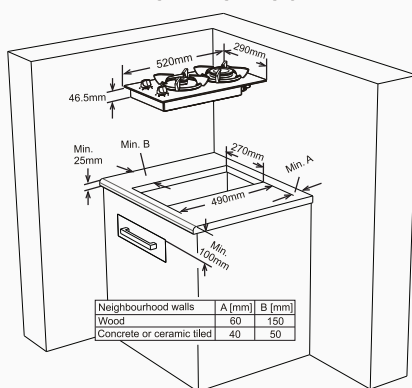

INSTALLATION OF 30CM DOMINO GAS HOB WITH FRONT CONTROL (SERIE2)

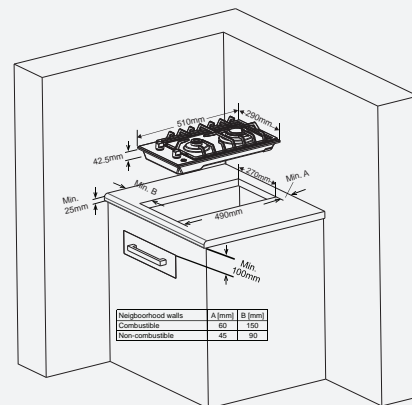

INSTALLATION OF 30CM ELECTRIC HOB WITH FRONT CONTROL

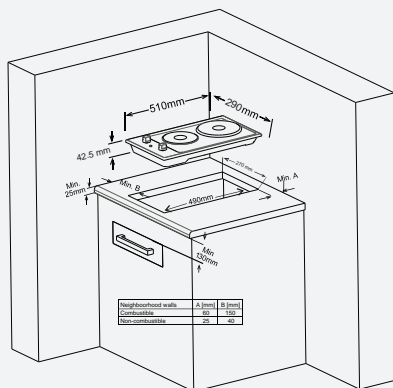

Vestel Trade Co.

Organize Sanayi Bölgesi, 45030 Manisa/Türkiye

Phone: 90 - 236 233 25 82

Fax: 90 - 236 233 25 84

vesteltrade@vestel.com.tr

www.vestel.com.tr

Vestel Benelux B.V.

P.O. Box 29179 3001 GD - Rotterdam / Netherlands

Phone: 31 - 10 235 1000

Fax: 31 - 10 235 1003

info@vestelbenelux.nl

www.vestelbenelux.nl

TOO Vestel Central Asia

Dostyk Avenue, 132 , Office 6, Almaty/Kazakhstan

Phone: 7 - 727 262 83 01

Vestel CIS Ltd.

1-st Graivoronovsky Proezd, No.20 Building 16, 109518,
Moscow /Russia

Phone: 7 - 095 956 8230

Fax: 7 - 095 956 8233

info@vestel.ru

www.vestel.ru

Vestel Electronica

Str Zidarului nr 9-11, Sector 5 Bucuresti, ZIP 051765

Bucharest/Romania

Phone: 40 - 31 425 42 93

Fax: 40 -31 425 42 95

office@vestel.ro

www.vestel.ro

Vestel France S.A.

17 Rue de la Couture-Silic BP 10190-94563 RUNGIS

Cedex/France

Phone: 33 - 1 46 75 00 29

Fax: 33 - 1 41 80 99 31

p.benhamou@vestel-france.fr

Vestel Germany GmbH

Parkring 6 85748 Garching b. München/Germany

Phone: 49 - 89 55295 - 0

Fax: 49 - 89 55295 - 2000

info@vestel-germany.de

www.vestel-germany.de

Gruppo Industriale Vesit SPA

Via polidoro da Caravaggio, 6, 20156 - Milano/Italy

Phone: 39 - 02 842 48577

Fax: 39 - 02 842 48617

info@givesit.it

www.givesit.it

Vestfrost Household

Spangsbjerg Mollevej 100, DK-6705 Esbjerg 0, Denmark

Phone: 45 - 7610 4045

Fax: 45 - 7610 4046

Vestel Iberia

Avda, Partenon, 16-18 Planta 1 Oficina 6, 28042 Madrid/
Spain

Phone: 34 -91 320 63 98

Fax: 34 -91 320 52 58

vestel@vestel.es www.vestel.es

Vestel Poland

Poleczki 33, 02-822 Warszawa, Mazowieckie

Phone: 48 22 2555700

info@vestel-poland.com

Vestel Scandinavia

Postikatu 4, FI-04400 Järvenpää / Finland

Phone: 358 - 46 712 2262

Fax: 358 - (0) 9 251 7 8222

Vestel UK Ltd

Vestel House, Waterside Drive

Langley, Berkshire SL3 6EZ

Phone: 44 - 3330 146 400

info@vestel-uk.com

www.vestel.co.uk

United Technical Services

S.R.O. ul. Seneckâ 16, 91101 Samorin, Slovakia

Phone: 421- 31 590 27 31

Fax: 421- 31 590 27 38

info@uts.sk

www.uts.sk

VESTEL

Organize Sanayi Bölgesi, 45030 Manisa/Türkiye

Phone: 90 - 236 233 25 82 **Fax:** 90 - 236 233 25 84

vesteltrade@vestel.com.tr

www.vestel.com.tr